



National *RADIO* News

Vol. 6—No. 8

WASHINGTON, D. C.

June-July 1935

IN THIS ISSUE

Cathode Ray Oscillograph

The first of a series of articles on this subject by Joseph Kaufman, N. R. I. Supervisor of Education

Opportunities in the Field of Radio Servicing and Merchandising

By J. G. Hollingsworth, N. R. I. Vocational Director

Metal Tubes



Shadow Boxing

"Mr. Smith," said my visitor, "the greatest obstacle to be overcome by young men today is *Shadow Boxing*."

"Now," he continued, "let me explain what I mean. When a boxer is in training he must develop speed and wind. He will, quite frequently, go through the entire routine of the

ring, all alone in the gymnasium. He jabs and hooks, and ducks and blocks, even muttering at an imaginary adversary. His punches hit only the air—his mutterings go unheeded because no one hears them. He is really fighting 'nothing.'

"Take the average young fellow, for example. He wants to make good. His ambition is all right, except it is misdirected. He is always trying something new. He doesn't stick with one idea long enough to learn what it is about before he jumps at something new. He does not put his mind to any one thing and *make a go of it*. That's what I mean, Mr. Smith, by *Shadow Boxing*."

That was one of the best lessons I've had passed on to me in a long time. It is absolutely true that many young men, and older men, too, are jumping about trying to whip an imaginary foe—wasting their punches on the air when they should be using the energy to prepare for successful careers.

Shadow Boxing is essential in the fight industry, but not in any other. The fellow who says, "I'll study tomorrow, tonight I've got to do something else," is *Shadow Boxing*. So is the man who lays aside his lessons for the summer, intending to catch up in the fall. A man who studies Radio today, traffic management tomorrow, and Latin the next day is *Shadow Boxing*.

The successful man these days must *specialize*. It takes all of his time to **KNOW HIS ONE SUBJECT**. The minute he starts *Shadow Boxing* he loses time—permits someone else to gain on him.

Make punches count. Hit only at obstacles which may retard your progress to your success goal—and then *hit hard*. Unless you are contemplating a career as a professional boxer—**DON'T INDULGE IN SHADOW BOXING**.

J. E. Smith,

President

The Cathode Ray Oscillograph and Its Use in Radio Servicing

by J. Kaufman,
N. R. I. Supervisor
of Education

Part 1, How the Oscillograph Works

TO have or not to have a cathode ray oscillograph is a problem now facing servicemen. So much is being written about this device that it is best to start this series of articles with a few words regarding its indispensability.

First let me say that it is not an indispensable service tool. Practically all of the jobs that can be done with it can be accomplished with some other indicator; some of the receiver defects that it reveals can be determined by simple tests and a little radio servicing experience. But this much can be said about the cathode ray oscillograph technique; it may cut the service time manifold or give you an insight to a defect that may be difficult to realize without it.

A cathode ray oscillograph and the necessary associated equipment are fairly costly; the life of the tube is limited besides being rather expensive. Therefore from an economic point of view, it must be purchased on the basis that it will save time, assuming that time is worth money to you. The device belongs in every large service shop, at the jobber's wholesale service bench, or where a large number of high fidelity receivers are to be serviced. A busy serviceman may gain a lot of time to devote to other jobs or to take care of the business side of the servicing work, if he learns to use this device correctly. The instrument should not be allowed to idle, and thus waste the useful life of the tube.

Let me say a few words to the beginner or the man starting out in the service profession. The cathode ray oscillograph is not in the same class as the all-wave oscillator, the multimeter and the various socket break-in analyzers, for it is a helpful addition and to my way of thinking nothing else. So don't let your present ability and confidence in tackling a job be dampened by the fact that you don't have one.

Some of Its Uses

I think you will be better able to appreciate these articles if you realize, even at the start only in a superficial way, some of its uses. The cathode ray tube produces a beam of electrons impinging (hitting) a special screen which glows, usually green. The beam invariably is moved up and down on the screen by the current or voltage that is being analyzed, and the variation spread horizontally by a special "sweep" current or voltage. If we use only the vertical movement, we may measure peak voltages or currents; if we also use the sweep-

ing current or voltage we may see the desired current or voltage wave form. I will come back to this in greater detail.

With this basic instrument and a few auxiliary devices we can:

1. Measure peak voltage or current.
2. Visualize current or voltage wave form.
3. Determine frequency and phase.
4. Band pass, peak and align I.F. and R.F. stages.
5. Adjust B supply vibrators.
6. Check overload and distortion.
7. Check intermittent conditions of reception.
8. Isolate defective stages.
9. Determine overall receiver response.
10. Measure modulation percentage.
11. Trace hum origin.

I will consider most of these procedures, once the fundamentals of the device are explained; the way the others are obtained will then be quite obvious.

How the Cathode Ray Tube Works

The tube itself looks like a large glass funnel, totally closed, the air removed to a reasonable vacuum and in some cases a little argon gas introduced. Thus we have gas and vacuum type cathode ray tubes. The reason for the gas will be shortly explained. Although there are many types of cathode ray tubes, those used in the testers designed for servicemen may be considered as having: 1, an electron emitter *E*; 2, an electron beam concentrator *W.C.*; 3, an accelerating electrode or anode *A*; 4, a vertical (up and down) set of deflecting plates *D_v*; 5, a horizontal (side to

(Page 8, please)

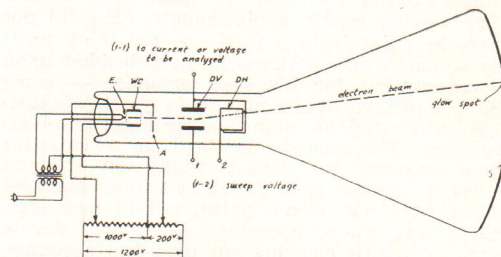

Figure 1



E. R. Haas,
Vice-President and
Director

A Few Words With the N.R.I. Director

Putting Your House in Order

THERE was a time, not so many years ago, when the Radio serviceman had trouble keeping busy in the summer time. This was due, chiefly, to two causes. Many families were away on vacations, and their Radios were not used. Consequently, there was no service work on these sets. Then, also, summer time reception was so poor that even when people were home, they paid slight heed to Radio entertainment.

But these conditions have undergone quite a change. Summer time reception is much better. Summer programs have been improved. And those who do not stay at home, are using automobile Radios. Therefore, the alert Radio serviceman of today finds plenty to do to keep him busy in the summer.

In fact, the business-minded Radio serviceman will usually find the summer months the busiest of the year. Not alone will he take advantage of the big opportunities offered by automobile Radio and other summer time business possibilities which Radio of today offers, but he gives thought to putting his house in order.

For instance, during the rush winter months things around the shop or office got broken. They needed repair, replacements. He did not have the time to do it then—he put it off until the summer. Or perhaps he had decided upon rearrangement for his shop or office — some changes which would make his place of business more efficient, more comfortable, more attractive. The summer is the time to care for these matters—get them straightened out and in order for the rush fall and winter business ahead. He will clean, paint, put in new electric wiring where necessary — he will devote extra effort to clearing up over-due accounts, consequently getting his books in better shape.

Page Four

And he will use any surplus time that he might have on his hands, in making plans and preparing for the rush season ahead.

Look over your place of business—make a list of the things which need to be done—which should be done — so that your business can operate more smoothly next fall. But while you are putting your house in order, don't overlook your regular service business; don't forget that people are now summer time Radio listeners, both at home and in their automobiles—and there's no reason why Radio service work should not be available in the summer time, in a volume almost equivalent to the winter months.

— n r i —

And while we are discussing the possibilities of summer time earnings for Radio, it is well to bear in mind that aeriols, particularly those on tall apartment buildings which are exposed all winter to the worst the elements have to offer, are sometimes in very poor condition by the time the warm weather sets in.

Set owners using those aeriols, therefore, become good prospects for new, all-wave aerial installations.

— n r i —

WHAT THE NATIONAL HOUSING ACT MEANS TO YOU

Because the United States Government, under the National Housing Act, is insuring loans made to home owners, millions of dollars in heretofore frozen assets, will be available from various financing agencies. This money is going into circulation.

The loans obtained will be used under two broad classifications; for modernization of existing homes, and for new home construction.

Under the regulations of the Housing Act, the home owner may spend the money advanced to him for labor and material involved in the actual building of any permanent improvement to his property. By that we mean he could use it to repair, improve, or install new plumbing. He could electrify his property, or replace old electric wiring. The money could be used even to purchase new linoleum, which is attached to, and thus may be considered a "built-in" part of the property.

On the other hand, he is not permitted to use the money to buy curtains, furniture, or a

(Page 18, please)

Easy Measurement Charts

By J. A. Dowie,
N. R. I. Chief Instructor

Simple formulas and charts for calculating values of combined, fixed and variable condensers to give a required capacity

Just as it is sometimes found convenient to connect resistances in series or parallel to obtain a certain value of resistance in a circuit, so it is often desirable to connect condensers in series or parallel to obtain the desired value of capacity; but in this case, however, the total capacity is not calculated the same way as in the case of resistances. That is, if two or more condensers are connected in parallel, their capacities are added to obtain the resultant capacity; but if they are connected in series, the resultant capacity is then less than that of any one of them.

When there are only two condensers connected in series the resultant capacity can be calculated by the following formula:

$$(1) \quad C = \frac{C_1 \times C_2}{C_1 + C_2}$$

This means that the resultant capacity C is equal to C₁ multiplied by C₂, divided by C₁ plus C₂, where C₁ and C₂ are the two capacities connected in series.

For example: If a 500 mmf.* (.0005 mf.*) condenser is connected in series with a 750 mmf. (.00075 mf.) condenser the resultant capacity will be 300 mmf. (.0003 mf.) as

$$C = \frac{500 \times 750}{500 + 750} = \frac{375000}{1250} = 300 \text{ mmf.}$$

By using the accompanying charts A and B for condensers in series, which is based on formula (1), the resultant capacity may be easily solved.

All you need to do is to draw a straight line from one known capacity value picked out on the left hand scale to the value of the second capacity on the right hand scale, and the resultant capacity value can be read off at the point where the line you have drawn intersects the center scale.

Chart A covers the range of .0002 mf. (200 mmf.) to .006 mf. (6,000 mmf.). Chart B covers the range of .002 mf. (2,000 mmf.) to .05 mf. (50,000 mmf.).

The correct use and value of these charts is best illustrated by working out an example.

Suppose it is desired to know the resultant capacity of a .00025 mf. and a .0005 mf. condenser connected in series. Connect these values

by a straight line between the outside scales and read the answer at the intersection on the middle scale which is in this case .000168 mf.

To obtain the resultant capacity of more than two condensers connected in series, first find the resultant capacity of two of these in series by using charts A or B, and considering this as a single condenser, combine it with a third condenser, and so on.

For example: Suppose you had three condensers connected in series using the capacities in micro-microfarads of 400 mmf., 500 mmf., and 1,000 mmf.

Chart A shows us that the 400 mmf. and 500 mmf. resultant capacity will be equivalent to a single 225 mmf. condenser. Now consider the 225 mmf. and 1,000 mmf. condenser in series.

Chart A again shows us that the resultant capacity will be equivalent to a 185 mmf. condenser. Hence the 400 mmf., 500 mmf., and 1,000 mmf. condensers connected in series have a resultant capacity equivalent to a single 185 mmf. condenser.

(Page 6, please)

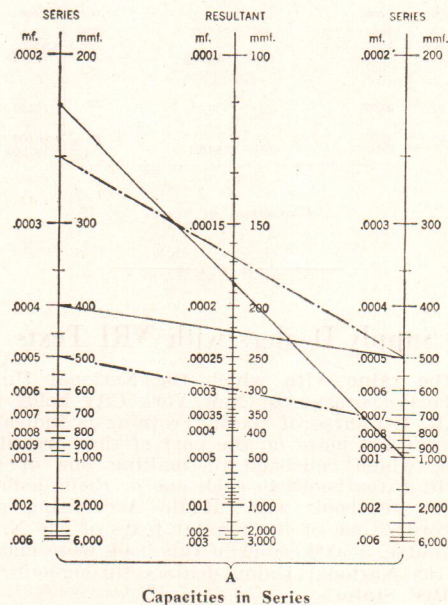

Easy Measurement Charts

(Continued from page 5)

The ranges of these two charts may be extended by the use of a suitable multiplier as was done with the two resistance charts in the Feb.-Mar. 1935 edition of NATIONAL RADIO NEWS.

The students for whom this article was written are advised to keep these charts handy for future reference, as they will eliminate wrestling with complicated formulas should you want to find the resultant capacity of two or more condensers connected in series.

*mmf. means micro-microfarads.

*mf. means microfarads.

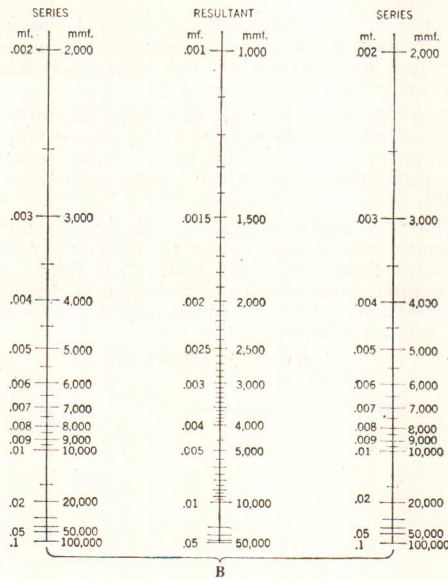

Capacities in Series

Supply Dealers with NRI Texts

The value with which the National Union Tube Corporation of New York City holds the N. R. I. Course of Radio Training is indicated by a recent move on the part of that organization, which consisted of mailing one of the N. R. I. textbooks to each one of their dealers.

The textbook was "Radio Accounting and Records," one of the regular texts of the N. R. I. Course. 15,000 copies of this book were mailed to the National Union dealers throughout the United States.

Page Six

Special Data Sheet

NATIONAL RADIO NEWS will bring to its readers, in the next issue, a very helpful data sheet, one which has been in demand for a long time.

There are a number of Radio manufacturing organizations like General Electric, Westinghouse, RCA Victor, etc., which manufacture or sell Radio receivers in Canada. While the sets sold in Canada bear different model numbers, quite frequently the circuits are the same as sets sold in the United States.

Numerous circuit diagrams, published by the manufacturers in the United States, can therefore be used by N. R. I. students and graduates in Canada, provided they know which of the circuits are alike. It is the plan of this new data sheet to analyze the circuit and give you a cross reference on the Canadian and American sets for which the same circuit diagram may be used.

The chart will be as nearly up-to-date as it is possible to obtain information.

n r i

ELECTROSTATIC MICROPHONES

The D. R. Bittan Sales Company, Inc., 27 Park Place, New York City, has called to our attention an Electrostatic Microphone for which they claim the following advantages:

No inherent noise; immune to temperature changes; unaffected by atmospheric moisture; no cavity resonance, high impedance; operates at 200 feet or more from an amplifier without a pre-amplifier.

For information regarding this equipment, write direct to the D. R. Bittan Sales Company, Inc., at the address given above.

n r i

NOVEL MICROPHONE BY AMPERITE

The Amperite Corporation, 561 Broadway, New York City, has recently announced a Junior Velocity microphone which is about the size of a matchbox and which can be suspended around the neck of a speaker. Weight is only eight ounces. Frequency response 60 to 7500 cycles and output of 68 db. on open line. Cable can be any length up to 2000 feet.



**SILVERTONE MODEL 1700
AND 7062 REMOVING
LOUDSPEAKER**

The loudspeaker can be removed for replacement by taking off the 6A7 tube shield and removing the three speaker mounting screws. Be certain that the speaker lead color code is followed. Improper connection will cause excessive hum due to the hum bucking coil increasing hum instead of cancelling it out.

— n r i —

**SILVERTONE MODEL 1700
AND 7062 SPEAKER
RATTLE**

This may be caused by the cone being off center. Loosen the center adjusting screw, insert four 1/8" wide strips of heavy writing paper between the pole piece and the inside of the voice coil, retighten the adjusting screw, and remove the paper facing strips. All metal parts of the chassis (including the A.C., D.C. switch) are at high potential to ground. Do not attempt to attach a ground connection to the chassis and do not touch the chassis while the line cord is plugged in to an outlet unless you wear a pair of rubber gloves.

— n r i —

**SILVERTONE MODEL 1700
AND 7062 INCREASING
SENSITIVITY**

Increased pick-up can be had by splicing the antenna lead to an additional length of wire or to a regular antenna if available.

— n r i —

SILVERTONE MODEL 1670 HUM

A slight amount of hum, which disappears when a carrier is tuned in, is normal in this model. Severe hum, which becomes increased when a carrier is tuned in, and poor sensitivity, are a definite indication of a faulty type 56 detector tube. Sometimes interchanging the position of the 56 tubes will eliminate the hum. If it does not, the tubes must be replaced. It is particularly important that a good ground is used with this model to minimize hum.

— n r i —

**SILVERTONE MODEL 1650,
1652 and 1654 INCREASING
SELECTIVITY**

If you have had any complaints in your locality on the selectivity of this receiver it can be improved by disconnecting the two leads to

the small choke in the first I.F. circuit and inserting in its place a .005 microfarad condenser. After this has been done the I.F. stages must be rebalanced with an oscillator. The latter procedure is very important, as the purpose of the condenser substitution will be lost unless the I.F. stages are carefully rebalanced.

— n r i —

**SILVERTONE
MODEL 1640 ELIMINATION OF
HISS OR FEEDBACK**

In this set employing a 283 type tube reception can often be improved by inserting a choke coil in the red plate lead of the 83 tube circuit. In some instances this tube may cause interference in the set in which it is being used as well as in other sets used in proximity to it. If in any event the use of one choke does not eliminate the trouble, a similar choke can be inserted in the other plate lead of the type 83 tube. The choke is part number R-8301 and can be ordered from the Colonial Radio Corporation, 254 Rano Street, Buffalo, New York.

— n r i —

**SILVERTONE MODEL DEFECTIVE 25Z5
1700, 1750 AND 7062**

The rectifier tube can be ruined by overloading of only a few seconds duration. When working on the receiver be very careful not to cause a short circuit that would increase the load on the 25Z5. In particular, use a non-metallic screwdriver when adjusting the I.F. tuning condensers. A metallic screwdriver will cause a short from plate to ground ruining the 25Z5. Some receivers of this model have a 200-ohm resistor, in the negative lead from the rectifier, connected from the speaker field and grid return of the power tube to the rest of the voltage divider which consists of a 150-ohm and 50-ohm resistors in series. This reduces the load on the 25Z5 from 90 milliamperes to a value of 80 milliamperes, by increasing the negative bias on the grids of the power tubes. The 200-ohm resistor should be added to those receivers which do not have it if difficulty is experienced with the 25Z5 tubes constantly wearing out.

— n r i —

**AUTOMOBILE RECEIV- COMPLETELY
ERS—ALL DEAD**

When an auto set is completely dead look for a burned-out fuse in the A lead to the

(Page 11, please)

Page Seven

side) set of deflecting plates D_H ; and 6, a fluorescent screen S . Figure 1 shows one type of tube made and extensively used in the U. S. A. I will shortly consider another popular make.

The electron emitter is a regular filament with its tip twisted or coiled, the tip covered with barium or strontium oxide which you should know emits electrons when heated. These small negative particles are drawn out by the anode A which is at a high positive potential, and the intensity of the beam (the space current) is increased by raising the anode or plate voltage. If the two sets of deflecting plates have no voltage difference applied, the beam will pass straight through the tube, impinging on the fluorescent screen (usually calcium tungstate) which then emits a green glow. The spot will be quite large and means are provided to control its size and brilliancy. This tube has a small amount of argon gas, which is ionized by the passage of the electrons. The freed electrons join the stream leaving the heavy positive gas ions. Any of the electrons that stray from the beam combine with the positive ions, making neutral argon. Thus the beam is concentrated or held in a close bundle. The gas effect is fixed by the tube designer.

The intensity of the beam may be increased by raising the anode voltage and such a control is often provided. To adjust the size of the spot a special electrode $W.C.$ is introduced. It is a little cylinder which surrounds the electron emitter; its ends are open. Technicians call it a "Wehnelt" cylinder after its originator. This tube is made negative and the greater the negative charge the larger the spot and the greater the spot brilliancy. The negative charge converges the beam through the hole in the anode, as illustrated in Fig. 2.

I previously said that the deflecting plates are used to move the spot on the screen. Everything else said so far is primarily to obtain a sharp distinct spot on the screen. Incidentally you must not allow the spot to remain at rest too long, otherwise the screen will burn at that point and a permanent black spot which will not glow will appear. The deflecting plates do the work that makes the cathode ray tube so

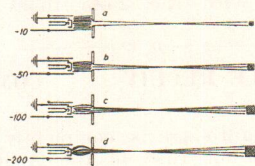

Figure 2

Page Eight

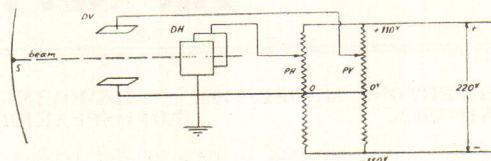

Figure 3

useful. Suppose a circuit as suggested by Fig. 3 is connected to the deflecting plates. If variable contacts P_V and P_H are placed at O , the electron beam will suffer no attraction or repulsion and the beam will impinge at the center of the screen as shown in Fig. 4A. As P_V is adjusted to $+110$ volts the spot will move upwards and reach a maximum as shown in Fig. 4B, because the electrons in the beam are attracted by the positive charged plate. If the upper plate is made negative by sliding P_V below O , then the spot will move down. Various positions are shown in Figs. 4A to 4G for various potentials on D_V and D_H , and the effects produced should be perfectly clear.

On the other hand, if a 60 c.p.s. voltage, 110 volts peak is connected to the D_V plates while no voltage is connected to the D_H plates the spot will rapidly move up and down and appear as a line, as shown in Fig. 4H. Because the up and down action is rapid, 60 complete cycles per second, a band or line instead of a movable spot as you might expect is seen. This condition exists because the eye cannot follow a change of more than 8 per second, although at least 15 changes per second is best for no flicker. This phenomenon is called persistence of vision. Now if you were to rapidly swing P_H from $+110$ to -110 , by wiggling the knob, the spot would spread out and you would observe a series of confusing waves. But if you could produce a voltage that would rise uniformly from $+110$ to -110 , exactly 60 times a second, a single cycle would appear on the screen as shown in Fig. 4I. This uniformly rising voltage is called the sweep voltage and when the pattern stands still you have synchronized or locked the sweep voltage with the analyzed voltage. The method of producing the sweep will be discussed shortly, but now I want to describe the other popular cathode ray tube.

Figure 5 shows a high vacuum cathode ray tube and the basic electrodes and controls. Again an electron emitter is used but in this case, a small ferrule with a recess covers the filament. Barium and strontium oxides are placed in the recess at E . The electrons are drawn out of the emitter by two anodes lettered A_1 and A_2 . The latter are of special construc-

(Next page, please)

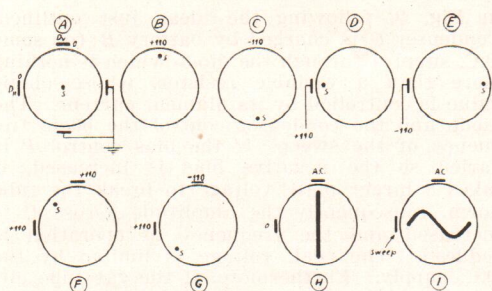

Figure 4

tion. They are two cylinders placed end to end. A_2 is larger than A_1 . The first anode has two circular discs, one at each end. When these anodes are positively charged, they create an electrostatic field which bends the beam into a close bundle, and if either voltage is regulated the bundle of electron rays converge to a point on the fluorescent screen. This is referred to as electrostatic focusing and is quite often compared to a camera lens in action. Hence the anodes accelerate the electron stream and focus it to a point on the screen. Either anode could be regulated although A_1 , which operates at a lower voltage than A_2 , is usually controlled. R_2 in Fig. 5 is the focusing circuit.

The brilliancy of the spot is varied by an electrode or grid placed near the electron emitter and between the latter and the first anode. By varying the negative bias (R_1 in Fig. 5) the space charge surrounding the cathode is aided or neutralized and the amount of electrons drawn over by the anode is under control. The vertical and horizontal deflecting plates are the same in action as for the first tube described.

The Vertical and Horizontal Amplifiers

Clearly the deflection of the spot on the screen from its center position is dependent on the voltage applied to the deflecting plates. In the average cathode ray tube made for service work the deflection is one inch for every seventy-five volts applied. As a matter of fact this is the sensitivity rating of a tube. If the screen of the tube is about $1\frac{1}{2}$ inches in radius, then voltages of 1.5×75 or 112.5 volts may be measured. If the spot could be initially moved down to the bottom by applying an initial 112.5 negative bias, then a voltage of 215 could be measured. As a rule, we want to measure A.C. voltages so we are limited to only one-half the total swing, or a peak value of 112.5 volts. Of course, deflections of $\frac{1}{8}$ inch would be just about distinguishable, and this corresponds to about 10 volts. When we come

to measuring the R.F. voltages in the I.F. stages, and the A.F. voltage at the output of the second detector of an ordinary receiver, especially when a small receiver input signal is applied, 10 volts is a large value. So some amplifying device is required in conjunction with the regular cathode ray tube.

To increase the sensitivity of the ordinary cathode ray tube, an amplifier for each pair of plates is needed. It is referred to as the horizontal or vertical amplifier, depending on which set of plates it feeds. The usual amplifier is of the type shown in Fig. 6, and contributes a voltage gain of about 40. With this amplifier the sensitivity of the cathode ray tube becomes 2 volts per inch, and voltage peaks of .25 volt are readily detected.

The circuit shown is one that is used in a popular cathode ray oscilloscope tester. As you will recognize upon tracing the circuit, a resistance-capacitance coupler is used, the circuit designed to have linear amplification from 6 to 90,000 c.p.s. When switch *S.W.* is placed on contacts 1-1, the amplifier is employed; when placed on contacts 2-2 the amplifier is not used. The potentiometer controls the degree of amplification, while R_2 is one means of shifting the spot on the screen.

The Sweep Circuit

To sweep the spot horizontally from left to right we need: *a*, a bias to first set the spot to the left (this is the usual practice); and *b*, a constant varying potential, as shown in Fig. 7, which will rise from 0 to about 215 volts. The frequency of this saw-tooth wave should be variable from 15 to 20,000 c.p.s. for analyzing audio frequencies. Furthermore, whatever system is selected to produce this saw-tooth wave should have some means of keeping it in step with the voltage or current we are analyzing.

A simple way of getting a saw-tooth voltage is to connect a condenser *C* and a resistor *R*, as shown in Fig. 8 to a D.C. supply. The con-

(Page 10, please)

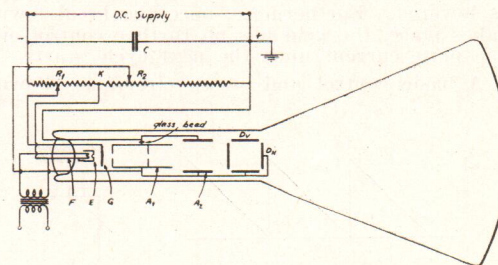

Figure 5

denser charges up, the process limited in time by the presence of resistor R . The rising volt-

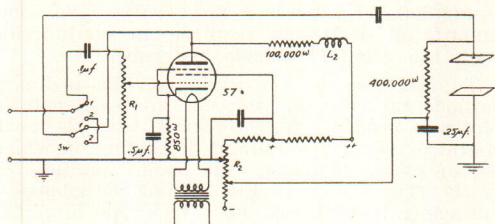

Figure 6

age is tapped off of C . The time to reach about 60 per cent of the applied voltage is determined by the time constant of RC (C in microfarads times R in megohms). By varying either R or C the time to reach this value may be controlled. Now we must introduce a condenser shorting switch to stop and start the process over and over again.

The solution to this problem is to be found in the modern gas triode, otherwise known as the thyratron or grid glow tube. When shown in a circuit diagram this tube is not distinguishable from an ordinary heater type triode, although the cathode is designed quite differently to withstand heavy bombardment of the gas ions produced. What is its unusual behavior which permits it to be used as an automatic switch? Assume first that it is connected in the usual way and with a fixed C bias. As the plate voltage is raised from zero, the plate current remains at zero until a critical plate voltage is reached. Then the current rises sharply and the plate-cathode resistance becomes very low. Now when the plate-cathode of a gas tube is connected to the charging condenser, the latter will be shorted at the critical voltage which is supplied by the condenser. What has the grid bias to do with this critical voltage? An important effect. If the grid bias is raised, so is the critical plate voltage; if it is lowered, then the critical breakdown voltage is lowered. Furthermore, once the breakdown takes place, the grid has no further control on the plate current until the next cycle starts.

A basic control and sweep circuit is shown

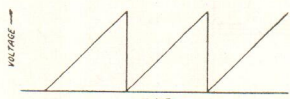

Figure 7

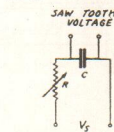

Figure 8

in Fig. 9, following the ideas just outlined. Condenser C is charged by battery B (or some D.C. supply) through the diode which is nothing more than a variable resistor, whose ohmic value is controlled by its filament current. The diode and the condenser control the basic frequency of the sweep. If the bias control P is varied so the negative bias is increased, it takes a larger plate voltage to break the tube down, consequently the amplitude across C is increased and the frequency of operation is reduced. The peak voltage is limited by the D.C. supply. Furthermore, if the gas tube circuit is adjusted for an approximate frequency, usually by adjusting its bias and plate voltage

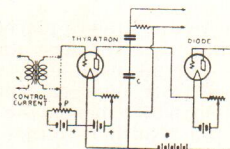

Figure 9

and altering the condenser and plate load resistor, the frequency of oscillation may be stabilized or synchronized by introducing into the grid a control current, a component of the signal to be analyzed. The frequency is then controlled by the applied signal, all other factors essentially controlling the sweep voltage amplitude.

I should mention that the diode is used to make the sweep voltage curve more linear. Usually an R.F. pentode is employed, the cathode and plate acting as the terminals of what is called a saturated tube resistance, and its value controlled by varying the C bias applied to its grid. In other cases a tube type resistor and a regular resistor are used together, the latter variable.

A Typical Cathode Ray Oscilloscope

The R.C.A. type TMV-122-B oscilloscope, widely used by servicemen, is shown in Figs. 10a and 10b, and embodies many of the basic features described. A 3 inch (R.C.A. type 906) cathode ray tube is used, getting its anode voltage from an 879 half wave rectifier (tube No. 3). Thirteen hundred voltage are produced, 1000 volts for the second anode, 300 volts for the first anode. Part of the 1300 volts is used to adjust the center or off position of the spot on the screen and part to adjust the cathode ray tube grid bias, hence the spot brilliancy.

A vertical and a horizontal amplifier are used, the gain in each case controlled by a grid input potentiometer. When an external synchroniz-

set. This is in some sets enclosed in a small bakelite container which can be unscrewed, revealing the fuse.

— n r i —

BRUNSWICK MODEL 17 DEAD

Check for a short to chassis of the 14,000-ohm screen resistor. This is located at the right of the chassis between two coil shields. Also check for a breakdown in the .5 microfarad condenser in the oscillator plate circuit.

— n r i —

GRUNOW MODEL 7A MOTORBOATING

Check the connections between the coil shield cans and the chassis. Dirt at this point will cause the trouble and a permanent cure may be made by grounding the can to the chassis with heavy wire.

— n r i —

LYRIC OLD MODELS

Those sets having a metal bottom plate should be carefully watched as the plate sometimes buckles shorting to parts. A piece of insulating paper should be inserted between the bottom plate and the chassis.

— n r i —

ATWATER KENT MODEL 612 DISTORTION

This is often due to an open volume control. Carefully check the control and replace with a new one if necessary.

— n r i —

ATWATER KENT MODEL 61 NOISY

Check the three filament resistors. These sometimes overheat burning through the insulation and shorting to the strip on which they are wound.

— n r i —

SPARTON MODEL 931 TUBES

Watch out for the wrong kinds of tubes in this set. The 84 is not inter-changeable with the 484 nor is the 82 inter-changeable with the 182. The 84 and 82 are modern rectifier tubes. National Union makes replacements for the 484 and 182 tubes.

— n r i —

CROSLEY MODEL 170 HIGH BACK GROUND NOISE LEVEL

Try shunting the 300,000-ohm resistor connected from the secondary of the I.F. trans-

former to the chassis with another. Weak signals on this model when voltages, currents and tubes check O.K. is often caused by an open in the grid return of the first R.F. tube. The break may be difficult to find but a continuity test between the various lengths of the lead will show up the trouble. If necessary remove the lead covering to expose the wire.

— n r i —

CLARION MODEL 360 LACK OF HIGH NOTES

This may be cleared up by removing the permanent tone control consisting of the condenser and resistor across the output circuit. The effect will be quite pleasing to some customers and when static is prevalent it may be cut down by using the variable tone control.

— n r i —

BOSCH MODEL 350 MODULATION HUM

If hum is only heard when tuning in signals check the ground of the filament supply. This connection is made through a rivet which is located approximately in the middle of the chassis shelf.

— n r i —

APEX, MODEL 8 DEAD OR INTERMITTENT RECEPTION

In most cases the oscillator causes this trouble in this model. The 50,000-ohm plate resistor should be checked, and replaced if open or off value 10% or more. Use a 2-watt resistor for replacement. Look for a charred condition in the resistor.

— n r i —

WURLITZER SA120 DEEP HOWL AND WEAK

When a deep bass howl occurs on this model, and it can be cleared up by varying the noise-suppressor control, then replace the 5. mfd 25-volt condenser which connects from the ground to the cathode of the "57" first audio, with a 5. mfd, 50-volt condenser. When this model shows weak reception and poor fidelity, pull out one of the 46 power tubes while the set is in operation. If signals come in louder, all voltages will be low, due to a shorted 5. mfd. 25-volt condenser, which connects from the ground to the center tap of the 2.5 volt filament on the second tap from chassis on the candohm resistor. Replace with a 50-volt condenser.

(Page 22, please)

All-Wave Radio in 2000 Rooms



The Waldorf-Astoria Hotel New York City. 2,000 guest rooms are supplied with 6-channel all-wave reception.

BY far the largest all-wave Radio receiving system in the world will become a reality at the Waldorf-Astoria Hotel, New York City, when the already elaborate Radio system, which the hotel has operated since its opening, is further augmented by short-wave receiving equipment now rapidly nearing completion.

The hotel's present system receives over the entire commercial or entertainment broadcast band. The new equipment perfected by the Western Electric Company will pick up the giant short-wave station used in world-wide broadcasting, such as those in London, Paris, Berlin, Moscow and Tokyo, as well as in Australia, South America and Africa.

According to the management, the Waldorf is the first hotel in the country to add short-wave broadcasts to its Radio service which is available in 2,000 private rooms.

A unique antenna, designed by engineers of the Bell Telephone Laboratories to pick up short waves with minimum interference, is strung between the hotel's two lofty towers 660 feet above street level. Two strands of wire cross to form an immense "X," while a third resembles an inverted "U." The strands are of different lengths and each responds to waves of related lengths, thus spreading their tentacles over the whole short-wave area.

Being horizontal, the antenna largely escapes interference from short-waves which, originating nearby, present a vertical electrical front. It takes advantage of the fact that short waves coming around the globe from distant stations are twisted so that they are as intense hori-

zontally as vertically. The wires are strung broadside to those points on the globe where the majority of short-wave stations are located.

From the lead-in wire, the Radio impulse surges 600 feet down in a special transmission line to the Radio room on the sixth floor. A vacuum tube "beats" it down from high frequency to 385 kilocycles. Its energy is now amplified 100,000,000,000 times and a high fidelity detector tube translates this Radio frequency into audio frequencies, the electrical equivalent of sound. Amplified once more, these frequencies pass into the hotel's present 6-channel program system.

The receiving units are designed for particularly high selectivity. The signal intercepted by the antenna is repeatedly filtered through tuning coils, condensers and vacuum tubes until the voice of the desired station, thousands of miles away, issues pure and clear. Numerous refinements make possible the accurate tuning required in the short-wave realm where channels may be separated by as little as .1 per cent, as for instance at 20,000 kilocycles, where the next station is only 20 kilocycles away. There are various devices to overcome the natural caprices of short-wave reception at great distances.

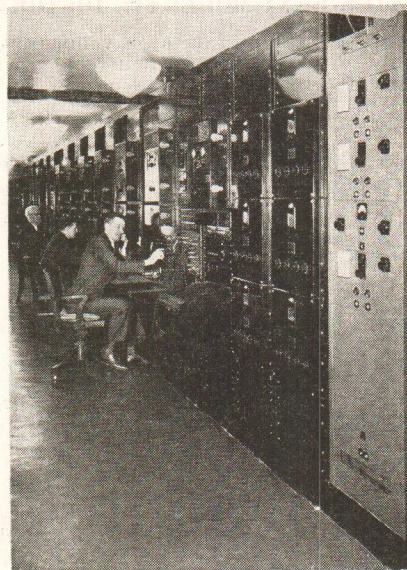

Radio room of the Waldorf-Astoria with three Radio men on duty.

RADIO-TRICIAN SERVICE SHEET

COMPILED SOLELY FOR STUDENTS & GRADUATES

RCA-VICTOR MODELS 140, 141, 141-E AND 240; GENERAL ELECTRIC K-80, K-80X, K-85; WESTINGHOUSE WR-30, WR-31; CANADIAN RCA-VICTOR 140; CANADIAN G. E. K-80, K-85; CANADIAN WESTINGHOUSE W83AW.

LINE-UP CAPACITOR ADJUSTMENTS

This receiver is aligned in a similar manner to that of a standard broadcast band receiver. That is, the three main tuning capacitors are aligned by means of three trimmers in each band and, on the three lowest frequency bands, a series trimmer is adjusted for aligning the oscillator circuit. The other two bands do not require this low-frequency trimmer, it being fixed in value. In the case of band D, it is necessary to adjust four trimmers, due to the additional R. F. stage used.

The chart on the right gives the details of all line-up adjustments. The receiver should be lined up in the order of the adjustments given on the chart. Refer to the diagrams below for the location of the line-up capacitors.

REMOVE FOUR NUTS & LOCKWASHERS SHOWN FOR REMOVING BOTTOM SHIELD OF COIL ASSEMBLY.

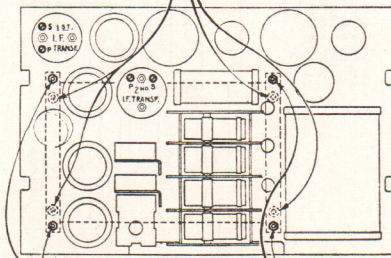

REMOVE FOUR NUTS & LOCKWASHERS TO REMOVE COIL ASSEMBLY.

Location of nuts and lockwashers holding

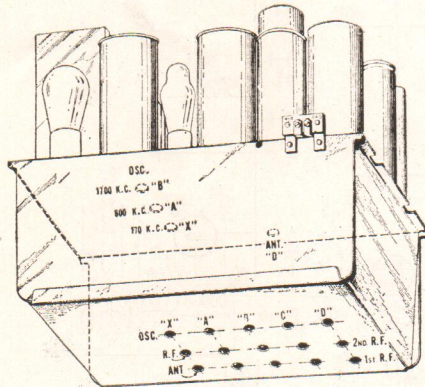

Location of line-up capacities

External Oscillator Frequency	Dial Setting	Location of Line-Up Capacitors	Position of Selector Switch	Adjust for	Number of Adjustments To be Made
445 K. C.	Any setting that does not bring in station.	At rear of chassis.	Any position that does not bring in station.	Maximum output.	4
370 K. C.	370 K. C.	Bottom of chassis.	X	Maximum output.	3
175 K. C.	Set for signal.	Top of chassis.	X	Maximum output while rocking dial back and forth.	1
1400 K. C.	1400 K. C.	Bottom of chassis.	A	Maximum output.	3
600 K. C.	Set for signal.	Top of chassis.	A	Maximum output while rocking dial back and forth.	1
3900 K. C.	3900 K. C.	Bottom of chassis.	B	Maximum output.	3
1710 K. C.	Set for signal.	Top of chassis.	B	Maximum output while rocking dial back and forth.	1
10 M. C.	10 M. C.	Bottom of chassis.	C	Maximum output. (See Note.)	3
15 or 18 M. C.	15 or 18 M. C.	Bottom and top.	D	Maximum output. (See Note.)	4

NOTE—It is important to note, when aligning bands C and D, that two peaks will be observed on the trimmers for the oscillator and for the first detector. The correct oscillator peak is the one obtained using the lower trimmer capacitance, whereas the correct detector peak is the one obtained with the higher capacitance. It is essential that the proper peak be chosen, as otherwise tracking and sensitivity will be very poor at other frequencies. When adjusting the detector trimmer, the tuning capacitor should be rocked, since there is a reaction on the oscillator tuning.

Readers who file Service Data in separate binders remove page carefully, trim on dotted line for same size as Data published heretofore.

NOTE—ON 4 BAND RECEIVER, CAPACITORS
 & COILS UNITS "X", ARE OBTAINED

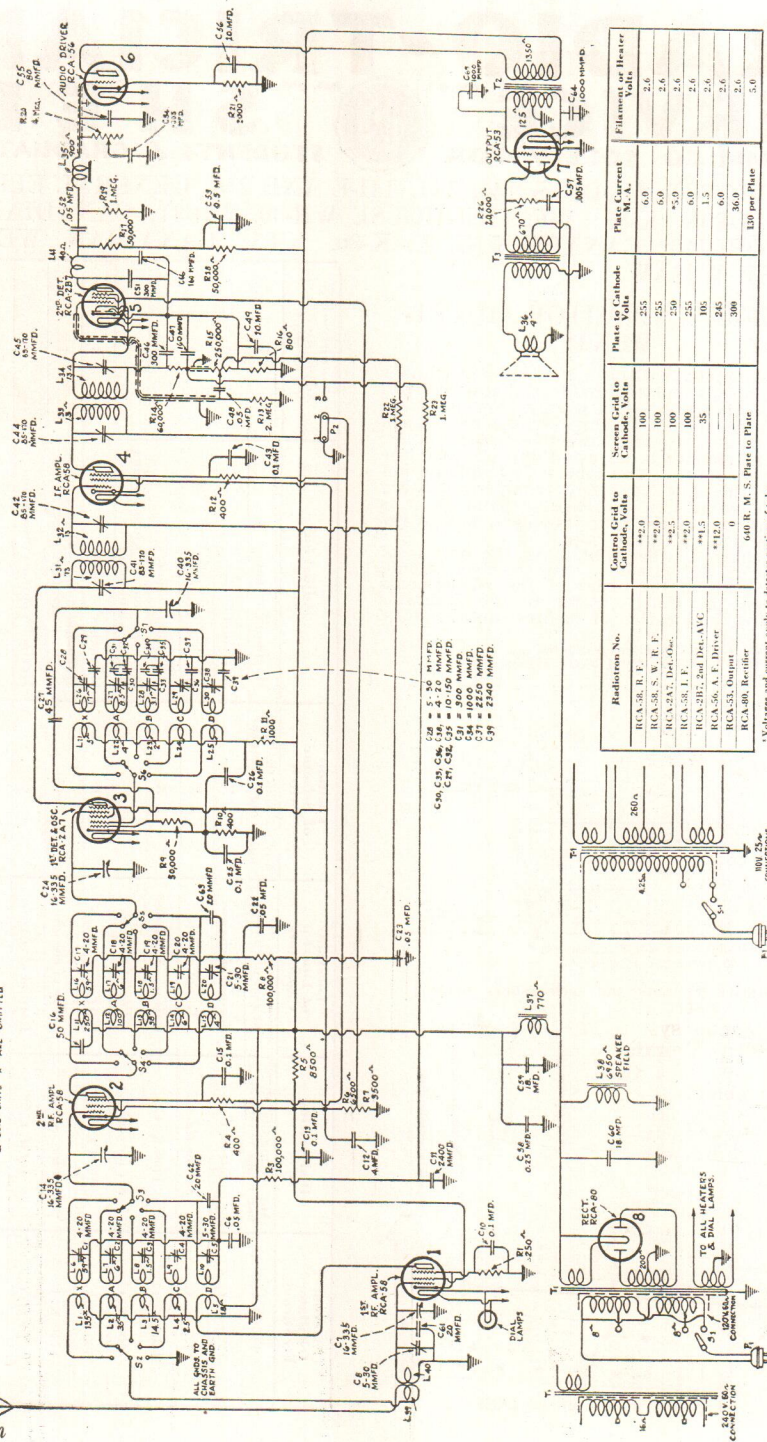

Rediaron No.	Control Grid to Cathode, Volts	Screen Grid to Cathode, Volts	Plate to Cathode, Volts	Plate Current, M. A.	Filament or Heater
RCA-58, R. F.	**2.0	100	255	6.0	2.6
RCA-58, S. W. R. F.	**2.0	100	255	6.0	2.6
RCA-2AT, Det. Amp.	**2.5	100	250	**2.0	2.6
RCA-58, I. F.	**2.0	100	255	6.0	2.6
RCA-3BT, 2nd Det. AVC	**1.5	35	100	1.5	2.6
RCA-56, A. F. Driver	**12.0	0	245	6.0	2.6
RCA-33, Output	0	0	300	30.0	2.6
RCA-80, Rectifier	50 R. M. S. Plate to Plate				5.0

* Voltages and current apply to detector portion of tube.
 ** These voltages cannot be measured because of the high resistance of the circuit.

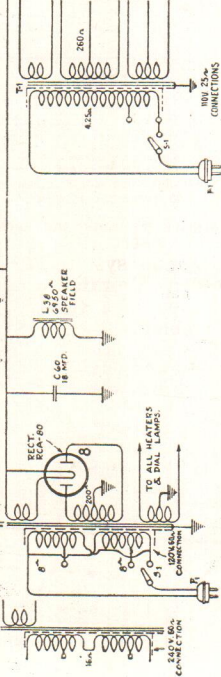

Running Around in Circles

By S. M. Armstrong, N. R. I. Student Service Director

A FAMOUS naturalist tells us that certain types of caterpillars move through the trees in a long procession, one leading and the others following, each one with his head against the tail of his predecessor. The gentleman, in experimenting with a group of these caterpillars, succeeded in getting the first caterpillar connected with the last, and so forming a circle which he started moving around a large vase.

The naturalist expected that after a while they would get tired of their useless march and start off on their own road. But not so. Instinct was followed so blindly that the circle kept moving around that vase for seven days and nights. They were following their instinct, but they were following it blindly. Just running around in circles—getting nowhere fast.

There are plenty of people in this world who do the same thing. They follow the same routine, day in, day out; week after week. One year is just like the last one. They follow because it is just a bit troublesome to seek a newer, better path—a path that leads somewhere.

Humanity has its instincts. They sometimes lead us in a course that is very much like a mongrel pup chasing its tail. He seldom does

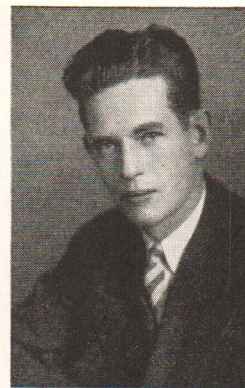

S. M. Armstrong

catch up with it—but if he does—so what? If he catches it he bites it and gets hurt. It just doesn't make sense.

Yes, as humans, we all too frequently go round and round without reason or profit. We wind up where we started, dizzy from the whirl. Nature has given humans intellect to supplement their instincts, but nature has not yet devised a way to MAKE all humans use that intellect.

Get off the merry-go-round! Travel the straight line. It is the shortest path to your SUCCESS GOAL. Have a definite objective and work toward it. Leave the circles to the caterpillars and the tail-chasing dogs.

— n r i —

BELDEN ANNOUNCES NEW ALL-WAVE AERIAL SYSTEM

AFTER extensive study of the elements necessary in the construction of an efficient noise reducing antenna system for all-wave reception, the Belden Manufacturing Company, 4689 W. Van Buren St., Chicago, announces the new 8917 Doublet Antenna System. This new aerial is virtually noiseless, and while it is intended primarily for short-wave reception, it makes the doublet type aerial suitable for broadcast receivers.

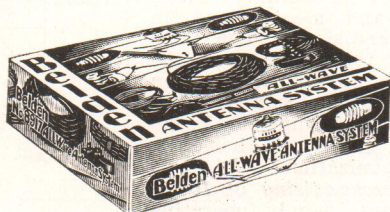

The unit is pre-assembled, both arms of the aerial being securely soldered to the doublet lead-in at the triangular transposition block. Insulators are attached and corrected lengths are provided to give most efficient service with the Belden Variable All-Wave Receiver Antenna Coupler which is included with the set. The Belden Variable Coupler provides a tuneable doublet antenna system with high efficiency and effective noise elimination at all frequencies. This unit eliminates the need for double or multiple span antennas that occupy large areas and are hard to install. It is completely shielded to assure freedom from noise pickup.

The Belden All-Wave Antenna System is provided in an attractive display carton. The same equipment is also furnished unattached in Belden No. 8918 Aerial Kit for those who prefer to make the complete assembly themselves.

THE OPPORTUNITIES in the Field of RA

By James G. Hollingsworth

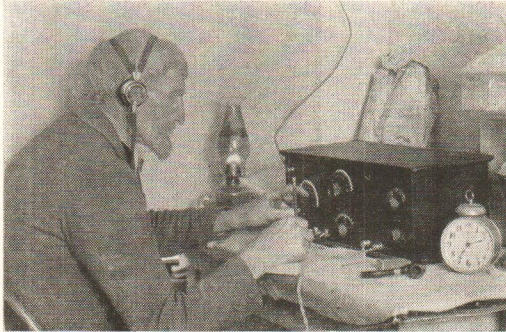

This was Radio in 1922 when people built and repaired their own sets. Anything went—no training was required.

THE Radio man who decides to cast his lot in the Servicing and Merchandising branch of this great industry, goes into a field of manifold opportunity.

Radio Servicing and Merchandising gives him the opportunity to work in his spare time while holding another job. Or, it offers him full time employment working either for himself or one of the thousands of Radio dealers or wholesalers.

Let us consider for a moment the advantages of such a "set-up." Suppose you, for example, are working on a regular job and want to work into Radio Servicing and Merchandising gradually. You can do it in your spare time, in the evenings, while still working the usual hours on your other job. You still draw your usual salary—your Radio earnings are extra profits.

You can use these extra profits to equip a small shop, or you can save them until your spare time Radio business has developed to a point where you have enough business—enough income—to justify giving up your old occupation and giving your whole time to Radio. Under this plan you risk nothing, and stand to gain a fine profitable business of your own.

On the other hand, you may have sufficient capital to sustain you while you are building up a business, and may desire to start full time at once. Or, it may be that you are out of employment at the time, and have nothing to lose by devoting full time to the Radio Servicing and Merchandising business. In these cases you will start out full time at once, and you will be surprised how soon, by the application of your N. R. I. training, your business will be paying you fine dividends.

There is still another method of getting started in the Radio Servicing and Merchan-

dising field. There are those men who prefer to start out working for someone else, planning to either continue working in the organization of some other person, or later branching out into a business of their own. The thousands of Radio dealers and wholesalers represent a profitable market for the services of these men. While the majority of dealers prefer that their servicemen come with them on a full time basis, there are organizations which will take in servicemen part time—permitting them to hold down regular jobs while breaking into the Radio business. Such Radio organizations usually fall into two classes—namely, the small dealer who has not yet built his business to a point where he needs a man full time, or the larger dealer who needs additional help during vacation periods, during holidays, etc.

Let us stop and consider for a moment what is meant by "Radio Servicing and Merchandising." Let us also see who uses men skilled in Radio Servicing and Merchandising.

"Radio Servicing and Merchandising" may be defined as the science and art of repairing, buying, and selling of Radio equipment at a profit.

After the equipment has been manufactured in the Radio factory, it must be sold through distributors. (Or wholesalers or jobbers, as they are sometimes called.) The distributor, in turn, sells them through dealers. The dealer sells them to the public. In each step, from the Radio factory, to the final purchaser, there is need for the expert services of Radio servicemen, and men skilled in merchandising. The factories, the distributors, the dealers, all use trained men who can buy, sell, and service Radio equipment. In addition, there are thousands of organizations, which do *no merchandising* of Radio receivers, merely operating

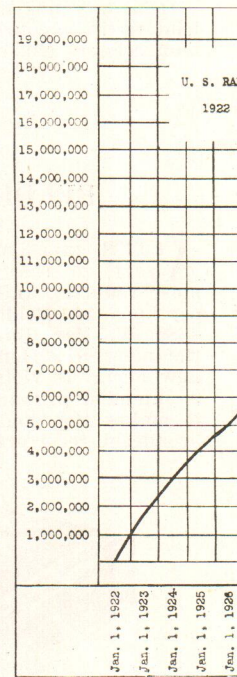

RADIO SERVICING and MERCHANDISING

N. R. I. Vocational Advisor



as *service stations*, which use thousands of Radio servicemen. Add to this the number of independent Radio servicemen, and you have a fairly good picture of the employment possibilities in Radio Servicing and Merchandising.

Under the American system of broadcasting, there always has been, and always will be, a definite relationship between Radio Servicing and Merchandising and the money spent for advertising over the broadcasting stations. This is because Radio Servicing depends, to a great extent, upon the amount that receivers are used. The use of the receivers depends upon the programs broadcast, and the broadcasts themselves are financed by advertising. During the year 1934 there was spent, in this country, \$72,887,169 for broadcast advertising.

Advertisers would not spend such an enormous amount if it did not pay them to do so. The fact that it does pay indicates that they

have listeners. Since the set owners are listening, there is an enormous Radio Servicing market indicated. **THE MORE THEY LISTEN, THE MORE RADIO SERVICE THEY BUY.**

The question is frequently asked, "Isn't the market saturated with Radio receivers—are people buying as many new Radio sets as heretofore?"

To answer that question, let us again turn to statistics. In the United States Census of April, 1930, it was shown that there were 12,048,762 Radios in the United States. This represented a coverage of 40.3% of the homes in the United States (figuring on the basis of 4.1 persons to a family). From the previous Census, to January 1, 1934, a period of three and one-half years, approximately 5,899,400 new Radios had been purchased, representing an increase of 49%, and making the total of homes owning Radios, as of January 1, 1934, 17,948,162—a total percentage of

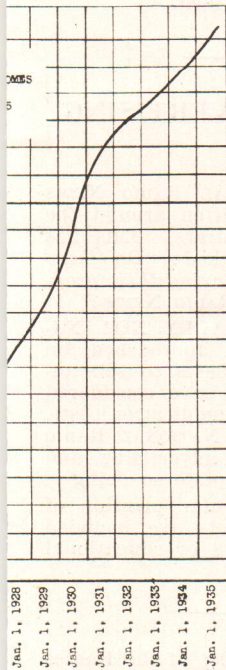

The Radio of today is a thing of beauty—a part of the furnishings of the home. Only the trained Radio man is capable of servicing such sets.

60% of the homes in the United States.

To bring those figures more nearly up-to-date, let us see what happened in 1934. The total number of Radio homes in the United States, as of January, 1935 (the end of 1934), is conservatively estimated to be 19,000,000—or 63.5% of all homes, based on current trade estimates, which place the 1934 set sales at 4,500,000 receivers. Of the total 1934 sets, about 1,000,000 were sold to homes not previously equipped with Radios. So it may be assumed that while 4,500,000 receivers were sold—only 1,000,000 of these were to new homes, the remaining 3,500,000 receivers being used to replace obsolete equipment previously purchased.

The figures given do not include at least 2,000,000 automobile Radios in use, nor do they take into consideration the fact that there are probably 2,000,000 additional Radio sets in these Radio homes, many of which use more than one receiver.

To throw additional light on the demand for the services of skilled Radio men, it is conservatively estimated that there are at all times approximately *three-quarters of a million Radio sets in the United States which are not in operating condition, and need the services of trained Radio men.*

Figure 1, "U. S. Radio Homes 1922-1935," gives a partial picture of the market. Compare the market of 1922 with its million Radio receivers to be serviced, with the market of today with over 19,000,000 Radio homes owning receivers.

Then consider the vast field opened up by automobile Radio sets, 2,000,000 of which are already installed and which present a service market, but which represent a very small coverage of the ultimate field. It is only neces-

(Page 18, please)

Opportunities in Servicing and Merchandising

(Continued from page 17)

sary to consider this 2,000,000 Radio receiving sets in comparison to the number of pleasure cars, busses, etc., which will be eventually equipped with automobile Radio, to get a fair picture of the additional opportunities which will be presented in that branch of the Radio industry. At the present time less than 16%

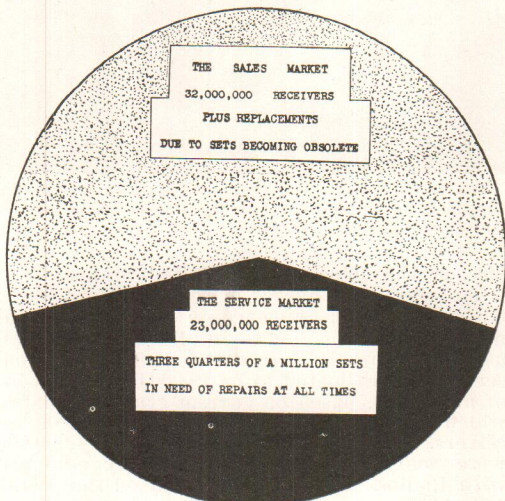

Figure 2

of the Radio set owners also own automobile Radios.

Totalling the home receiver and auto receiver sales market, we find that 36.5%, or approximately 11,000,000 homes, still remain without Radios. It is estimated that 21,000,000 automobiles are still not Radio equipped, giving us a potential sales market of 32,000,000 receivers, plus, of course, the normal yearly replacements of old sets becoming obsolete. This is your sales market.

Now let us look into the total possibilities of the Radio servicing market. Radio receivers are in 19,000,000 homes. There are at least 2,000,000 additional receivers in these homes (homes owning more than one receiver). Add to this 2,000,000 automobile receivers, and you have your service market—23,000,000 receivers. See Figure 2.

There are comparatively few *thoroughly trained and capable* Radio men to care for and take advantage of this market. N. R. I. graduates are *thoroughly trained and capable*. The field is broad—it offers wonderful opportunities. The market awaits you. Take advantage of it.

Page Eighteen

What the National Housing Act Means to You

(Continued from page 4)

Radio, which are not permanent, "built-in" parts of the property.

How then, you will ask, can I, as a Radio man, benefit from this National Housing Act? You can do it in two ways.

First, by contacting those persons in your community who are building or modernizing with such a loan and selling them on the idea of a "built-in" Radio or "built-in" wiring for the receivers. This alone can result in quite a bit of profit for the Radio-Trician who is alert and willing to look for business.

Second, you must take into consideration an extremely human tendency. That is, once the home owner has embarked on the business of fixing up his property, he will use his own funds to a large extent, for such movable items as Radios, and for repairing and putting them in first class shape so that they will be, in appearance and in performance, in keeping with the improved surroundings. Watch those new buildings. Watch those buildings which are undergoing reconstruction and modernization. Get in touch with the owner and sell the idea of a "built-in" job where possible and a complete overhaul of the present receiver where you cannot sell the "built-in" idea.

— n r i —

WE DON'T SELL ADVERTISING SPACE

In the columns of NATIONAL RADIO NEWS frequently appear articles written around the products of certain manufacturers. This has caused the question to be asked: "Do these firms pay for the privilege of having their products advertised in NATIONAL RADIO NEWS?"

The answer is **EMPHATICALLY NO!** NATIONAL RADIO NEWS has been approached, on numerous occasions, with requests to sell advertising space. Frankly, we have considered it, as a means of offsetting the publication costs, which are high. But so far, NATIONAL RADIO NEWS has never accepted paid advertising, and does not, at this time, contemplate so doing.

Articles which make particular mention of various manufacturers' products are included when we think they have news or educational value to our readers.

— n r i —

In the Republic of France 40% of the Radios are of American manufacture.

RADIO-TRICIAN SERVICE SHEET

COMPILED SOLELY FOR STUDENTS & GRADUATES



RCA-VICTOR MODEL 221; GENERAL ELECTRIC M-65; CANADIAN RCA-VICTOR 221

LINE-UP CAPACITOR ADJUSTMENTS

I.F. Adjustments—Two transformers comprising four tuned circuits are used in the intermediate amplifier. These are tuned to 370 K.C. and adjustment screws are accessible as shown in Figure D. Proceed as follows:

(a) Short-circuit antenna and ground terminals and tune receiver so that no signal is heard. Set volume control at maximum and connect a ground to chassis.

(b) Connect oscillator output between first detector control grid and chassis ground. Connect output meter across voice coil of loudspeaker and adjust oscillator so that, with receiver volume control at maximum, a slight deflection is obtained in output meter.

(c) Adjust secondary and primary of first and then the second I. F. transformers until maximum deflection is obtained. Keep oscillator output at low value so that only slight deflection is obtained on output meter at all times. Go over adjustments a second time, as there is a slight interlocking of adjustments. This completes I.F. adjustments.

R.F. and Oscillator Adjustments—R.F. line-up capacitors are located at bottom of coil assemblies instead of their usual position on gang capacitor. They are all accessible from bottom of chassis except the 600 K.C. series capacitor, which is accessible from rear of chassis. Proceed as follows:

(a) Connect output of oscillator to antenna and ground terminals of receiver. Check position of indicator pointer when tuning capacitor plates are fully meshed. It should be coincident with radial line adjacent to dial reading of 540. Then set Oscillator at 1400 K.C., dial indicator at 1400 and oscillator output so that slight deflection will be obtained in output meter when volume control is at maximum.

(b) With Range Switch at "in" position, adjust three trimmers under three R.F. coils, designated as L.W. in Figure D, until maximum deflection is obtained in output meter. Shift Oscillator frequency to 600 K.C. Trimmer capacitor,

accessible from rear of chassis, should now be adjusted for maximum output while rocking main tuning capacitor back and forth through signal. Then repeat 1400 K.C. adjustment.

(c) Now place Range Switch at "out" position, shift Oscillator to 15,000 K.C. and set the dial at 15 on megacycle scale. Adjust three trimmer capacitors designated as S.W. in Figure D for maximum output, beginning with oscillator trimmer. It will be noted that oscillator and first detector trimmers have two positions at which signal will give maximum output. The position which uses lower trimmer capacitance, obtained by turning the screw counter-clockwise, is proper adjustment for oscillator, while position that uses a higher capacitance is correct for detector. Both of these adjustments must be made as indicated irrespective of output. The R.F. is merely peaked. In conjunction with detector adjustment, it is necessary to rock main tuning capacitor back and forth while making adjustment. This completes line-up adjustments.

Important points to remember are need for using the minimum oscillator output to obtain deflection in output meter with volume control at maximum position and manner of obtaining proper high frequency oscillator and detector adjustments.

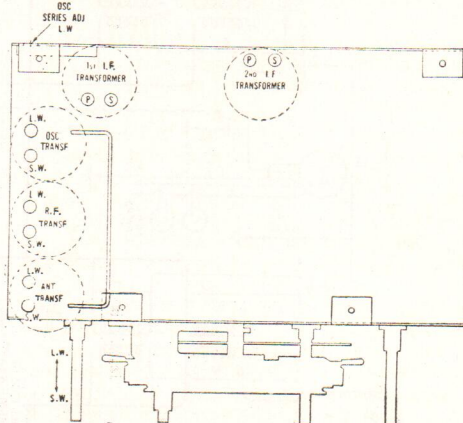

Page Nineteen

Readers who file Service Data in separate binders remove page carefully, trim on dotted line for same size as data published heretofore.

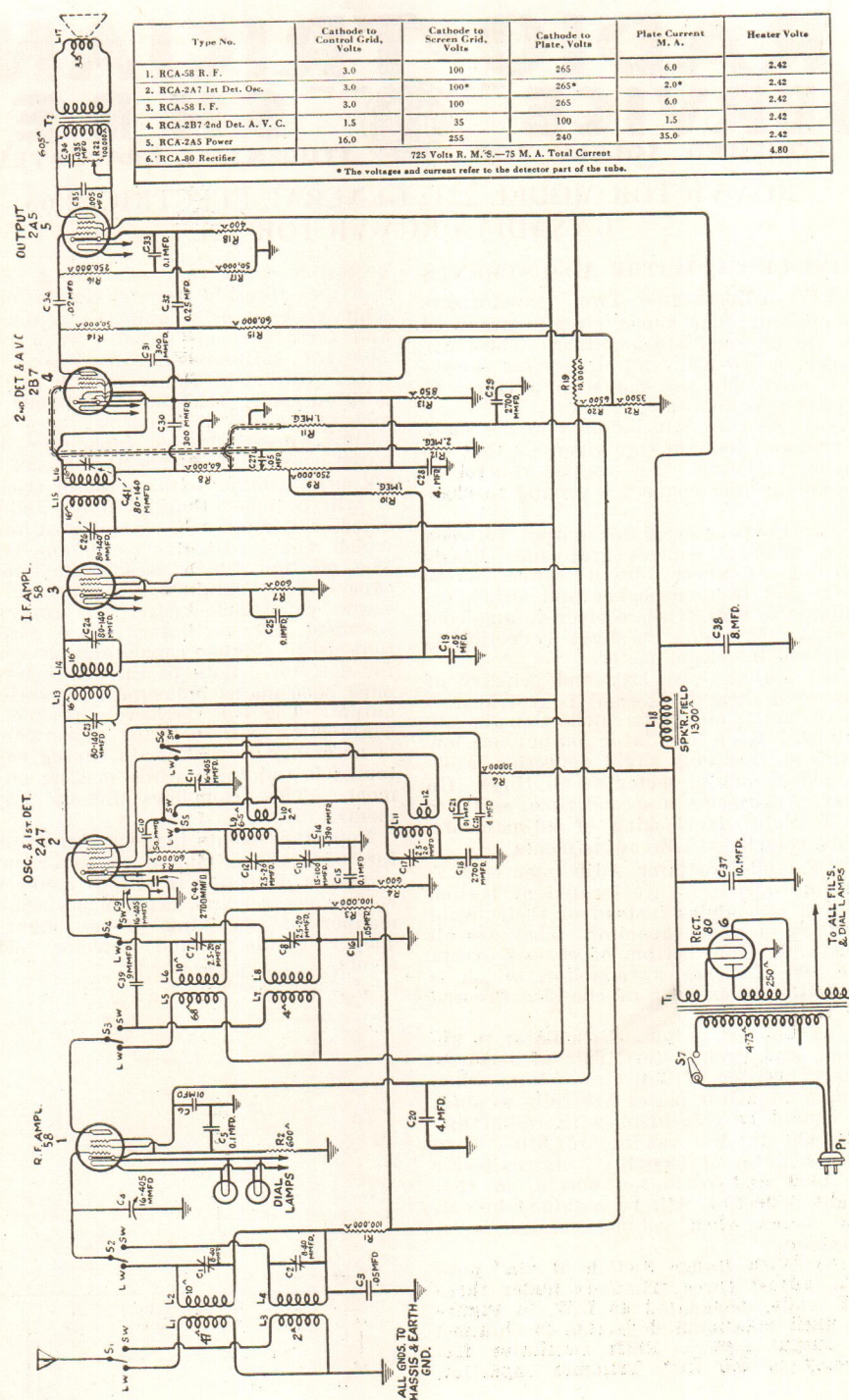

Type No.	Cathode to Control Grid, Volts	Cathode to Screen Grid, Volts	Cathode to Plate, Volts	Plate Current M. A.	Heater Volts
1. RCA-58 R. F.	3.0	100	265	6.0	2.42
2. RCA-2A7 1st Det. Osc.	3.0	100*	265*	2.0*	2.42
3. RCA-58 I. F.	3.0	100	265	6.0	2.42
4. RCA-2B7 2nd Det. A. V. C.	1.5	35	100	1.5	2.42
5. RCA-2A5 Power	16.0	255	240	35.0	2.42
6. RCA-80 Rectifier					4.80

725 Volts R. M. S.—75 M. A. Total Current
* The voltages and current refer to the detector part of the tube.

ing source is used on the 885 gas triode, the horizontal amplifier is not used, but the tube is used as a saturated tube resistance. The frequency is initially adjusted in large steps by several condensers and carefully adjusted with the series variable resistors. Then the control signal is introduced, the amount determined by the input potentiometer.

An 80 rectifier supplies the potentials for the amplifier tubes (the 57's) and the gas triode. Linear sweep voltages from 15 to 15,000 c.p.s. are produced, and there are four ways to operate the sweep plates. When the switch is placed on INT the sweep circuit is guided by the analyzed signal; when placed on 60 c.p.s. it is controlled by the 2.5 volt, 60 c.p.s. source; when placed on EXT it is controlled by an external signal which may be a part of the analyzed signal or some mutual

frequency and phase determination, and its use as a voltmeter and ammeter.

A TYPICAL CATHODE RAY OSCILLOGRAPH

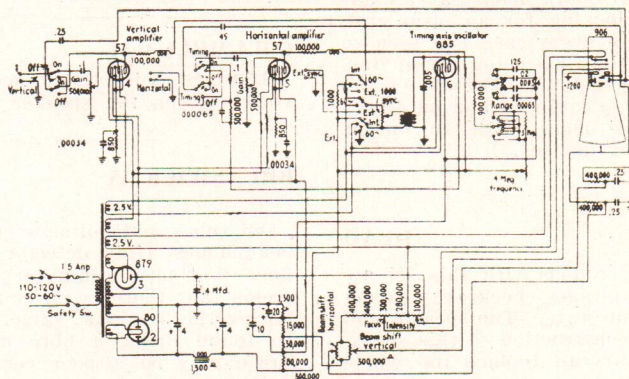

Figure 10a

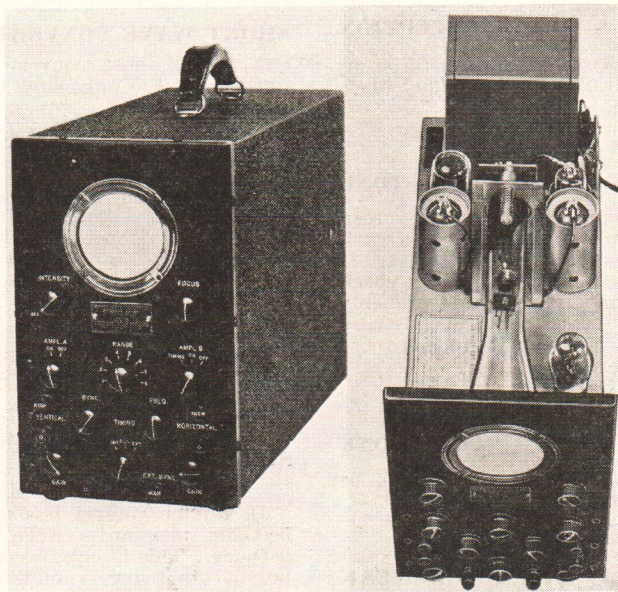

Figure 10b

operating source; and when connected to EXT with no input connection made, the horizontal amplifier is the only circuit feeding the sweep plates. The amplifiers are linear (+ or -10%) from 6 to 90,000 c.p.s. Suitable switching is provided so either the signal with or without amplification may be applied to the deflection plates. The unit is only intended for audio and picture (television) signal analysis and for service use is quite sufficient. R.F. voltages may be analyzed, but they must be connected directly to the deflecting plates, where the signal is weak suitable external R.F. amplifiers must be used.

Looking Ahead

In my next article, part 2, I will describe the use of this instrument for line voltage visualization, frequency and phase determination, and its use as a voltmeter and ammeter.

**SILVER MARSHALL
ALL MODELS**

I have seen several servicemen tear up circuits on these sets, looking for an open grid, or open condenser. In every case I've seen so far, the trouble was the I.F.'s being out of line. The I.F. can be adjusted with the aid of the tuning meter on sets so equipped and on others adjustment should be made with an output meter as an indicating device.

————— *n r i* —————

GEM A.C. & D.C.

DEAD

The most common trouble with this set appears like this. All voltages check okay except plate voltage on output stage. The speaker coil is open. Due to the construction of this speaker, it will be necessary to replace the whole speaker.

————— *n r i* —————

TEMPLE 8-80

WEAK RECEPTION

One of the bias resistors will prove to be off value in the R.F. if all other voltages and tubes check okay.

————— *n r i* —————

TEMPLE 110 SUPER

DEAD—POOR TONE

No screen grid voltage shows. Break screen connection at candohm resistor and use a variable resistance until correct voltage shows. If you have screen voltage on tubes, and all check okay, and still no signals, voice coil is probably open. This speaker must be adjusted very carefully, as there is not enough room to use the smallest of speaker shims on it.

————— *n r i* —————

COLONIAL 32

POOR TONE

The bias resistor of the first A.F. should be checked for this complaint.

————— *n r i* —————

KYLECTRON K-70

DEAD OR WEAK

If voltages and tubes check okay, check .08 mfd. coupling condenser between the first A.F. and the output stage. You can use a .06 or .1 mfd. replacement.

————— *n r i* —————

D.C. TEMPLE

POWER TUBES BURN OUT

This set uses 4 type 71 tubes connected in parallel, the filaments connected in series. Any fluctuation above normal of the line voltage,

Page Twenty-two

and the tubes go west. This may be cured by connecting a 400-ohm "Wire Wound" resistor across the 71A filament circuit.

————— *n r i* —————

COLUMBIA C-31

DEAD

If tubes and voltage check okay, inspect the voice coil on the speaker.

————— *n r i* —————

BRUNSWICK 15

**INTERMITTENT
RECEPTION**

All tubes and voltages check okay. Connect headphones after detector circuit. Set plays fine. For one unfamiliar with this circuit, it seems that there is no coupling condenser following the first A.F. stage. This, however, will be found under a fibre mounting strip. The cause may be a poor connection or the condenser may be bad.

————— *n r i* —————

SHORT WAVE CONVERTERS

WEAK

A lot of these converters were made in a hurry, and the only cure is to resolder all the joints.

————— *n r i* —————

AIRLINE 64

WEAK

Short out the tuning meter and set will be as good as new. Meter is burnt out and should be replaced.

————— *n r i* —————

CLARION 320

**INTERMITTENT
RECEPTION**

Check condenser in the 57 detector-oscillator circuit. Replace with an .0008 mfd. condenser.

————— *n r i* —————

SILVERTONE 110

**POOR CONTROL
OF VOLUME**

If volume control is okay, place a five-watt 500-ohm resistor between volume control and cathode. This is only necessary where it is impossible to reduce volume sufficiently on locals.

————— *n r i* —————

KOLSTER 43

FADING

Check 0.6 mfd. condenser in the screen grid circuit for an intermittent open.

————— *n r i* —————

GULBRANSEN 9

FADING

This trouble is nearly always due to poor connections in the local-distance switch.

FROM SOUTH AFRICA

From the other end of the globe we received a letter which we want you to read. It is from our good friend and N. R. I. graduate, R. J. S. Rose, Chief Engineer of ELECTRON RADIO SERVICES, LTD., Johannesburg, South Africa. Mr. Rose writes:

"As a graduate of your Institution, and one who is well acquainted with the value of N. R. I. Training, I take this liberty of writing you again after some years.

"Owing to the fact that conditions in this country have been improving steadily during the last three years, and that the Radio business is fairly well established, the demand for trained Radio men exceeds the supply and is definitely on the increase.

"I have been associated with the Radio Industry in this country for the past ten years. I have my own Radio business here. I have certainly derived great benefits from my N. R. I. Training."

EDITOR'S NOTE:—It takes graduate Rose one month and nine days to get a letter from his home to N. R. I.

— n r i —

AND FROM ICELAND . . .

. . . we bring you a photograph of the workshop of National Radio Institute graduate S. P. B. Arnar, whose address is P. O. Box 354, Reyjavik, Iceland.

Mr. Arnar has quite a problem on his hands. The Government in his country handles Radio sales as a monopoly and gives 12 months free service. Mr. Arnar, competing with the monopoly, has set up a service station of his own and reports that the number of sets he receives for service is increasing.

Congratulations, Arnar. That is really succeeding under difficulties. NATIONAL RADIO NEWS wishes you the best of luck.



NEW MULTIPLE RADIO INSTALLATION FOR ALL-WAVE RECEIVERS

For the past two years an attempt has been made to provide a suitable antenna system for use in Radio stores and in small apartment houses, as well as homes in which more than one all wave Radio receiver is desired.

Multiple antenna systems for the broadcast band are now more or less common, but they are unsuitable for use in connection with all wave receivers.

The system very thoroughly outlined in the accompanying illustrations has been developed by Arthur H. Lynch, Inc., 227-229 Fulton Street, New York City, and has been put through the acid test of service in some of the largest Radio stores in the New York area. In many cases, where five or six different antennas were employed and where such facilities would not meet the requirements of noise free reception on the short wave bands, it has been found possible to do all the necessary demonstrating with one or two of the new aerials.

A more rigid test of the efficacy of this system can hardly be imagined, than is found in the various stores of the Vim Radio Company, which are located in sections of the city where subway, elevated, street car and automobile traffic is found at its height. Here, these new aerials are rendering suitable demonstration service every day.

In one week the installation of antennas of this nature resulted in the consummation of the sale of three Radio installations valued at \$2400.00 each, which had been unsatisfactory with all other types of aerials.

One very important feature in connection with this system is the fact that regardless of the number of receivers employed, it is but necessary to use one antenna transformer and one receiver transformer.

See diagram on Page 24.

— n r i —

Of quite some interest to Radio men in the Chicago area is the result of a recent survey in which approximately 6,000 residents were asked, "What three things would you like to buy in the order of their importance to you?"

The answers were: (1) a Radio set; (2) an automobile; (3) a rug. The same survey in 1934 placed an automobile first; Radio second; a rug third, while in 1933 the order was (1) automobile; (2) Radio; (3) rug.

So it appears that a Radio has become a very desirable item with lots of Chicago people. Think this over, you sales-minded Chicago Radio-Tricians.

THIS PORTION OF THE SYSTEM MUST BE OUT OF THE NOISE AREA; IT SHOULD BE AS HIGH AND AS FAR AS POSSIBLE FROM ANY OTHER OBJECTS, ESPECIALLY OTHER AERIALS

LYNCH - MULTIPLE ANTENNA -

A.A.K. PAT. 1965535
FOR HOME OR DEMONSTRATION PURPOSES

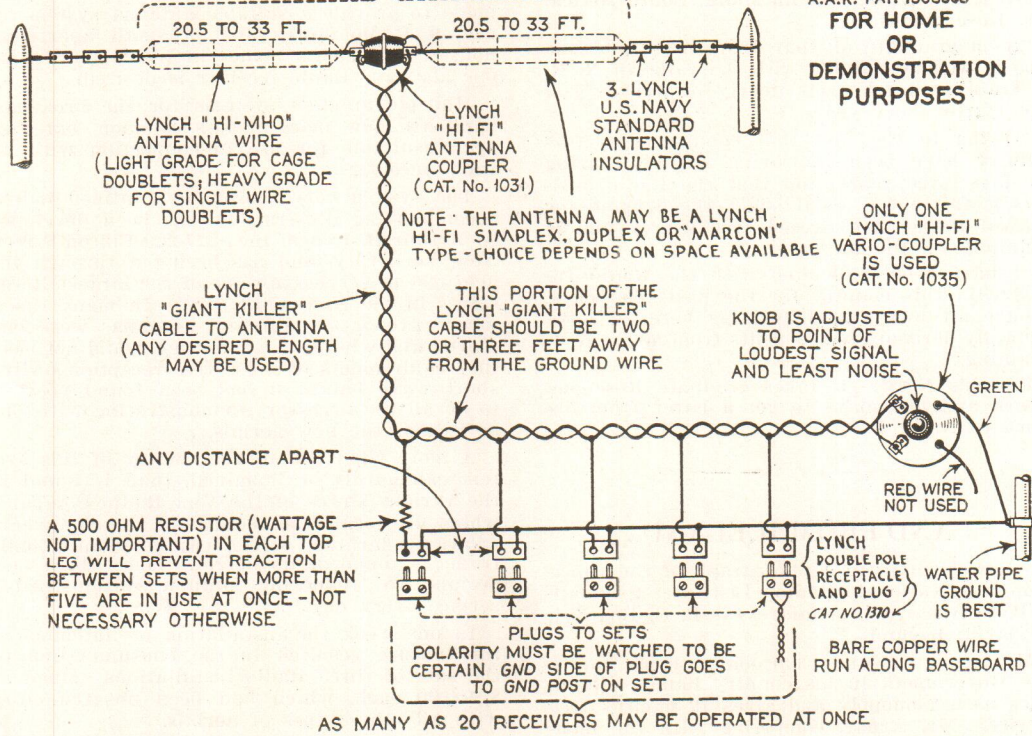

COUPLING CONNECTIONS

With some receivers having a primary input circuit which is not grounded, the regular HI-FI receiver coupler, provided with all Lynch HI-FI kits, may sometimes be used in the manner shown in Fig. 1 with very gratifying results.

The connections for using the Lynch HI-FI Vario-coupler and the Lynch Ham-bands receiver coupler with receivers of conventional design, having antenna and ground binding posts, are shown in Fig. 2 and the method for using either of these couplers in conjunction with receivers having floating primaries, is shown in Fig. 3.

It will be noted that in every instance, the ground portion of the receiver coupler is connected to the ground posts on the receiver and that the use of a ground connection between the GND post on the receiver and a water pipe or similar ground, is determined by the performance of the receiver itself.

Receivers with "floating" primaries are distinguished by the fact that they have two "ANT" binding posts.

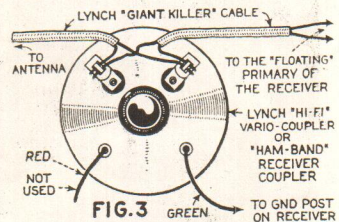
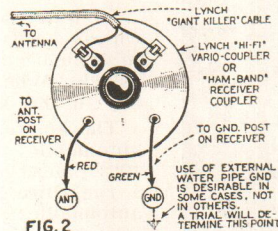
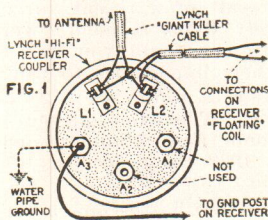

See Article on page 23

Interesting Radio Tube News

A new line of metal Radio tubes has been announced by the General Electric Company. According to reports from their research laboratories at Schenectady, these new metal tubes are not only much smaller and more sturdy, but offer many improved electrical characteristics over conventional tubes. They are particularly advantageous in the field of short wave reception, which in the last year or two has become an important part of all Radio receivers. The short leads of the tubes permit greater amplification at the higher frequencies and the more effective shielding insures greater stability.

These new tubes are not interchangeable with glass tubes in the present type of Radio receivers and will make their first appearance in the new fall line of General Electric sets.

The metal tubes are cylindrical in form, some in reduced diameter at the top. Others, such as Radio frequency amplifier, have a terminal

with the glass tube in Radio frequency portions of a circuit is no longer required with the new tube. The metal envelope itself serves as a shield. And, since closer proximity of shield to elements can be realized, the shielding is more effective. Whereas, in certain types of glass enclosed screen-grid tubes the anode is shielded first by an internal structure, next by a coating on the inside of the glass bulb, and finally, when in use, by an external "can," in the new metal tube all these functions are performed by the shell.

The new tubes have one more base pin than comparable glass tubes, since the metal envelope has become the shield, and provision must therefore be made to ground this envelope. Designers of the tube have even taken into consideration greater ease of inserting it in the socket. In the present conventional glass tube, two of the base pins are of larger diameter than the others, necessitating alignment of these

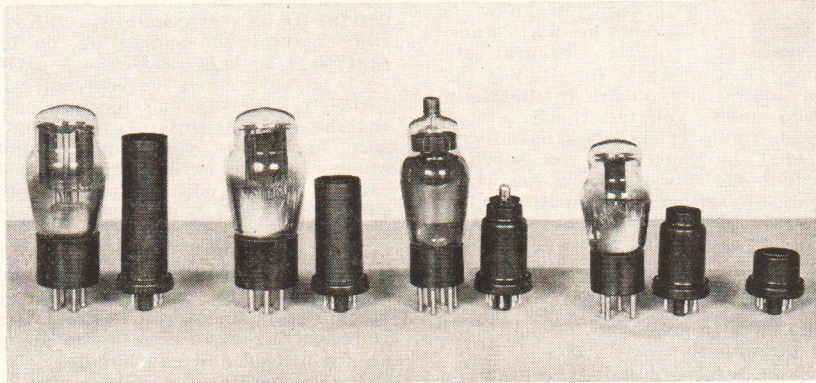

Four glass-enclosed Radio receiver tubes and corresponding metal-enclosed tubes; and on extreme right "Duo-Diode" tube, available only in metal envelope.

at the top extremity. Each lead-in wire passes through a tiny bead of special glass that is fused securely within an alloy eyelet, which in turn is welded to the metal container, thus assuring a long life vacuum. This alloy was developed expressly for the purpose of a perfect seal on the new tubes.

In the main, the new tubes are less than half the size of the familiar glass tube of corresponding rating. The metal shells are, of course, much stronger than glass bulbs, and not subject to breakage, while the use of short, stiff supports in the new tubes result in less mechanical vibration of the internal elements.

The familiar metal shield which is necessary

larger pins with corresponding socket holes. In the base of the new tube, all the pins are of the same diameter, and in the center is a longer insulated keyed pin. By placing this insulated pin in a hole centrally located in the socket, and rotating the tube until the key slips into its groove, the tube is quickly and easily inserted.

The metal construction has been applied both to existing types of glass tubes having indirectly heated cathodes, and to other newly developed tubes. Included in these is a duo-diode, which is only about five-eighths of an inch high above the base, and a hexode, which is an improved pentagrid converter.

N. R. I. ALUMNI News

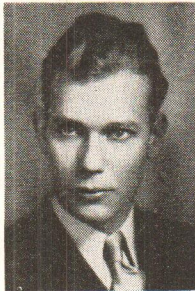

Making the Mails Work For You

By R. B. Murray

Assistant Executive Secretary
N. R. I. Alumni Association

A man may have a fortune in diamonds in his possession, but if he does not let anyone know he has them, he may starve to death. Figuratively, that goes for Radio, too.

People cannot know that you are in the Radio service business unless you tell them.

The successful Radio-Trician is sales-minded. He realizes that he must sell his services. There are various methods of advertising which will accomplish this selling job. In this article I will discuss one plan which has been tested and proved to be valuable—*mail advertising through the use of Government 1c postcards*. This method is economical. It goes by first class mail, and consequently gets attention. It has been found equally profitable in small communities and larger cities.

You can make several hundred contacts a day by the postcard method. This would be a hard job if a serviceman were required to make personal calls—and much more expensive. By the postcard method you can make these contacts for about three or four dollars. Volume counts a lot in building any kind of a business. This plan gives you volume inexpensively.

There are three methods for getting your message on the cards. They can be personally typed, they can be multigraphed, or, they can be printed. Typing, however, is too slow; printing is not sufficiently personal in appearance. Multigraphing, therefore, is the ideal process.

In writing the message—make it as personal as possible. And be sincere. Don't let your message sound like a medicine show poster. Use simple words and short sentences. Write two or three samples, and select the best one for the first card you send out.

Your printer or the multigraph shop will be

Page Twenty-six

glad to cooperate in laying out and printing the cards. Make full use of their facilities. By doing this you will secure the experience and judgment of someone already familiar with advertising.

Wherever it is possible to do so, state in your message that "the card should be kept for future reference if no service is needed at the moment." Or, you may be more definite—and suggest that "the card be placed in the back of the Radio receiver for use when needed." Not so long ago I was talking to a very successful Radio serviceman who informed me that since making the suggestion, on his postcard, *that they be kept in the back of the receiver*, he is getting much better results than he did formerly. He says he receives calls on cards that he sent out three or four months ago. Be sure to include your address and telephone number on the card so that immediate action can be taken, with very little effort on the customer's part, when service is needed on a receiver.

Mail consistently. Send two or three hundred cards a week for the first month. Gradually increase the amount until you have the volume of business you desire. After that, use your mailing according to the amount of business you need and can handle.

A good mailing list is important. Never service a receiver without getting the name and address of the customer. A customer list can be compiled on 3 x 5 inch file cards (you can buy them at any 10c store) and use as a mailing list. Memberships of clubs, lodges, churches, make good mailing lists. You can often get names and addresses from merchants in non-competing lines. Your phone book—even the city directory—are valuable aids in building your mailing list.

The reason the phone book is so valuable is because most persons who have telephone service, also have Radio receivers.

Don't be discouraged if you send out a number of cards and do not get immediate calls. If you follow out the plan as outlined, and work it consistently, however, you will get results. A survey was made shortly before this article was written, which showed that only

(Page 28, please)

Philadelphia-Camden

We have gotten under way with our new Local Chapter paper, which is known as "The Philcam Key." The editor, member Milton Taggart, has received numerous compliments on it, indicating its popularity.

One of the most interesting meetings we have conducted so far was when Mr. John B. Marshall, demonstrated service jobs on a Majestic Model 90 and a Philco 45, both of which were supposed to be *stickers*. Using a new Triplett 1181 Analyzer, Mr. Marshall performed the service jobs on these two receivers, resulting in a great amount of benefit to the members present.

Our members still hold review meetings at which N. R. I. text books are used and a complete review lecture given on them.

Arrangements are pending to have an engineer of the Hygrade Sylvania Corporation address one of our future meetings.

A new membership committee, composed of Messrs. Scott, Marshall, Helmig, Shivers, Reinhart and Leahy, is now functioning at this Chapter.

Just another reminder that all N. R. I. students and graduates are welcome at the meetings of the Philadelphia-Camden Local. For dates of meetings and other information, get in touch with Mr. Clarence Stokes, 2947 Rutledge Street, Philadelphia, Pa.

— n r i —



Fine Cooperation Helps Canadian Chapter

Since Toronto is the only Local Chapter of the N. R. I. Alumni Association in Canada at present, its officers have taken upon themselves the job of serving Alumni members in the entire Dominion of Canada.

This plan apparently meets the approval of Canadian members, as indicated by the cooperation they are giving the Toronto officers.

Jack Lyall is, up to the present time, the long distance champion of the Toronto Chapter. *At each meeting* he makes a round trip of 130 miles, traveling from Port Hope to Toronto. Other members of the Toronto Chapter who frequently make long trips are Jack Fulton, Mitchell, Ont. (250 mile round trip), I. Hartman and E. Bowman, of Kitchener and Waterloo, respectively, make 160 mile round trips, and R. Branscombe, Brampton, who makes a 70 mile round trip.

At a recent meeting, Toronto had the plea-
(Page 29, please)

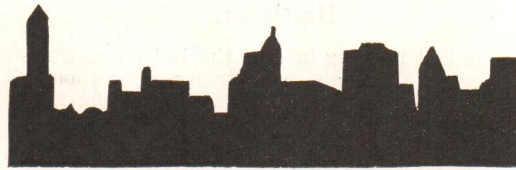

New York Metropolitan Area Chapter

National Headquarters has been cooperating very closely with the New York Metropolitan Area Chapter in recent months. We have had the pleasure of a visit from President J. E. Smith of the National Radio Institute at one meeting, and our Executive Secretary, P. J. Murray, of Washington, has been with us on two occasions. Mr. Smith spoke on the subject of "Organized Efforts," and Mr. Murray on one trip discussed "Salesmanship for Servicemen," and his topic on the other occasion was "Growing Pains."

Mr. Hubert L. Shortt, Chief Engineer of the Wholesale Radio Service Company, gave us an interesting lecture on "Public Address Systems," and Mr. Paul McGee, long prominent in Radio service organizations, spoke on the value of "Organization for Servicemen."

Our members recently turned out in a big body to see Mr. M. F. Paret, Service Engineer of the National Union Radio Corporation, demonstrate the "Cathode Ray Oscillograph."

We can't understand why Phil Murray's *little black book* was not in evidence at the last meeting—but well then, Phil was sick anyhow. The boys certainly did turn out to meet President Smith. There were fellows to present we had never seen before. Christiansen didn't get away with his *fast one* when he selected his own number to win the door prize. Weber won it. Our members think our Service Forum can't be beat. More power to Joe Holub, who conducts it.

Don't forget, New York Metropolitan Area Chapter meetings are held the third Thursday in every month, Hotel New Yorker, New York City. N. R. I. graduates and *students* welcome.

The first issue of our paper, "The Chapter Tattler," has been published. Everybody thinks it's swell.

FLASH

James Kearns, Chairman of the N. R. I. Alumni Association, New York Metropolitan Area Chapter, announces that he has resigned from the Board of Trustees of the Institute of Radio Servicemen, which will enable him to devote more of his time to furthering the aims of the N. R. I. Alumni Association.

Page Twenty-seven

Baltimore

The last meeting held at the Baltimore Chapter before this issue went to press, was one of the most interesting held there in a long time.

Realizing the importance of the meeting, the Baltimore Chapter officers invited the members of The Maryland Radio Association to be their guests. Well in excess of 100 persons attended.

The guest of honor was The Honorable Howard W. Jackson, Mayor of Baltimore, and the principal speaker of the meeting was none other than our friend John F. Rider, Publisher of Radio Service Manuals, who came all the way from New York to address the gathering.

In attendance on this occasion was quite a group from Washington, including J. E. Smith, E. R. Haas, J. A. Dowie, E. L. Degener, Paul Thomsen, George Rohrich, David Smith, and Frank Cook from the National Radio Institute; P. J. Murray and R. B. Murray from National Headquarters of the N. R. I. Alumni Association; F. L. Sprayberry of the Sprayberry School, and Radio dealers of Baltimore too numerous to mention.

Pete Dunn and his "Watch Us Grow" Baltimoreans are really putting on the shows for their Chapter. And do the boys like it!

— n r i —

Making the Mails Work

(Continued from page 26)

two people out of each fifteen who were interviewed had ever received a letter or a postcard from Radio service companies soliciting their business. That is something to think about.

Radio is a real, live, open field for any man who wants to make a good living. Right now, *in your community*, someone is wondering whom to call for Radio service. Make it your business to reach these people so they will know that YOU are the serviceman to call.

As I have stated before, this plan of advertising is inexpensive. With a very limited budget—as low as \$10 or \$15, you can start off on this advertising program. The more carefully you plan it—the better returns you will get. You can enjoy the same success with it as other wide-awake Radio-Tricians who have successfully applied it in their own communities, all over the United States.

In future issues of NATIONAL RADIO NEWS, I intend to discuss other methods of advertising and securing Radio service business. I hope you will be looking for them.

— n r i —

Al Arndt, of New York, must be on the second book of his public speaking course. He did pretty good in Philadelphia.

Page Twenty-eight

Detroit Chapter

Ever since the beginning of 1935, the Detroit Chapter has been enjoying increasing success, both in the number of members turning out to meetings, and the number of new members joining the Chapter.

Part of this, we believe, is due to the fact that arrangements have been made for a more centrally located meeting place, and there is no doubt that some of this increased activity may be traced to the improvements in Radio conditions in general in the Detroit area.

Interesting lectures have been given our members in a number of cases by Mr. Roy Davis, Mr. P. C. Barlow, Mr. A. R. Kreuzer, Mr. Leslie Anderson, on such subjects as laboratory tests, automobile Radio, tube testers, and the cathode ray oscillograph.

Our plan for having our own members prepare talks on interesting subjects for each meeting is working out to the definite advantage of all concerned. In the first place, it gives the members selected for the talk wonderful experience in gathering data on certain subjects. It gives the other members the opportunity of hearing these lectures, which are very beneficial, but what we believe is the greatest advantage, it teaches our members self-confidence and gives them invaluable public speaking experience.

— n r i —

Pilots Select Smooth Air Lanes By Radio

When an air stewardess informs passengers who board a United Air Lines plane for a regular trip that they will have a "smooth flight," she isn't just guessing.

Pilots are now instructed to report by radio telephone air conditions at the elevations at which they are flying. This is in addition to usual weather and position reports. With as many as twenty United planes in flight over the New York-Pacific Coast airway at one time, airports served by United have a complete record of air conditions at different altitudes.

— n r i —

Alumni members! Have you joined your nearest Local Chapter?

— n r i —

Our old friend F. A. Parkins, re-elected Vice-President of the N. R. I. Alumni Association, and a real booster. Frank is Chief Engineer of Radio Station WJTL, at Oglethorpe University, Ga.



Pittsburgh Chapter

Our last meeting was held in our Bellevue branch office, which, as we have told NATIONAL RADIO NEWS readers before, is one of the two we maintain in Pittsburgh. Despite the fact that the weather was very bad, we had a satisfactory attendance and had the pleasure of accepting one new member, Mr. Charles F. Wilson, an N. R. I. graduate of 1928.

At this meeting Mr. Joseph O'Shea, who has been doing such good work for the Pittsburgh Chapter, though not an N. R. I. man, was made an Honorary Member of the Pittsburgh Local, to serve as "Technical Advisor" to the entire membership.

A series of illustrated lectures will be resumed at our next regular meeting, which series will last throughout the entire year. The subjects, all bearing on Radio, will be many and varied.

Pittsburgh Chapter members are 5 meter transmission bugs, and nearly all of our members are going up for Amateur Licenses before very long. We intend to blanket the Pittsburgh area with N. R. I. 5 meter stations. At least seven of our members will be ready for tickets in the near future—so you can imagine that the code practice machines at our various offices about Pittsburgh are running red hot.

— n r i —

Swinging doors between kitchen and dining room of the Hotel New Yorker in New York City are opened automatically by photo-electric tubes. Waiters passing through the light source actuate the relays which operate these doors.

— n r i —

In the Pennsylvania Railroad Station in New York City doors between the waiting room and the train shed are opened and closed automatically by photo-electric cells.

— n r i —

Lightning could do untold damage to the transmitting equipment of Cincinnati's powerful Radio station WLW, were it not for its lightning arrestors actuated by photo-electric cells. This installation diverts extraneous electrical charges and protects the station from the hazard of lightning.

— n r i —



Alumni member Edward J. Meyer, of St. Louis. An up and coming Radio Serviceman—Mr. Meyer will eventually be a big factor in the St. Louis Local Chapter organization of our Association.

Chicago Chapter

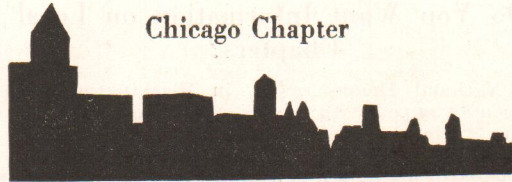

Things have pepped up quite a bit at the Chicago Chapter since Mr. Murray's recent visit. Things are flying fast and furious. Local Chapter membership has grown by leaps and bounds. Due to obtaining a reduction of rates, we will continue to hold our meetings in the Sherman Hotel for the present, this being the spot our boys like.

At our last meeting, in addition to hearing a wonderful talk on Radio tubes (which, by the way, will be continued at a future meeting), we held our annual election of Local Chapter officers.

We also held a "get acquainted" meeting. All members wore their names on their lapels, and before we left, everyone knew everyone else. The meeting was held in a private room of a tavern, with plenty of refreshments for everyone. Much credit is due Mr. Sorg, who served as our entertainment committee, for putting this affair across.

Somebody in this Chapter is going to get an All-Wave Oscillator, shortly, and it isn't going to cost him anything.

Our new Local Chapter publication, "Chicago Chapter's Chatter," is off the press and will be delivered to members in this area shortly after this message is written.

N. R. I. students and graduates in this territory should attend the meetings of the Chicago Chapter. If you don't know the details, get in touch with Chairman E. R. Bennett, 931 Wesley Avenue, Evanston, Illinois.

— n r i —

Toronto

(Continued from page 27)

sure of welcoming student S. G. Pellegrin, who is in Toronto for several months, and has become a regular member. His home is in Cadamin, Alberta, Canada.

The membership committee at Toronto has divided the city into sections, with men working in each section to bring in new members.

Maybe the next time friend Brechin draws No. 13, he won't think it is unlucky. At a recent meeting, he got No. 13 for the door prize, but being a little superstitious, swapped numbers with Bob Makioku. No. 13 won, and Makioku carried off the prize—a set of Hex. socket wrenches.

Here's a new Toronto idea that some other Chapters may want to adopt. Our librarian, Ed. Solman, is doing a land office business as

Do You Want Information on Local Chapters?

National Headquarters, in Washington, has been swamped with requests for information on the various Chapters. "Can I join?" "Who shall I get in touch with?" "Where are they located?" are just a few of the questions asked.

The fine meetings being held and the valuable assistance given to the members are the reasons for this sudden popularity of Chapters of the N.R.I. Alumni Association.

To settle, once and for all, a question which is still in the minds of many, all graduates of N. R. I. who are members of the National Radio Institute Alumni Association are eligible for regular membership in any Local Chapter.

All N. R. I. students who are in good standing at N. R. I. are eligible for Associate membership at the Chapters until such time as they graduate, when they become eligible for Regular membership. N. R. I. students cannot, however, become members of the National Association until they are graduated.

Any students or Alumni members desiring further information regarding Local Chapter activities may obtain it by writing to the Chapters direct, addressing their letters according to the following list:

Baltimore—George Ruehl, Secretary, Charleston and Second Avenues, Lansdowne, Md.
Philadelphia—Clarence Stokes, Secretary, 2947 Rutledge St., Philadelphia, Pa.
New York—Allen Arndt, Membership Secretary, 68 Suffolk, New York City.
Buffalo—T. J. Telaak, Chairman, 657 Broadway, Buffalo, N. Y.
Toronto—Ed. Witherstone, Secretary, 363 Nairn Ave., Toronto, Ont., Canada.
Cleveland—Charles Jesse, Chairman, 3369 West 129th St., Cleveland, Ohio.
Chicago—Samuel Juricek, Secretary, 4223 North Oakley Ave., Chicago, Ill.
Pittsburgh—Albert Maas, Secretary, 9 S. Howard Ave., Bellevue, Pa.
Detroit—William R. Sewell, Secretary, 16039 Curwood St., Detroit, Mich.

Thanks to Lester Kershaw of the New York Metropolitan Area Chapter for this suggestion.
—Editor.

— n r i —

Toronto

(Continued from page 29)

a result. For a 50c yearly fee, library members will be guaranteed the privilege of reading RADIO NEWS, Radio Craft, Short Wave Radio and QST, for the entire year. Of course, we have many other technical books in our library.

Our Local Chapter paper, "The Canadian Radio-Trician," will be off the press in a short time.

Page Thirty

Canadians

Here are a few Service Notes which were sent in by H. C. Dyer, of Preston, Ontario, Canada. He hopes they will be of value to some of our Canadian readers:

GE Model 63—Intermittent.

The variable control arm, instead of being connected to the usual center lug of the volume control, is connected to the back of the container center insulation by a small eyelet rivet, and becomes loose, a drop of solder will do the trick.

Philco 70—Intermittent.

The .01 MFD condenser directly behind the RF choke becomes internally intermittent, and can sometimes be found by gently straining the connecting lugs with an insulated probe with set in operation. With this set it is also worth while to try around the speaker pole piece with a spacing feeler for a true center, as the spillover center is a tight fit over a small extension the trueness depends on exactness of machining. By removing the centering screw and cutting the fibre around the extension with a very sharp pointed knife a better cone swing can be had, also a better production of the lower tones.

Westinghouse Model 63—Lack of Volume.

The shielded lead connected to the volume control will bear attention. The rough ends of the shield wire may have punctured the insulation of the lead wire.

Westinghouse Model 90 A Intermittent—

No control of volume

One of the outside connecting lugs of the volume control is loose.

Be sure to watch out for the special Canadian Cross Reference Data Sheet, which will appear in the next issue of NATIONAL RADIO NEWS. It has been especially prepared in conjunction with Canadian Westinghouse, for the benefit of our Canadian readers.

— n r i —

The Price of Success

Now if you will take all the fates have to give, Stand hardships and setbacks, still glad that you live;

If you cling to your faith and keep plodding along

When disaster besets you and everything's wrong;

If you're willing to battle and never give in, Go after your dream, for in time you will win.

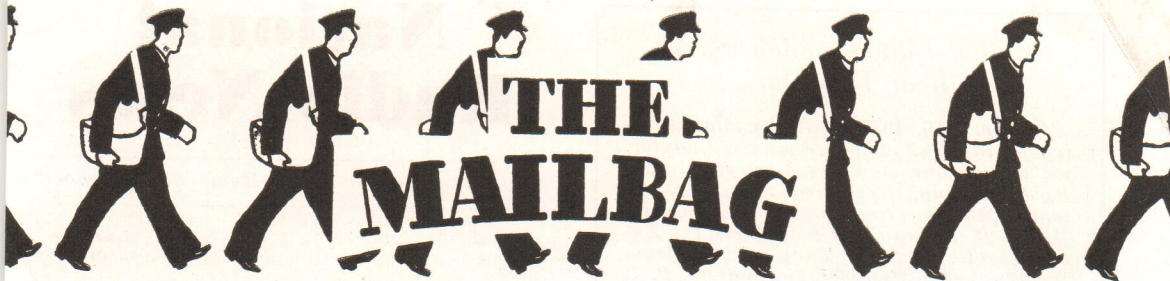

Handy Tool

It is a well-known fact that a small probing mirror, such as dentists use, is a very handy tool around a serviceman's shop. Such a tool would be rather expensive, and I have found a way of making them at practically no cost,

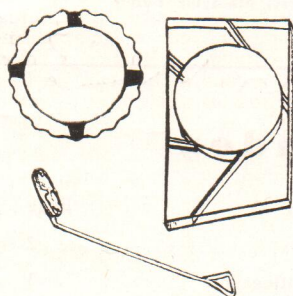

in about fifteen minutes. Furthermore, the home-made mirror suits my purpose better than the regular dentists' mirror.

All the material I need is an old beer bottle cap, a small piece of broken mirror, and about 8 inches of bus wire. First I remove the cork center from the

beer bottle cap. Then I trim off the corrugated edges in such a way as to leave four small tabs projecting from the metal in the center. (See pencil drawing upper left.)

In the upper right pencil drawing is shown my method for cutting a circular piece out of a broken mirror. After this is done, the edges may be smoothed down on an emery wheel. The mirror is then placed face upwards on the beer bottle top and the tabs bent over the mirror in such a way as to hold the two parts securely together.

There only remains to solder the bus wire on the back, as a handle. And the job is done. The biggest advantage of the home-made mirror over the ones which could be purchased ready-made, is that the home-made job has a flexible handle, which is a great help.

WILLIAM B. LAWTON,
Hilton, New York.

— n r i —

Say, NATIONAL RADIO NEWS can't be beat now—it sure is great in all ways.

WESLEY NOE, Lansing, Mich.

\$600—4 MONTHS—SPARE TIME

I wish I had time to tell you all about the success I have had in spare time Radio repairing. I have made about \$600 in the last four months, and have a pretty well-equipped shop, and I am going into full-time servicing in a few months.

ISAAC BAILEY, Monroe, La.
N. R. I. HAMS

H. H. Garriott, W6EMH, Calpine, Calif.
E. M. Carver, Jr., W1IEL, Bridgewater, Mass.
Wm. Findley, W3FEA, Parkersburg, Pa.

— n r i —

In servicing Airline receivers, model 29X, Commander and Cavalier, for a roaring noise, watch the tubular resistors. They have metal bands around them for terminals which become loose, and a poor connection results.

H. V. LAURIAN, Kalamazoo, Mich.

I just received the Feb.-Mar. issue of NATIONAL RADIO NEWS. It is the best magazine of its kind being published today. Congratulations!

J. F. CONNORS, Raritan, N. J.

ATTENTION KNOXVILLE READERS

I have had stolen from me, one model 85 Supreme Tester, serial number HJ1022. I know the person who got it was from the vicinity of Knoxville, Tenn. If you run across it, please notify me. Your name will not be mentioned, and I'll pay a reward for your assistance in this matter.

BERNARD VALOUR,
Box 233, Sloatsburg, N. Y.

Do you have trouble with All-Wave sets using shadow or meter tuning, which refuse to show a change on weak signals? Insert a small resistor (200 to 500 ohms) across the meter and watch the improvement.

L. L. BROWN, Springfield, Mass.

Page Thirty-one

National Radio News

"from the Pioneer Radio Home Study School"

Vol. 6
No. 8

June-July
1935

Published every other month in the interest of the students
and Alumni Association of the

NATIONAL RADIO INSTITUTE
Washington, D. C.

The Official Organ of the N. R. I. Alumni Association
Editorial and Business Office, 16th & You Sts., N. W.,
Washington, D. C.

P. J. Murray, Managing Editor

Philadelphia-Camden Says: "Beat This One"

On April 16, 1935, at the regular meeting of the Philadelphia-Camden Chapter, we offered our members a surprise. Mr. P. J. Murray, Executive Secretary, attended the meeting, bringing with him Mr. R. B. Murray, the new Assistant Executive Secretary. They drove from Washington to Philadelphia and Mr. P. J. Dunn, National President of the N. R. I. Alumni Association, joined them in Baltimore.

Having these three gentlemen was indeed a treat for the Philadelphia-Camden boys, but an added surprise was in store. The meeting had scarcely gotten under way when another car pulled up in front of the meeting hall containing Mr. J. L. Kearns, Chairman of the New York-Metropolitan Area Chapter and his Executive Committee consisting of Mr. Allen Arndt, Mr. Joseph Holub, and Mr. Otto Struble.

Philadelphia-Camden claims that this is a record—and wants to know if any other Chapter has been able to beat it.

Triplett Tube-prong Adapter

Oliver J. Ruth, 5511 Park Heights Avenue, Baltimore, Md., member of the Baltimore Chapter, sends us this sketch. He says he's found it mighty handy, especially with very compact receivers.

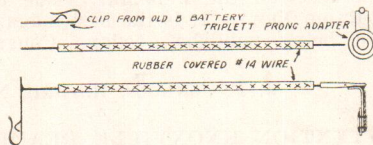

— n r i —

In Wallach Bros. Store, Fifth Avenue, New York, illumination is kept constant by photoelectric tubes. Regardless of fluctuations in daylight, the interior of the store is always well lighted. These tubes automatically function to turn off and on enough lamps so that a constant degree of illumination is maintained.

— n r i —

Jim Kearns, of the New York-Metropolitan Area Chapter of the Alumni Association, wants to know where a fellow can buy tires for a Buick at two o'clock in the morning in Philadelphia.

Page Thirty-two

Index

Article	Page
Shadow Boxing	2
Cathode Ray Oscillograph	3
Putting Your House in Order	4
The National Housing Act	4
Easy Measurement Charts	5
Service Forum	7
All-Wave Radio in 2000 Rooms	12
Data Sheets	13-14
Running Around in Circles	15
Opportunities in Radio Servicing and Merchandising	16-17
Data Sheets	19-20
Multiple Radio Installation for All-Wave Receivers	23-24
New Radio Tubes	25
Alumni News	26-27-28-29-30-32
Mailbag	31