

Radio Digest

WEEKLY Illustrated 10¢

LEE-KING DRUG CO.
NEW YORK

Vol. 1 Copyright, 1922, E. C. Rayner CHICAGO, ILL., SATURDAY, JULY 1, 1922 No. 12

GIVES BROADCASTS PEP

STATE BROADCAST PLAN OF YANKEES

MASSACHUSETTS INVESTIGATES PUBLIC RADIO

Reliable Source of Information Goal Sought by Author of Bill Before Special Committee

(Special to RADIO DIGEST)

BOSTON, MASS.—A plan is under consideration by the Massachusetts state legislature for the establishment of a state owned radio station, and an order for the appointment of a special recess committee to investigate the matter is now before both branches. The specific matters on which this committee would report are: "To install within the commonwealth radio broadcasting stations for the use of the public free of charge.

"To suggest methods for the purpose of governing or regulating the transmission of messages where State laws are required.

"To propose a method of public distribution of radio receiving equipments to be used by the people under a system of public ownership."

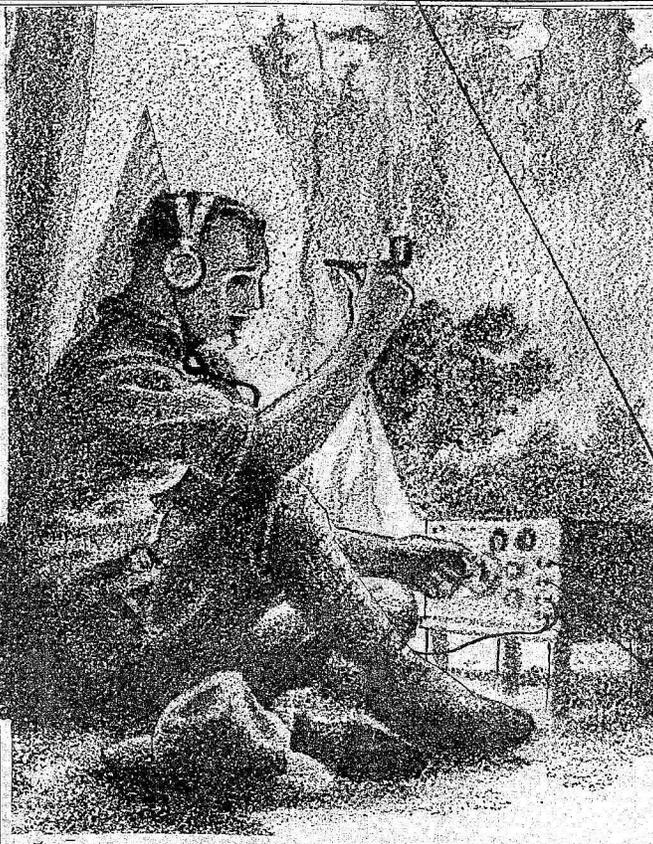

MUSIC LOUD WHEN USING SELF TUNER

Dr. R. S. Piper of Chicago Designs New Coupling and Tuning Transformer

Reception Much Improved

Basic Principle to Obtain Perfect Resonance—Perfect Coupling Automatically Assured

(Special to RADIO DIGEST)

CHICAGO.—A discovery so simple that it seems hardly plausible has enabled Dr. R. S. Piper of this city to predict that the

PLAN TO RADIOPHONE POLITICIANS' ORATORY

Two Weeks Before Election Desired for Radio Speeches

WASHINGTON.—Candidates for Congress will be permitted to broadcast their political speeches by radio for two weeks just prior to the election, if plans of the American Radio Association, with national headquarters here, materialize.

Several prominent politicians have voiced their objections to the use of their government radio for political purposes, with the result that it was recently discontinued.

KANSAS PLANS SHOW DURING SEPTEMBER

LINDSBORG, KANSAS.—The Kansas Radio League will hold a convention some time during September. It is expected that many manufacturers from the east will be there with exhibits. The state probably will stand a good share of the expense. The show will be held in the Convention Hall. Prof. R. F. Miller is the president. W. L. Harrison, vice pres.

NORMANDY CHIMES LOCATED BY RADIO

Salt Lake City Fan Hears Call for Missing Stage Property

SALT LAKE CITY.—A unique mission was given to KZLN, the Desert News Radio station, recently when Ray Brandon, company manager of the Wilkes theatre, found themselves in a quandary with reference to the production of "The Chimes of Normandy."

One of the exacting requirements of "The Chimes of Normandy" is a set of cathedral chimes. The company finding itself without this necessary property, a search was made of the local music stores, but without success.

It was then that KZLN was utilized as a means of securing the important item. The company's appeal for aid was broadcast by The News station and within a short time a local Radio fan having a set of bells responded.

Cincinnati Holds First National Radio Holiday

WLW Furnishes Program for Event at Chester Park

CINCINNATI, OHIO.—Saturday, June 10, was Radio Day in Cincinnati, and thousands of persons participated in the celebration, which was conducted at Chester Park, a summer resort, and which was under the auspices of the Crosley Manufacturing Company, operators of the broadcasting station WLW. Wide publicity, both in the air and in the newspapers, had been given to the event, and from noon until late in the evening the park was filled with Radio enthusiasts. From 2 p. m. until late in the evening there was a wireless concert, which was broadcast by WLW, and was so amplified at the park that everyone on the grounds was able to hear the music. This is believed to have been the first Radio Day in the United States.

day of the crystal detector is not yet over and to open the way to an even more satisfactory usage of the vacuum tube for Radio reception than is today the case. Dr. Piper has invented a supplementary tuning and coupling transformer of a radical design, departing as it does from the conventional types of loose couplers, vario-couplers and tuners now in use and on the market. The transformer is unique in its basic principle in that it accomplishes its own coupling adjustment automatically.

(Continued on page 2)

RADIO CONTROL FOR ELEPHANTS LATEST

NEW YORK.—George Power, animal trainer of the New York Hippodrome, recently put his elephants through their regular performance by transmitting his orders to them via radio from a point distant from the stage. Each of the animals was fitted with a pair of head receivers, about the size of soap plates, connected with a long, flexible wire.

GIVES BROADCASTS PEP

(Continued from page 1)

When inserted in the antenna and secondary circuits in place of the conventional coupler, the supplementary tuning and coupling transformer brings in signals with an audibility of probably ten times as great as the average.

Resonance Brings Results

The new device was invented by Dr. Piper after a careful study of the subject of resonance. In this study he decided that to obtain the maximum results from the feeble oscillations impressed on the aerial, it would be necessary to have the primary and secondary not only tuned to the incoming wavelength at all times, but that the coupling must be perfect in order to insure resonance.

The perfect coupling could only be assured by a design such as would permit the received signals to find their own degree of tight or loose coupling. This is obtained in the new transformer by incorporating all degrees of tight and loose coupling between the maximum and minimum. Thus by insuring the proper coupling, perfect resonance to the received signals is attained, and the greatest possible amount of energy is taken from the oscillations impressed on the aerial.

Advantages Claimed

The average receiving transformer having a variable coupling must be first tuned in the primary circuit to the wavelength of the desired signals, then tuned in the secondary. After tuning both circuits, the coupling adjustment is made. Due to the usual capacity effect of the secondary and primary, the change in the adjustment of the coupling throws off the values of the two inductances, making it necessary to again tune the two.

Dr. Piper claims that it is practically impossible to obtain maximum resonance under these conditions, and that the only way to avoid this difficulty is by some device such as his, in which perfect coupling is obtained without a mechanical adjustment. He has already made application for a patent covering his invention.

In a demonstration, the signals of KW, Chicago, were received with the audibility of the average two step amplifier receiver, despite the fact that the apparatus was in an office building, surrounded by all kinds of steel obstructions.

"RADIO SEARCHLIGHT" INVENTED BY MARCONI

Device Directs Beam of Ether Waves Where Wanted

(Special to RADIO DIGEST)

NEW YORK.—Guglielmo Marconi has a new invention which will rid the sea of some of its terrors. The famous inventor terms it a "Radio Searchlight." The Radio wave can be reflected like light waves in a beam in a given direction instead of broadcast. If this invention is used with a revolving reflector it will constitute a Radio Light House, Marconi says. "By means of the revolving beam of electrical radiation it is possible for ships when within a certain distance to ascertain in thick weather the bearing and position of the lighthouse.

"It seems to me that it should be possible to design apparatus by means of which a ship could direct or project a divergent beam of the short wave rays in any desired direction, which rays, if coming across a metallic object, such as another steamer, would be reflected back to a receiver on the sending ship and thereby immediately reveal the presence and bearing of the other ship in fog or thick weather."

Standard Oil Tankers Utilize Radio Compass

Government Stations Useful to Merchant Ships on Coast

(Special to RADIO DIGEST)

The fleets of the Standard Oil Tankers have been ordered to make use of the Naval Radio Compass stations to secure or verify their positions off the coasts, which indicates the great value these Radio stations have become to merchant ships. The Standard Oil Company has directed all its "skippers" to make "full and frequent use of the Naval Radio Stations in determining their correct positions." In the event of running aground, the orders state that an investigation will be conducted to ascertain whether or not the vessel used the facilities.

Reports filed in the Naval Communications Service Office, show that in January 11,650 compass bearings were furnished 5,198 vessels; in February, 9,792 bearings were Radioed to 4,759 ships; and in March, 10,215 were reported to 3,897 ships, within an average time of 3.75 minutes; a total of 8,428 bearings being given. Of the last, 7,124 bearings were furnished to merchant ships, and 8 to aircraft, which are coming to use the service as well as ships of the sea.

Armstrong's New Super-Regenerative Circuit Proves Powerful Amplifier

Famous Inventor Shows Possibilities Before Institute of Radio Engineers—Amplifies Signals 50,000,000 Times—One Tube Does Work of Three

(Special to RADIO DIGEST)

NEW YORK.—Major Edwin H. Armstrong, inventor of the well-known regenerative circuit bearing his name, recently demonstrated a new super-regenerative circuit, claimed to amplify received signals 50,000,000 times, before the Institute of Radio Engineers here. The next most powerful amplifier is limited to 5,000 times.

"A short way to describe the super-regenerative circuit," says Major Armstrong, "is that one vacuum tube is made to do the work formerly done by three. It has been shown for several years that the limit of amplification is reached when the

have demonstrated, and enables me to eliminate two tubes from the circuit.

"Makes Short Wave Lengths Available" "Another practical result of this circuit" says Major Armstrong, will be the ability to detect wave lengths under 200 meters with ordinary amateur sets. In the past short wave lengths were indistinguishable for small sets. Now that the range under 200 meters is available for the broadcasting stations, the cost of operating will be lessened. To illustrate the difference between a receiving set equipped with the super-regenerative circuit and the ordinary set, I have found that the signal which can just be heard with a simple regenerative circuit at the most critical

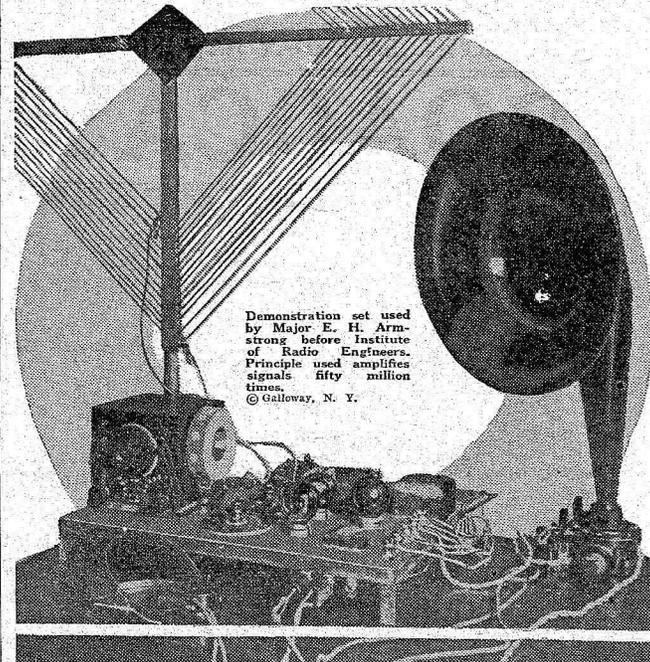

Demonstration set used by Major E. H. Armstrong before Institute of Radio Engineers. Principle used amplifies signals fifty million times. © Galloway, N. Y.

negative charge in the tube approaches the positive. In experimenting I found that it was possible to increase the negative charge temporarily, for about one 20,000th of a second, far above the positive, and still keep the average down. It is the possibility of current which permits the enormous amplification which I

zero point can be heard all over the room with the super-regenerative circuit."

Major Armstrong's invention is a very important step in the development of Radio. He has a considerable number of inventions to his credit. He perfected the ultra-audion, and the super-heterodyne circuits.

GRAND PIANO GIVES FORTH RADIO MUSIC

Somerville, Mass., Amateur Discovers Instrument to Be Resonance Repeater

SOMERVILLE, MASS.—It has been said that the amateur will perfect Radio—and now comes a new wrinkle from a Somerville amateur, receiving broadcasts with a small, inexpensive set and using a grand piano as a resonance repeater. The amateur is Alexander McIntosh, of 75 Boani street, Winter Hill, Somerville, who entertains his neighbors often with music received over his little \$7.50 Radio set and then repeated by means of the grand piano.

The piano repeating system was discovered by Mrs. McIntosh while her husband, with the headphones over his ears, sat listening in near the piano. She heard the broadcast music plainly, as it came in from the big station at Medford Hillside. McIntosh is a mechanic, and he calculated that the phenomenon was caused by the sounding board of the piano. Lifting up the top, he placed the earphones on the wood strips above the piano wires.

There was no sound in the room, but friends outside in the yard rushed in and declared that they could hear the broadcast outside where they had been. The windows were open and there was a breeze. Three times the new form of repeating was tried, and neighbors living several hundred feet away heard the music plainly. On other occasions, when it has been impossible to get this result, there was no wind blowing.

Government May Give Radio Sets to Consuls

(Special to RADIO DIGEST)

WASHINGTON.—The establishment of Radio receiving stations in the 31 branches of the Bureau of Foreign and Domestic Commerce in various parts of the United States is under consideration by officials of the Department of Commerce. The idea is that when important trade information is cable to Washington this information can be broadcast by the Department of Commerce to its various branches, who in turn can immediately make the information available to publications and individuals interested in export trade.

Michigan Wants State Radio

DETROIT.—Michigan officially is to install a Radio system that is the first of its kind in America, using thirteen of the Shipping Board radio sets as its operating equipment. Several other States have made inquiry at the Radio Section of the Department of Commerce concerning the licensing of State radio systems. The department is of the opinion that point to point Radio stations should be discouraged except in States where Radio is practically the only means of effecting dependable communication or the destruction of existing systems is threatened.

"Northeast" Radio in Arctic

NEW YORK.—The farthest north Radio station is located on an Arctic island 600 miles northeast of Norway, which serves as a weather outpost of that country by sending warnings of approaching storms.

Radio Digest Illustrated

TRADE MARK
Published Weekly by E. C. BAYNER, Publisher
123 West Madison Street, CHICAGO, ILLINOIS

Subscription Rates
Yearly.....\$5.00 | Foreign.....\$6.00
Single Copies, 10 Cents

Entered as second-class matter April 27, 1922, at the postoffice at Chicago, Illinois, under the Act of March 3, 1879.

Vol. 1 Chicago, Saturday, July 1, 1922 No. 12

CONTENTS

| | |
|--|----|
| Gives Broadcasts Pep; State Broadcasts Plan of Yankees; Plan to Radiophone Politicians' Oratory; Kansas Plans Show During September; Normandy Located by Radio; Cincinnati Holds First National Radio Holiday; Radio Control for Elephants Latest..... | 1 |
| Armstrong Demonstrates New Super-Regenerative Receiving Circuit; Marconi Has New Invention; Michigan Wants State Radio..... | 2 |
| Expert Predicts Radio Exchanges; British to Issue Airphone Permits; To Use Radiophones in Rescuing Miners; Relay Voice Long Distance New Way; The Antenna Bros. Cartoon..... | 3 |
| The Airphone in Your Summer Camp; Small Homemade Receiving Set; Springs Reduce Vibration; Spark Gap Protects Set Without Use of Switch..... | 4 |
| Hoosierland's Oldest is WLK; Twenty Watt Station of Fort Worth, Texas..... | 5 |
| New English Radio Concern Organizes..... | 6 |
| Radiophonist's Mart a New Feature Telling of the Latest Products Introduced by Manufacturers; Set Uses Mexican Parts; B Battery Dangerous to Filament..... | 7 |
| Radiophone Broadcasting Stations..... | 8 |
| Fire Underwriter's Rules Said Narrow..... | 9 |
| EDITORIAL | |
| Industry's New Doctors; Broadcasters Should Repeat Calls; The Underwriter's Philosophy; From Those Who Are Helping Radio; Radio Indi-gest, Humor Column..... | 10 |
| The Plain English of Ether and Ether Waves; by Letson Balliet; Construction of an Inductance or Tuning Coil. How to Make a Socket Aerial..... | 11 |
| Radio Telephony for Amateurs and Beginners, by Peter J. M. Clute, Part VI; Vacuum Tube Detectors; Oil Soaked Galena Aids Signals; Aerial Loop Lead Stops Static; How to Care for the Crystal; The Terms Hard and Soft Tubes..... | 12 |
| Simple Instructions for the Beginner, by Harry J. Marx..... | 13 |
| Diagrams and Hook-Ups..... | 14 |
| Questions and Answers..... | 15 |
| RADIO ILLUSTRATED | |
| Latest Pictures in Radio..... | 16 |

Looking Ahead

The Batteries. The Eighth Article of the Series by Peter J. M. Clute. All about the Batteries will be the Text of this subject. Standardized Series Covering Panel Units for Different Types of Tuners, Radio Frequency and Audio Frequency. There will be a special feature showing the Circuits. This Series will be written by Harry J. Marx. They will start in a future Number of Radio Digest. "How to Make Department." Summer Ideas for Making and Using Sets will Predominate in the Coming Numbers. Broadcasting Directory. Correct Station and Schedule List. The List Grows all the Time. Famous Stations You May Have Heard. One or More of These Stations are Shown Each Week. Radio Illustrated. You will see all of the Very Latest Pictures on this Page.

ON YOUR VACATION You'll Want

Radio Digest SUBSCRIBE NOW!

Copies Will Follow You Wherever You Go Send in the blank today

Publisher,
Radio Digest, Illustrated,
123 West Madison St.,
Chicago, Illinois.

Please find enclosed check M. O. for Five Dollars for One Year's Subscription to Radio Digest, Illustrated.

Name.....
Address.....
City..... State.....

EXPERT PREDICTS RADIO EXCHANGES

HETERODYNYING TO SOLVE THE SECRECY PROBLEM

Professor Fessenden Claims Airphone
Centrals Are Possible Within
a Few Years

(Special to RADIO DIGEST)

BOSTON, MASS.—Various Radio frequencies called, in Radio parlance, "heterodyning" will soon solve the Radio secrecy problem, according to Prof. Reginald A. Fessenden, one of the most prominent Radio experts in the country. Prof. Fessenden says:

"One of the features which will, in my opinion, render Radiophone communication between city subscribers not only possible but practical, is the method of heterodyning, which, in simple, brief language, is the production of an audible beat by introducing a second Radio frequency into the receiving circuit of the receiving station.

"For example, the fact that the subscriber heterodyning at the receiving end can make a modulated transmitted wave give any tone in the speech spectrum that he desires by simply changing his local frequency.

"A second feature is the ability to tune, that is, to select to four different characteristics, i. e., first and second, tuning wave frequency to an inaudible sound frequency and to a tone frequency; third, the ability to project the Radio messages in any desired direction by means of small projectors about two feet in diameter; and fourth, the ability to break up the voice spectrum into elements which transmit, each element on a different wave length and recombining the elements on the receiving end.

Like Yale Lock

"This principle is not unlike the Yale lock idea and one successfully tried out years before there was any demand for it. There are other considerations, also, which cannot be published at the present time, but all these combined are of such character as to make me feel justified in saying that, far from a direct intercommunicating Radio exchange being an impossibility, it will not be many years before numbers of such exchanges will be in practical operation."

While at the present time Prof. Fessenden is not doing any great amount of Radiophone work except that which is used in his latest experiments in astronomy and weather observation work, he is conceded to know more about the development of the Radio than any other man in the East. He is watching with an eager eye the growth of the Radiophone which he first used in experiments more than 22 years ago.

Among the outstanding achievements credited to Prof. Fessenden are the score or more patents which, although granted during the past twenty years, are today the identical devices which make Radiophone broadcasting and reception possible.

TO USE RADIOPHONES IN RESCUING MINERS

Bureau of Mines to Establish
Safety-First Stations

WASHINGTON.—The possibilities of the Radiophone in connection with mine-safety and mine-rescue work has been suggested to the United States Bureau of Mines. The suggestion has been made that, by use of high-power sending stations at the bureau's experiment stations at Pittsburgh, Pa., and Salt Lake City, Utah, messages could be broadcast to the various mine safety offices and cars stationed throughout the country.

HOOSIER NEWSPAPER INSTALLING STATION

HUNTINGTON, IND.—The Press of this city is installing a Radio broadcasting station, with the idea of using it in its own circulation radius. This appears to be the first newspaper having less than 5,000 circulation to invest in a broadcasting station. Whatever the possibilities are the Press wishes to do its part in furthering the development of Radio.

VARSITY UNDERGRADS MAKE VACUUM TUBES

THE students at Cornell, are not satisfied with just making receiving sets, for they have turned their attention to making vacuum tubes. As this work requires skill both in the glass work and in the element making, it is a tribute to their ingenuity that they have succeeded in producing a workable valve which operates as efficiently as the manufactured article.

PRETTY COAST RADIO CANOE GIRL



Miss Ann May, Pacific coast summer girl, in her canoe equipped with Airphone © INT.

BRITISH TO ISSUE AIRPHONE PERMITS

POST OFFICE BROADCASTS
AT NOMINAL FEE

New Plan Insures Future of Radio in
Europe—Marconi to
Broadcast

(Special to RADIO DIGEST)

WASHINGTON.—Speaking in London recently Postmaster General Kellaway, of Great Britain, announced the completion of plans for Radio telephone broadcasting by the General Post Office at a nominal sum to patrons for a permit, which will be the only expense involved. The normal hours for broadcasting will be from 5 p. m., to 1 p. m., except on Sundays when there will be no limit. Certain regulations are to be issued later with regard to the character and class of news which the authorized agencies will be allowed to transmit.

Until last September the manufacture, sale, or possession of Radio apparatus was greatly restricted by the general post office. The authority of the post office is limited now only to that conferred by the Wireless Telegraphy Act of 1904, which requires the possession of a license before any wireless apparatus can be installed or worked.

Listen to Dutch Station

For these reasons, Radio telephone broadcasting in Great Britain has heretofore been limited to occasional demonstrations by the General Post Office and the Marconi Company. As late as last October, the Wireless World, of London, was receiving subscriptions from Radio amateurs in England to insure the continuance of the Radio concerts conducted by the Nederlandsche Radio Industrie at the Hague.

The Marconi Company has recently announced its intention to broadcast Radio telephone news and concerts. The general development of the field by the post office, however, will be much more far reaching in its effects, not only in dissemination of news and revolutionizing methods of instruction, but in establishing a new industry.

Relay Voice Long Distance New Way

Message Sent Over Eleven Miles of
Wire—Sender Half
Mile Away

CINCINNATI, OHIO.—During flag day exercises here programs were delivered by an unusual broadcast performed by the Precision Equipment Company. As the exercises were to be held less than a half mile from the broadcasting station it was supposed to be an easy matter. It was found impossible, however, to secure a direct line and the only arrangements that could be made was to use a loop of eleven miles of wire, which ran through the telephone exchanges. The voice was finally passed over this great stretch of wire satisfactorily and transferred to the air at WMH.

FIND RADIO CAMPER DEAD

Unknown Fan Meets End in Indiana
Sand Dunes

CHESTERTON, IND.—The unidentified man who lost his life recently in the sand dunes near this place was camping alone, but he kept in touch with the outside world on this outing with a Radiophone receiving set which was found in his camp together with his gun and camper's kit. The Radio instruments may prove a clue to his identity.

NAVY DISPOSES OF TUBES

Bachrack Brothers of New York Buy
30,000 Surplus

(Special to RADIO DIGEST)
BROOKLYN, N. Y.—The Navy has sold its 30,000 surplus Radio transmitting tubes to Bachrack Brothers of New York at \$2.51 each. The successful purchaser was not high bidder, but due to the elimination of some bids which did not comply with technicalities, this company secured the award.

Boston Inventor Gives Circuit Demonstration

(Special to RADIO DIGEST)

BOSTON, MASS.—A practical demonstration of Radio frequency amplification in connection with a loop antenna was given recently at a meeting of the C. W. Club of Boston, by Sewell Cabot. Mr. Cabot has recently secured a patent on a circuit which greatly reduces regeneration within the circuit of a Radio frequency amplifier, thus increasing the efficiency of it.

THE ANTENNA BROTHERS

Spir L. and Lew P.

Part I—Next Week Tells

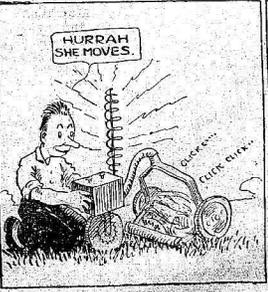
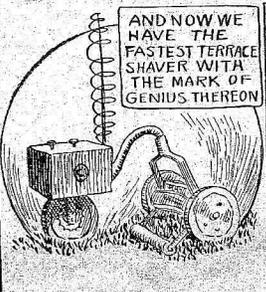

The Airphone in Your Summer Camp

Easy to Receive Music and News Out-of-doors

Miles away from the city, camping in a wilderness, Radio takes away that lonely feeling that comes after the sunset when the campers lie by the campfire and wonder whether a game of cards or some story telling will best pass away the

WORKSHOP KINKS? EARN A DOLLAR—

THERE are many little kinks worked out at home that would aid your fellow Radio worker if he only knew about them. There are new hook-ups, new ways of making parts and various unique ways of operating sets that are discovered every day. RADIO DIGEST is very much interested in securing such material. Send them in with full details, including stamped envelope so rejected copy may be returned. The work must be entirely original.

RADIO KINKS DEPARTMENT,
RADIO DIGEST,
123 West Madison St., Chicago, Ill.

evening. Stealing through the ether come the Radio waves of song and music, bringing to the lonely campers a new diversion heretofore unknown on their trip. The transformation requires no skill, no complicated set-up, just a single wire antenna, a copper stake in the ground, the necessary connections, the well known cabinet set with either receivers or loud speakers and the program from the city entertains the vacationists in any part of the country. The broadcasting areas overlap each other to such an extent that there are but few places in the country where reception can not be relied upon.

No Landlords in the Country

Away from the cities, with the steel buildings, power wires and central stations, creating constant interference, the camper in the country has a decided advantage in receiving even with what may otherwise be but a mediocre set. Of course it must be understood, that the crystal set cannot be depended on to carry over a range greater than 20 to 25 miles except under unusual conditions. But with the vacuum tube sets, usually with about two steps of either radio or audio frequency amplification or even both, the camper need not fear that the results will not be worth the trouble.

No grouchy landlords to protest about the erection of an aerial on the roof. No limit of length need worry the operator. Unlimited distance is available, only the height has its limits and that need not be a serious difficulty. Ability to climb the tallest tree is not all that is needed. Or if that is lacking, a rope thrown over one of the higher branches and the antenna can be pulled into position.

Antenna Fastened to Tree

The first step then is to consider the necessary antenna equipment. Two Insulators, 150 feet of strand wire of some good sash cord and about 50 feet of lead-in wire will complete the antenna equipment. A good high tree, without an overabundance of branches and with a clear space on one side for an unobstructed aerial, is necessary. The insulator is fastened to the cord, and the other end of the cord is fastened to the tree as high as possible, allowing the insulator to swing clear of all branches. The antenna wire is then passed through and fastened to the insulator. The other end of the aerial wire is likewise passed through a second insulator and this can be fastened by means of the sash cord to a shorter pole or another tree, so that the aerial has a length of at least 100 to 150 feet. The antenna can be horizontal or slope down as shown, as long as it does not touch the branches of any trees. The lead-in is fastened at one end and runs down to the antenna binding post of the set.

Ground System Simple

The ground equipment consists of a copper coated stake about five feet long and about 1/2 inch thick, together with a clamp and some more lead-in or ground connection wire. A lightning arrester is unnecessary, as the Board of Underwriters will not be sniping around the aerial can be directly connected to the ground stake if the ladies in the party fear a fire.

The stake should be driven into some good moist ground. To improve the conditions a hole can be dug and some salt packed in, and the stake driven in through the salted area. About 6 to 12 inches can be left projecting for the clamp and ground connection wire which is fastened to the ground binding post on the set.

The Dance Floor

Of course a little foresight is necessary. A clear spot should be selected, where the dancing to be possible. Be sure to clear off the floor, as the moonlight comes at a bad time to think of

HOW TO SET UP CAMP RADIO

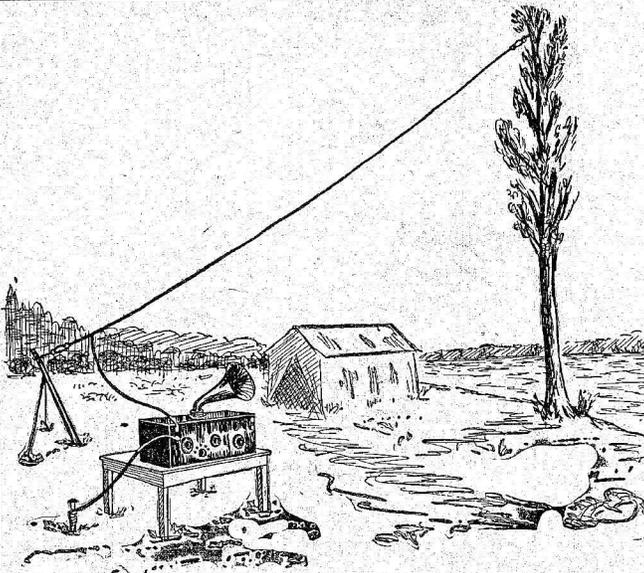

stones and ruts to stumble over. Or if the dance floor is impractical, at least have the set near the fire, and some cozy bunks nearby where the little fellow cupid can get in some of his good work.

The reception in the country under camping conditions is always surprising, and many a disgruntled Radio fan has been tickled with delight because the old bugbear STATIC wasn't following him around on his vacation trip after all. The trouble is that the old alibi of static is passed off by many simply because of lack of common sense in tuning the set. So don't let the other fellow discourage you, but take the little old Radio set with you on your vacation trip and you'll come back a bigger bug than before.

Springs Reduce Vibration

Microphonic noises are sometimes very annoying where there are circuits employing several stages of amplification. Should there be something dropped on the oper-

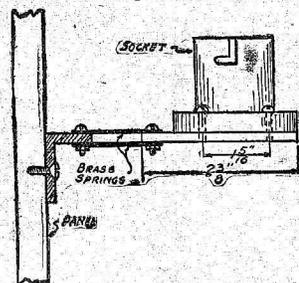

ating table an enormous boom is heard in the receivers. Any vibration near by is repeated in the phones. This can be somewhat eliminated by mounting the socket on springs. The illustration shows a very simple method of making this mounting.

Small Home Made Receiving Set

The illustration accompanying this description shows my Radio set which has received Radiophone concerts for a distance of 23 miles. It consists of a home-

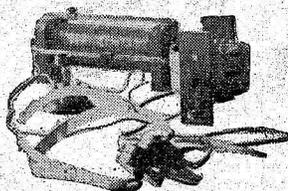

made double slide tuner of the ordinary type, wound with No. 28 enameled copper wire on a 2 1/2 inch solid wooden core. The variometer is made of cardboard, the larger being 4 inches in diameter and the inner 3 inches, both wound with 35

turns of No. 22 single cotton covered wire on each side of the tube, leaving a 3/8 inch space in the center for the shaft.

I use a Universal crystal detector with

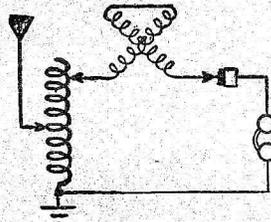

a mounted galena crystal and Murdock 3,000 ohm phones. It will be noted that no fixed condenser is used. Although this may be an advantage, I have obtained better results without it.—B. F. Willard.

RADIO SUPPLIES STORES

Prompt Service—Quality Goods—Priced Right
Radio Division
TELEPHONE MAINTENANCE CO.
25 S. Wells St. Franklin 3986
5206 W. Madison, Ans. 7041. 1122 E. 47th St.

Look for the TELMACO Sign

Spark Gap Protects Set Without Use of Switch

The usual method for protecting a Radio receiving set from lightning is to use a double-throw double-pole knife switch. These switches are expensive, too much so for the average amateur. Another way

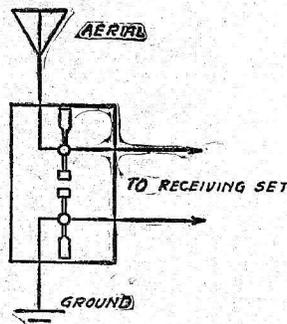

of protection and one that is not so costly is to use a spark gap of the stationary type—the kind used in spark coil transmitters are just the thing.

These spark gaps are easily made if one has a good base, such as porcelain, slate or bakelite, and some brass or copper electrodes. Do not have more than an eighth-inch space between gap points.—R. W. Tanner.

Distributors FOR

DeForest Radio Sets

All Types
IMMEDIATE SHIPMENT
Head Sets
Vario-Coupler
Variometers
and all necessary parts
for constructing your
own set.

Write for Complete Price List
Special Discounts to Dealers



42 South Wabash Avenue
Dept. R. D. Chicago

SELECTOR

A selective radio contact switch. For varying the number of turns in any kind of radio tuning coil.

The SELECTOR can be mounted on coupler or coil direct, thus reducing leads to a minimum. Short leads and positive contact in radio instrument wiring are not only necessary, but are imperative for highest efficiency.

The SELECTOR combines these essential features and in addition is compact, positive and will give that commercial appearance to your panel.

ROTORS AND STATOR SECTIONS

Carefully and accurately made from specially selected and treated woods. Not "mere wood turnings," but manufactured to pattern makers standard.

Rotors packed 50 and 100 in package. Stator sections packed 100 and 200 in package.

Dealers! Send for interesting circular and attractive proposition.

NORRIS ELECTRICAL SPECIALTIES CO., Inc.

126 Liberty Street
NEW YORK CITY
Telephone Rector 6669

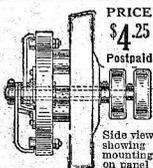

PRICE \$4.25
Postpaid

HOOSIERLAND'S OLDEST IS WLK

Plant Owned Jointly by Indianapolis News, L. S. Ayers and F. F. Hamilton

Broadcast Early in 1920

Aided in Spreading News of Speedway Classic—Was Formerly Station 9ZJ

By Thomas A. Hendricks
(Special to RADIO DIGEST)

With a record of having broadcast its first Radio telephone entertainment May 10, 1920, WLK, the Indianapolis News-Ayres-Hamilton broadcasting station holds the honor of being the oldest Radio establishment in Hoosierland. WLK with its high aerial poles towering above the surrounding houses, far from electric sign boards and street car trolley lines and other interfering bodies is owned and operated by Francis F. Hamilton, Radio editor of The Indianapolis News and widely known throughout the state as the "Radio Rajah of Indiana." The station is situated at 2411 North Alabama street, being at heart a purely amateur undertaking, being planned, built and operated by Francis F. Hamilton himself.

Started When Youngster

By slow but effective steps WLK has developed from an amateur's toy with which Mr. Hamilton amused himself when a mere youngster in short trousers until now it is rated as one of the best known Radio stations in the central west. At the present time WLK is using four 50-watt tubes, two serving as oscillators and two as modulators, while two 6-watt tubes serve as speech amplifiers. The speech amplifier tubes are so arranged that they may be used for one microphone or for two microphones, one on each tube. WLK's radiation is three amperes on 360 meters wave length and 4 1/2 amperes on 485 meters. Under good conditions the daylight range of the station is approximately 700 miles and the reports of the 800-mile automobile race at the Indianapolis Motor Speedway, which were broadcast from WLK throughout the day of the race, May 30, were received as far away as New York state. At night the average range of WLK is 1,000 miles, but with the finest possible conditions the station has been heard in San Francisco.

Installing Thousand Watt Set

At the present time Mr. Hamilton is putting in a 1,000 watt set which he hopes to have in full operation for the first cool evenings of the fall when broadcasting conditions reach normal pitch once again. WLK under its present schedule gives a musical and entertainment program three times each week, on Sunday, Tuesday and Thursday evenings. Daily broadcasts include notes on the crops and weather, financial statements, style talks, readings, selections on the phonograph and other of the usual features sent out by broadcasting stations throughout the country.

Long before he ever dreamed of such a thing as a telephone station back in 1908-1909 he sent spark messages which were received throughout this section of the country and finally Hamilton received his amateur operator's license and the call number of 9ZJ, which he retained until the present license under which his station is operating was awarded last January. Mr. Hamilton's station was the only station west of Pittsburgh that Paul Godley was able to catch when he made his special trip to Scotland to copy American amateur stations. The WLK antenna is of the horizontal cage type.

Against Airphone Advertising

Only in the last few months has WLK become the Indianapolis News-Ayres-Hamilton station, the Indianapolis News and L. S. Ayres & Company taking over an interest in the station although Mr. Hamilton has kept his programs as free from advertisement as is possible.



F. F. Hamilton, designer of WLK

"In Radio as in all movements of a public nature evils are attached which if permitted to accumulate, always lessens the great value of that movement," Mr. Hamilton says. "Already in Radio telephone broadcasting, business men have seen the wonderful possibilities of advertising their products by Radio telephone and stations are contemplated with the idea of being operated especially for advertising service. These new companies plan to broadcast twenty-four hours a day, seven days in the week, permitting any retail store or mercantile firm to buy five or ten minutes time each day to advertise their products whether these be soap, shoes, furniture or silvers. In order to keep Radio broadcasting on the high plane it should maintain in the eyes of the public, it must be handled as a sport. Radio is a sport today just as much as it was five and ten years ago when it was the big pastime for amateurs."

Invites Inspection of Visitors

With the completion of the 1,000 watt station, which will make WLK the highest powered broadcasting establishment in the state of Indiana and with the remodeling and decorating of the WLK studio, Mr. Hamilton hopes to have one of the real Radio show places in the central west next fall, and cordially invites all visitors who come to Indianapolis to give his station a "once over" when they are in the Hoosier capital.

Mr. Hamilton with Thomas A. Hendricks, of the feature department of the Indianapolis News, write the "Jimmie and Dad Radio Stories" that are being published through the Bell Syndicate, Inc., in many of the leading papers of the country.

Prep School to Teach Radio

Columbia Preparatory School is the forty-second institution of learning to announce a course of instruction in Radio science. The course will be a short one, as most are, and will give the student a practical knowledge of the new art.

The many motor-generator sets shown below supply the current necessary to operate WLK.



Twenty Watt Station of Fort Worth Star Telegram Heard Over Wide Area

WBAP Frequently Heard in Denver—Market Report Service Proves Beneficial to Texas Ranchers—Static No Obstacle to Rapid Growth of Radio Popularity

(Special to RADIO DIGEST)

Remarkable results have been obtained by Station WBAP, the broadcasting plant of the Fort Worth, Texas Star Telegram, using only 20 watts of power, since the establishment of the station some two months ago.

The programs of this station have been heard on a crystal detector set 65 miles from Fort Worth, while in Denver, 805 miles away, the music sent out by WBAP is frequently picked up by sets using only a single detector tube without amplification.

The present broadcasting set of the Star Telegram, which is temporary pending delivery of larger equipment, was made in Texas and has some rather unique features. Six hundred volts are used on the plate and a radiation of 1.8 amperes is obtained in transmitting. The circuit used is a modified Heising with four oscillators and four modulators. The motor generator is of 200 watt capacity and a Ford coil is used for a modulation transformer. No voice amplifiers are used except for the broadcasting of church services every Sunday morning when a three stage speech amplifier is employed.

Filter Circuit Eliminates Hum

The filter circuit consists of two, one Henry capacity, chokes and a 24 M. F. D. condenser which eliminates all generator hum and in large measure accounts for the exceptional results obtained on the present equipment. All tubes are lighted off alternating current from one transformer without a center tap. The tube elements are perfectly cool at all times.

The aerial used on this set is 80 feet long, consisting of a six wire cage, and a lead-in wire 105 feet long. The aeriels are 150 feet above the ground. No counterpoise is used.

Programs sent out by WBAP start at 8:45 o'clock in the morning and continue half hour periods at various times during the day and evening until 11:00 o'clock at night. The programs include market reports of all kinds, Texas road condition reports, kiddies' bedtime stories, health talks, special speakers of note, concerts of local and national artists, baseball returns, etc. The latter feature is proving to be very popular. In many towns throughout Texas and Oklahoma, served by the WBAP programs, Chambers of Commerce, American Legion posts, hotels, stores, schools, colleges and universities, and even drill-

ing rigs in the oil fields have installed sets equipped with loud speakers where the Radio fans gather each evening with ready pad and pencil to take down the scores.

Market Reports Interest Many

Another feature that is proving of paramount value to the interests of this section of the country are the Radio market reports, and many organizations in the State are receiving this service daily, posting a stenographer at the receiving set and later posting the quotations on a bulletin board. The market reports thus received are from 12 to 24 hours ahead of other means in many communities.

Texas is responding to the Radio call with a rush and hundreds of receiving sets are being installed each week throughout the Southwestern country. Despite the fact that static is particularly troublesome in the plains country west of Fort Worth, and for that matter anywhere in Texas during the hot weather, many ranchers are putting in sensitive receiving sets to obtain the cattle market. Isolated ranches, far from a railway and still farther away from a daily newspaper are now by virtue of Radio in as close touch with current events of the World as if they were on the outskirts of a city. The benefits to the ranching country that Radio developments hold are hard to estimate.

Reports to The Star Telegram Radio station show that between 150 and 200 cities and towns in Texas and Oklahoma listen in daily on WBAP station. In the smaller towns the evening Radio program is received on the most sensitive set in the community, usually equipped with loud speaker, and the gathering of the people to hear what the Radio has in store for them each evening has developed already into a firmly fixed institution.

Develops Radio Receiving Set

(Special to RADIO DIGEST)

BROOKLINE, MASS.—A Radio receiving set with but one stage of Radio frequency amplification and with no outside aerial is the latest invention of Sewall Cabot of this town. The new set is claimed to practically eliminate static. It uses a loop aerial, but unlike the ordinary loop, this is constructed of brass rods instead of wire.

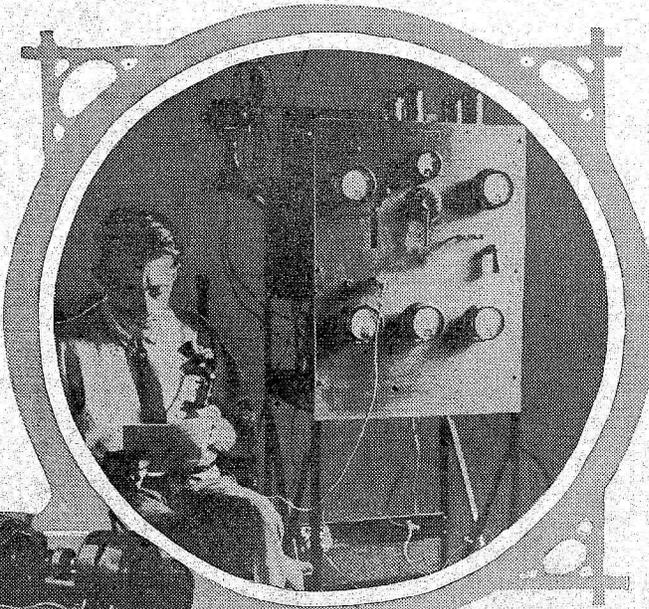

The voice of E. R. Churchill, sitting by transmitter panel above, is heard every night all over Indiana. He is official announcer. Note fan to cool tubes.

FISHERMAN MAKE USE OF AIRPHONE

PLAN TO GUIDE GLOUCESTER SALTS BY RADIO

Other Compass and Broadcast Programs to Be Aailed—Plan Co-operative Transmitter Also

(Special to RADIO DIGEST)

GLOUCESTER, Mass. — Fishermen on the Grand Banks out of Gloucester and probably Boston will be guided and called to port by extensive use of the Radio-phone, according to present plans of the owners of the Gloucester fishing fleet, who will install Radio equipment on their vessels immediately. Gloucester fishermen and owners of vessels are canny folk, and quick to make use of any innovation that will enable them to handle and market their wares more quickly and for greater profit. They were the first to make use of the aeroplane in scouting for schools of mackerel, a feat which had considerable success.

Plans are complete for the installation of Radiophone equipment on the Schooner Glide Wilson, which will be ready by the time this is in type. Other boats of the big fleet will be equipped in turn by Carl W. Berg, a well known Radio engineer.

Plan Large Broadcast Station

Not only will the vessels carry receiving sets, but it is planned to build and equip a big transmitting station, controlled by co-operative syndicates of ship-owners in Gloucester. This broadcasting station will bring the Radiophone into real first class commercial use—the first instance of its kind in the world.

From the station the central broadcasting will not only be in constant touch with each fishing vessel, but will be able to transmit orders to the various skippers ordering them into port whenever prices are most favorable, and also enable the men out on the banks to keep in touch with market prices at Boston and Gloucester and work accordingly. The men will also be provided with the broadcasting Radiophone entertainment.

New English Radio Concern Organized

Plans to Open Communication Between Canada, Australia and England

WASHINGTON, D. C.—According to a report to the Department of Commerce from Consul General Sammons, Melbourne, direct Radio communication between Australia, Canada, and Great Britain, supplementing the "All Red" cable line of the Pacific Cable Board, is likely to be established within two years as a result of a contract just concluded between the Australian Government and the Amalgamated Wireless Co., Ltd.

The main Australian station will probably be located in New South Wales. According to the Melbourne Argus the power used will be about 3,000 kilowatts and the combined cost of the central station and of a feeder station in each of the six states will be £1,000,000. The plant for the central station will be manufactured in England, but those for the smaller stations will be made in Australia.

The controlling interest in the Amalgamated Wireless is vested in the Commonwealth Government and of the seven directors the Government and the minority stockholders will each have three, the seventh being chosen by vote of the first six. An important clause is that prohibiting the Amalgamated Wireless from combining with any other commercial interest and requiring it to remain always "an independent British concern."

The company is also to develop manufacture, and sell Radio apparatus and to furnish service to ships and aircraft. It has been made a party to the general agreement for the interchange of Radio patents entered into by the principal Radio equipment companies of the world.

New high power Radio stations to communicate with Australia are planned for Great Britain and Canada. The proposed rates for services are about two-thirds of the present cable rates.

Radio Equip 16-Story Building

SAN FRANCISCO—Radio telephone will be part of the standard equipment in the new 16-story Matson Navigation company building now under construction here, according to an announcement made today by company officials. As far as is known the Matson building is the first to be equipped with Radio apparatus while in course of construction.

The service also will enable any tenant in the building to call up on the company's boats at sea with the same ease that he would call up his club.

Book Reviews

A B C of Vacuum Tubes used in Radio Reception. By E. H. Lewis. The text of this book is clearly written so that it will initiate the novice into what goes inside the receiving vacuum tube. Price, \$1.00.

How to Make a Commercial Type Radio Apparatus. By M. B. Sleeper. This book is well illustrated and it makes excellent instruction for the person who wants to make his own equipment like those of the commercial type. Price, 75c.

Radio Phone Receiving. Written by nine specialists. The last word in telephone receiving. Beautiful photos and simple diagrams accompanying text. Price, \$1.50.

Home Radio. How to Make It. By A. H. H. Verrill. This book is particularly adapted for the amateur that desires to know how to make Radiophones. Twelve full page illustrations and diagrams. Price, 75c.

Continuous Wave Wireless Telegraphy. By B. Mitchell. A non-mathematical introduction to the subject of wireless telegraphy from the engineer's point of view, with special reference to the principles, apparatus, and operation of continuous wave systems. Price, 85c.

Arithmetic of Telegraphy and Telephony. By T. E. Herbert and R. G. De Wardt. Students working through the book will not only acquire facility in making arithmetical calculations, but will also gain a good deal of information which will be useful to them in connection with their work. Price, \$1.50.

This book department of the Radio Digest is prepared to send you any of the books on Radio published, whether listed in our Book Review or not. Let us know what book you want, send us your check and we will see that the book is mailed to you. Book Department, Radio Digest Illustrated, 123 W. Madison St., Chicago, Ill.

Radio Insurance Now Obtainable for Sets

Now comes Radio insurance. Everything comes under the eyes of the insurance men at one time or another and the Radio is now the apple of the insurance agent's eye. With the constantly increasing number of Radio outfits being built, the insurance companies have begun to realize the business which can be gained by selling insurance on Radio outfits.

One large company has issued a blanket flatter Radiophone policy against the following risks: fire, lightning, burglary, theft and transportation and many other companies are following in their steps in the issuing of Radio insurance policies.

FREE!—FREE!

One Vacuum Detector Tube with each purchase of one

PENBERTHY

Radio Head Set

3000 Ohms Guaranteed

LIST PRICE..... \$10.00

OUR SPECIAL PRICE ON THIS DEAL

\$9.00

J. H. SULLIVAN

Room 602, 130 No. Wells St., Chicago, Ill.

★ Radio Bugs! ★

Try This on Your Cat's Whisker

To the tune of Yankee Doodle

Price **\$10**

Gregg's Listen In set. Is a marvel, you bet.

Through which the waves come a-buzzin'.

Attach to the phone. You now use alone.

And the program is heard by a dozen.

Yes, a dozen hear the news, A dozen hear the dandy.

Everyone should have Gregg's Set, Because it is so handy.

The family should get Gregg's Listen In set.

Does for all, even uncle and cousin.

No more all alone.

Does one use the phone.

The set sends it out to a dozen.

Write for Catalogue

Gregg Company

Room 505, 35 South Dearborn Street

CHICAGO

Civil Service Has Radio Positions to be Filled

Commission to Receive Applications—Many Pay Well

(Special to RADIO DIGEST)

WASHINGTON. — The United States Civil Service Commission announces that it will receive applications for an assistant Radio engineer up to July 11. The commission will hold an open competitive examination for this position to fill a vacancy in the office of the Chief of the Air Service, Washington, D. C., at a salary of \$2,400 per year.

The Commission will also hold examinations on June 21 and July 19 to fill positions of Radio inspector and assistant Radio inspector in the Bureau of Navigation, Department of Commerce, at salaries ranging from \$1,800 to \$2,200 per year. Applications will also be received up to July 18 for a vacancy as a Radio operator in the Lighthouse Service at Honolulu, Hawaii, for duty on the tender "Ku Kul" at \$960 a year, and at New Orleans, La., for duty on the tender "Magnolia" at the same salary.



TV-WAY Plugs; HOLD-TITE Jacks V. T. Sockets; Variable Condensers; Rheostats and Head-sets.

If your jobber is unable to supply, write us

RADIO FOR THE BEGINNER

tells you what you want to know about radio. It explains the principles of radio, the vacuum tube, radio tuning, etc., in plain language, and will help you make your set work better. Handy pocket size book, price \$1.00. Order to-day.

ALFRED FOWLER
19 Board of Trade, Kansas City, Missouri

RADIO MAILING LIST

6510 Radio Retail Dealers, per M. \$7.50
624 Radio Jobbers, for list. 7.50
624 Radio Manufacturers, for list. 7.50
and any other list you want.

Trade Circular Addressing Co.
166 W. Adams Street Chicago, Ill.
Phone FRANKLIN 1182

BUY GOLLY! Look at the Bargains IN RADIO

For Instance:
23 Plate Variable Condensers..... \$2.50
43 Plate Variable Condensers..... 3.50
3" Bakelite dials..... .75
3" Black Composition dials..... .50
Switch Points, 6 for..... .12
Binding Posts, Nickel..... .07
Binding Posts, Bakelite..... .09
5000 Ohm Turney Phones..... 6.29
Vartocouplers..... 4.50
Vartocouplers..... 4.50

All our supplies are guaranteed on a money back policy. Mail orders promptly filled, C. O. D. parcel post. In sending money orders include postage.

Prices on Unlisted Supplies Sent on Request
WRITE US FOR COPY OF OUR FREE WEEKLY

THE RADIO SHACK

419 West 42nd St., New York City
Address Dept. DI

Visit Booth 17 National Radio Show CHICAGO, ILLINOIS

Radio Sales & Service, Suite 1311, 38 S. Dearborn St., Chicago, Ill.

TRESCO

SECTIONAL UNIVERSAL

Licensed Under Armstrong U. S. Patent No. 1,113,149

Seven Years in Radio Think What That Means!

The Tresco Tuners were among the first ever made under the Armstrong patent. They are found in all parts of the world, giving satisfactory service. The sectional idea is original with Tresco.

The Set Consists of Three Units:

| | |
|--|----------|
| Tuner and Detector Unit | \$50.00 |
| Two-Step Amplifier Unit | 35.00 |
| Unit for holding "A" Battery | 9.50 |
| Top and Bottom, which when added to the three other units, make a complete section all in one. | |
| Each, \$5; both 10.00 | |
| Complete Set, total | \$104.50 |

The units when assembled make a cabinet 40 inches wide, 15 inches high and 10 inches deep.

Tresco Sectional Universals are being supplied to dealers and jobbers just as fast as possible. Order from your local dealer. If he cannot supply you, send us the price of set desired, and we will fill your order.

Dealers and jobbers are rapidly finding out that TRESCO is one of the very few manufacturers actually in position to take care of large volume orders for immediate shipment. Liberal discounts are given to jobbers and dealers for quantity orders.

We do not furnish vacuum tubes, head sets, batteries or loud speakers.

Used by All Over The World

Davenport, Iowa, U.S.A.

MITCHELL BLAIR COMPANY
1011 Hearst Building, 326 West Madison Street, Chicago
DISTRIBUTORS

The Radiophonist's Mart

A NEW development in the form of a vacuum tube rheostat with vernier adjustment, has been placed on the market by the Cutler-Hammer Mfg. Co. They are designed to carry one ampere, and have an operating range of from zero to four ohms. Two ampere may, however, be carried in an emergency.

This rheostat is designed along entirely new lines and incorporates many novel features. A "full off" position is provided, eliminating the necessity of additional switches in the "A" battery circuit. A "full on" position is also provided which makes total battery potential available, rendering charging unnecessary until its full voltage has dropped below tube requirements. A nicked pointer indicates at all times the amount of resistance in the circuit.

The spring contact fingers are adjustable, and are so mounted as to lie in the direction of travel of the resistor, insuring smooth, quiet, and positive regulation. The large number of turns of low resistance each cut out or in, one at a time, provides fine gradation of control, minimizing clicking in the receivers during filament adjustment.

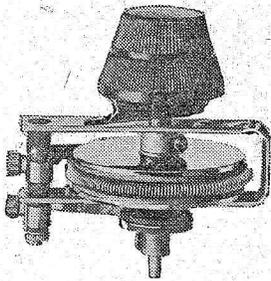

The rheostat is designed for panel mounting and is readily adjustable for panels ranging from one-eighth to one-half inch in thickness. Cone shaped knobs of genuipe Thermoplas are provided, which are of excellent appearance, and do not cramp or tire the fingers. All metal parts throughout are finished in highly polished nickel.

A NEW device to permit the most delicate tuning adjustments that ought to appeal to every Radio fan has recently been patented and is being marketed. The device consists simply of a turning knob which is fastened to the panel near the rim of the present dial. When it is pressed against the edge of the dial a rubber contact engages the latter and causes it to turn at about one-tenth the speed at which the knob is turned, enabling the most delicate adjustment to be made quickly and easily.

The vernier knob will work just as well

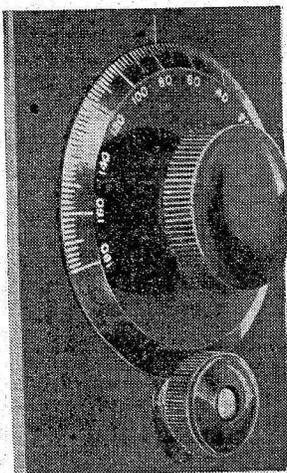

on dials that are out of alignment, twisted or eccentric. A valuable feature is the elimination of body capacity effects as well as the slight hand tremors which make tuning so difficult when the variometer bearings are not tight. As the connection between the vernier and the dial is not permanent but is merely engaged by hand pressure during adjustment, the dial is always free to turn as usual. Only one hole drilled through the panel is all that is necessary to install this attachment.

METERS FEATURE NEW RECEIVER

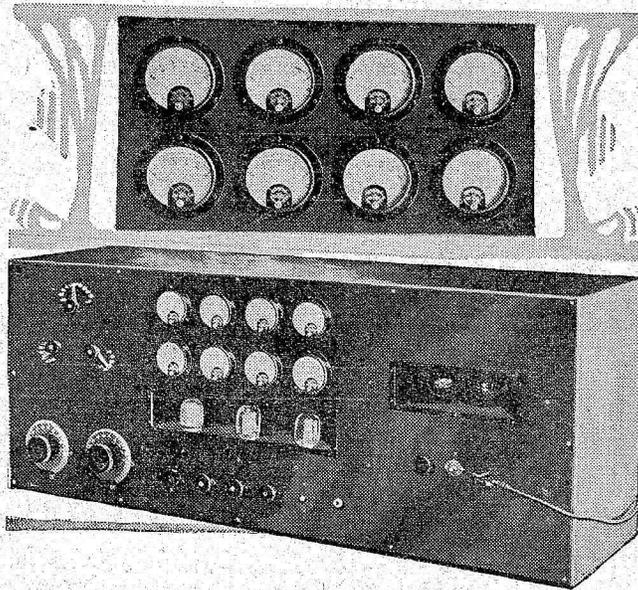

Parts and Accessories—

PLAY an important part in the life of every possessor of a Radio receiving set. New designs, inventions and the latest models are all news of the most welcome sort to the wide-awake fan. For this reason, RADIO DIGEST starts "The Radiophonist's Mart" with this number. The department will supplant the well-known "Radio Receiving Sets" feature, in which standard sets were described in detail both by an elaborate photo diagram page and by a careful and simple description of their operation. This has been deemed advisable as practically all standard instruments have been featured.

The new department will tell about the latest developments in Radio products, so that our readers may keep in touch with the enormous strides of the newly popular, yet old, field. Perhaps you are planning to add to your present apparatus. Maybe you have some changes in mind. Whether you have or not, you are interested in the latest developments in parts, accessories and complete sets.

Automobile owners buy accessories, new parts, and, in fact, the latest kind of cars. They watch the models brought out by the various manufacturers to see what suits them best, what is good, or bad, in the design, and conjunctively, to learn the news. Radiophonists are analogous to motorists. The Radio fan will therefore appreciate the new department starting this issue, for it will keep him posted on what kind of "car" to buy.

COMPACT Radio apparatus is an especially interesting feature to the novice who is planning a summer set. The smaller the cabinet can be made, the more useful it would be found for portability on the vacation trip. The estru variometers, and variocouplers have been designed for the maximum receiving efficiency, and embody small compact assembly without unnecessary framework. This efficiency is accomplished by the low capacity between wires due to the lattice method of winding, and low capacity between stator and rotor, due to the small size. These small units may be

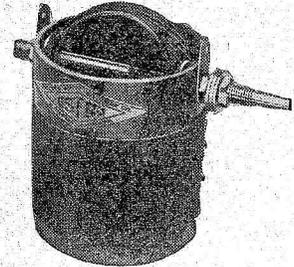

used in any standard receiving circuit, and are easily mounted either on panel, or on a base.

The instruments can be spaced as closely

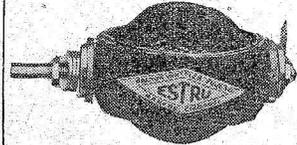

as possible, consistent with the mechanical requirements, and in case unstable conditions are set up due to the mutual inductance between variometers, the connections on one variometer need only be reversed.

Panel Uses "Meccano" Parts

Many an amateur can easily make a panel with fittings from some parts of his "meccano" or similar set and a cigar box. A tuning coil for this purpose can be made by winding wire (about No. 22 insulated) around a pasteboard box in which salt or rolled oats are sold, taking as many taps out as desired from the coil. The taps are

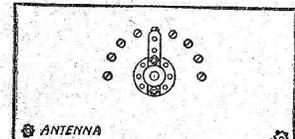

FRONT VIEW

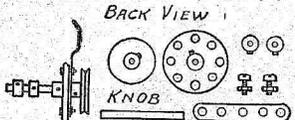
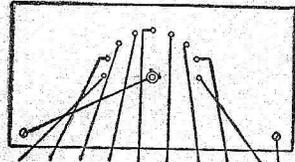

connected as shown in the illustration, using the nuts and bolts for the switch points. The illustration is self explanatory. The panel may be stained dark or enameled black to improve the appearance.

A home-made variocoupler may be mounted in the same way as the tuning coil, except that it has two knobs with switch points instead of one.—Joseph M. Manentum.

"B" Battery Hard on Filament

Don't confuse the wires of your "A" and "B" batteries. The "B" battery delivers from 24 to 100 volts according to the number of units hooked up together, and a current of this voltage passing through the filament of a vacuum tube will melt it made to burn on six volts, will melt it quicker than a flash.

Do You Buy Your Watch for Its Size? Will an Alarm Clock Do Just as Well?

Both Keep Time

VARIOMETERS ESTRU VARIOCOUPERS

ARE IN THE WATCH CLASS

THEY ARE SMALL, compact, design requires only 14 to 16 cubic inches of space in your cabinet. No unnecessary frame-work; weigh approximately 3 ounces. A careful try-out in your Set or Laboratory will convince you of their merits: Sharp Tuning—Low Distributed Capacity—Maximum Efficiency by Lumped Inductance.

If your dealer cannot supply you with this apparatus or any information which you may wish regarding same, write direct to

DALTON, WHITTIER, TRUE COMPANY

Manufacturers of ESTRU Products

2905 WEST MADISON STREET

CHICAGO, ILLINOIS

State, City, Call
 Pasadena, KDYR, KLB
 Pomona, KGT, KSL, KLB
 Reedley, KMC
 Redwood City, KDYN
 Sacramento, KVG
 San Diego, KDT, KDYM,
 KDYO, KYF
 San Francisco, AGI, KDN,
 KDZG, KDZV, KDZX,
 KGB, KFO, KSL, KUO
 San Jose, KQW, KSC
 Stockton, KJQ, KWG
 Sunnyvale, KJJ
 Colorado Springs, KHD
 Denver, DD5, KDYY,
 KDZU, KLZ, KOA

Connecticut:
 Greenwich, WAAQ
 Hartford, WDAK
 New Haven, WCJ

District of Columbia:
 Washington, WDM, WDW,
 WEAS, WJH, WJL
 WMU, WPM, WXX,
 WYD

Florida:
 Jacksonville, WCAN,
 WDAI
 Tampa, WDAE, WEAT

Georgia:
 Atlanta, WAAS, WDAW,
 WGM, WSB, WGD
 College Park, WDAJ

Illinois:
 Chicago, KYW, WAAF,
 WBU, WDAF, WGU
 Decatur, WBAQ, WCAP
 Peoria, WBAE, WFAP
 Quincy, WCAW, WCZA
 Springfield, WDAE
 Tuscola, WJZ, WJZ, WJZ, EXAI
 Urbana, WRM

Indiana:
 Anderson, WMA
 Fort Wayne, WPAZ
 Indianapolis, WLK, WOH
 Richmond, WOZ
 South Bend, WBAQ
 Terre Haute, WBAE
 West Lafayette, WBAA

Iowa:
 Ames, WOI
 Centerville, WDXA
 Davenport, WOC
 Des Moines, WGF
 Fort Dodge, WBAE
 Iowa City, 9YA
 Sioux City, WBAU
 Waterloo, WEAZ

Kansas:
 Anthony, WBL
 Atwood, WBAE
 Eldorado, WBT
 Emporia, WAAZ
 Lindsborg, WDAE
 Manhattan, WTK
 Salina, WFAE
 Wichita, WAAE, WEAH,
 WEY

Kentucky:
 Louisville, 9ARU

Louisiana:
 New Orleans, WAAB,
 WAAC, WBAM, WCAG,
 WGV, WWL
 Shreveport, WAAG, WDAE

Maine:
 Auburn, WMR
 Sanford, WPAR

Maryland:
 Baltimore, WCAO, WBAE,
 WKO

Massachusetts:
 Boston, WAAJ
 Medford Hillside, WGI
 New Bedford, WDAU
 Springfield, WEEA
 Worcester, WCN, WDAE,
 WDAT

Michigan:
 Bay City, WTP
 Dearborn, WWI
 Detroit, KPO, WCX, WWJ

State, City, Call
 East Lansing, WJW
 Flint, WEAA
 Grand Rapids, WJAC

Minnesota:
 Hutchinson, WFAN
 Minneapolis, WAAL,
 WABD, WBAH, WCAS,
 WCB, WJL
 Redfield, WCAL
 St. Cloud, WFAM
 St. Paul, WAAH

Missouri:
 Cameron, WFAK
 Emporia, WFAQ
 Columbia, WAAN
 Jefferson City, WOS
 Kansas City, WDAF
 Warburg, WQQ, WFB
 St. Joseph, WBAK
 St. Louis, KSD, WAAE,
 WCK, WEB, WEW

Montana:
 Great Falls, KDYS

Nebraska:
 Lincoln, WCAJ, 9YY
 Omaha, WAAW, WOU,
 WOV
 Rushville, WEAV

Nevada:
 Reno, KDZK, KOJ

New Hampshire:
 Berlin, WEAQ

New Jersey:
 Camden, WRP
 Dept. Beach, EXJ
 Jersey City, WAAE
 Moorestown, WBAE
 Newark, WAAM, WBS,
 WJLX, WJZ, WJZ, EXAI
 N. Plainfield, WEAM
 Paterson, WBAE

New Mexico:
 Roswell, KNJ
 State College, KOB

New York:
 Albany, WJN
 Buffalo, WGR, WWT
 Canton, WCAD
 Elmira, WBAE
 Newburgh, WCAE
 New York, KDOW, WBAE,
 WJAM, WDT, WVP,
 WJZ
 Poughkeepsie, WFAE
 Rochester, WHQ
 Ridgewood, WHN
 Schenectady, WGY, WRL
 Syracuse, WBAE, WDAI,
 WFAE
 Tarrytown, WRW
 Utica, WBL
 Watertown, WFAE

North Carolina:
 Asheville, WFAJ
 Charlotte, WBT

North Dakota:
 Fargo, WDAY

Ohio:
 Akron, WOE
 Athens, WAAV
 Canton, WVE
 Cincinnati, WAAD, WIZ,
 WLV, WMH
 Cleveland, WBEK
 Toledo, WEAJ, WEAQ
 Dayton, WAJ, WFO
 Defiance, WCAQ
 Fairfield, WL-2
 Granville, WTD
 Hamilton, WBAU, WRK
 Lebanon, WPG
 Marietta, WBAV
 Portsmouth, WDAE
 Toledo, WBAJ, WHU,
 WJK
 Youngstown, WAAJ, WMC
 Zanesville, WPL

Oklahoma:
 Muskogee, WDAV
 Oklahoma City, WKY,
 WFT

Texas:
 Tulsa, WEH

State, City, Call
 Eugene, KDZJ
 Hood River, KQP
 Klamath Falls, KDYU
 Portland, KDQJ, KPAB,
 KGG, KGN, KGW, KQY,
 KXG

Oregon:
 Eugene, KDZJ
 Hood River, KQP
 Klamath Falls, KDYU
 Portland, KDQJ, KPAB,
 KGG, KGN, KGW, KQY,
 KXG

Pennsylvania:
 Bridgeport, BRAG
 Brownsville, WDAQ
 Clearfield, WPI
 Erie, WJT, WSK
 Harrisburg, WBAK
 McKeesport, WIK
 Philadelphia, WCAU,
 WDAK, WFI, WGL,
 WIP, WOO, WPI
 Pittsburgh, KDKA, KGV,
 WAA, WCAE, WFB
 Villanova, WCAE
 Wilkes-Barre, WBAK

Rhode Island:
 Edgewood, WEAG
 Pawtucket, 10J, IXAD
 Providence, WEAN

South Dakota:
 Rapid City, WCAT
 Sioux Falls, WFAT

Tennessee:
 Memphis, WKN, WPO
 Nashville, WDAE

Texas:
 Amarillo, WDAG
 Austin, WCM
 Dallas, WDAO, WFAA,
 WLB, WLB
 El Paso, WDAK
 Fort Worth, WBAE, WPA
 Houston, WCAK, WBAE,
 WJL, WJL, WJL, WJL
 Paris, WPK
 Port Arthur, WCAH
 San Antonio, WCAR

Utah:
 Ogden, KDZL
 Salt Lake City, KDYL,
 KDVZ, KZN

Vermont:
 Burlington, WCAX

Virginia:
 Norfolk, WSN
 Richmond, WBAZ

Washington:
 Aberdeen, KNT
 Bellingham, KDZR
 Centralia, KDZM
 Everett, KDZZ
 Lacey, KGY
 Seattle, KDZE, KFC, KHQ,
 KJR, KTW, KZC
 Spokane, KFZ, KOE
 Tacoma, KGB, KMO
 Wenatchee, KDZJ, KZV
 Yakima, KPY, KPT

West Virginia:
 Charleston, WAAO
 Huntington, WAAR
 Morgantown, WHD

Wisconsin:
 Milwaukee, WAAK, WCAJ
 Madison, WHA

Hawaii:
 Honolulu, KDYX, KGU

Canada:
 Calgary, CHBC, CHCQ,
 CFAC
 Edmonton, CJCA
 Fort Frances, CFPF
 Halifax, CFHD
 Hamilton, CKOC
 London, CJKG
 Montreal, CFCF, CHYC,
 CJBK, CKAC
 Ottawa, CHXK
 Regina, CKCK
 St. John, CJCB
 Toronto, CFCA, CHBC,
 CHCZ, CHVC, CJCD,
 CJCN, CJSC, CKPC
 Vancouver, CFCF, CFYC,
 CHCA, CJCE, CKCD
 Winnipeg, CHCF, CJCG,
 CJNC, CKZC

WHA-900-J. B. Dusk, Worcester, Mass.
WHB-200-D. Keigley, Miami, Okla.
WHQ-725-H. Walrath, Cedar Rapids, Ia.
WJH-1,000-R. O. Wise, Villisca, Ia.
WJX-650-R. M. Sanford, Atlanta, Ga.
WJZ-1,200-N. H. Schensted, Broton, Minn.
WKN-450-A. N. Hopkins, Ashtabula, O.
WKY-725-W. A. Knight, Hudson, Mass.
WLB-850-Wm. Davis Jr., Canon City, Colo.
WLK-500-W. P. Liller, Keyser, W. Va.
WLV-500-Wm. Hoggland, Brookline, Mass.
WMB-725-W. A. Knight, Hudson, Mass.
WOH-970-M. Simmons, Shreveport, La.
WOI-500-A. E. Strong, Flagler, Colo.
WOK-700-F. D. Weeks, Milwaukee, Wis.
WOQ-1,100-G. W. Perkins, Thomson, N. Y.
WOR-310-H. S. Rahiser, Pittsburgh, Pa.
WOU-475-A. Galloway, Grand Rapids, Mich.
WRK-600-R. O. Wise, Villisca, Ia.
WRR-700-H. Walrath, Cedar Rapids, Ia.
WRW-1,250-K. E. Gabbert, Clay Center, Kan.
WSB-1,800-S. S. 'Betty B.' Canal Zone.
WSY-570-M. Simmons, Shreveport, La.
WVJ-2,200-F. W. Hill, Cristobal, C. Z.
WWZ-215-H. S. Rahiser, Pittsburgh, Pa.
XXJ-900-H. Walrath, Cedar Rapids, Ia.

Bremer-Tully RADIO EQUIPMENT
 is the result of 12 years' experience in building precision appliances designed to satisfy exacting users.
 Our VERNIER CONDENSERS will eliminate interference and DOUBLE THE RANGE of your receiving set.
 Those of the radio public who have learned to demand results will accept no others.
 ASK YOUR DEALER, or order direct from the manufacturers
BREMER-TULLY RADIO CO.
 Telephone Harrison 2964-6658
 532 South Canal Street, Chicago

BRACH VACUUM LIGHTNING ARRESTER
 Every lightning flash fills the air with static, which has in it potential dangers to every radio and home, unless they are protected by the BRACH Vacuum Lightning Arrester.
 This unflinching sentinel is on guard day and night—it works automatically, does not have to be switched and cannot become grounded.
 Railroads, fire alarm systems and the U. S. Army depend upon the BRACH Arrester—successfully used for 16 years.
 Centering his objection around sections of the rules which interpreted mean that should a fire break out in a house where there is a Radio set which hasn't been inspected by agents of the underwriters, fire insurance could not be collected, it was pointed out that the ordinary Radio receiving set involves about as much fire hazard as a white enamel bath tub. The underwriters admit that antennas installed wholly inside of buildings represent no fire hazard.
 Sold by Dealers Everywhere
L.S. BRACH MFG. CO.
 NEWARK, N. J.

Fire Underwriter's Rules Said Narrow
 Radio Set in House Claimed No More Dangerous Than Familiar Bath Tub
 (Special to RADIO DIGEST)
 WASHINGTON—Protesting against the proposed Radio installation rules prepared by the electrical committee of the National Fire Protection Association, made public recently, F. W. Brown, executive officer of the American Radio Association, with national headquarters here, in a letter to W. S. Boyd, chairman of the electrical committee, pointed out that such rules tend to interfere with the progress of Radio.
 Centering his objection around sections of the rules which interpreted mean that should a fire break out in a house where there is a Radio set which hasn't been inspected by agents of the underwriters, fire insurance could not be collected, it was pointed out that the ordinary Radio receiving set involves about as much fire hazard as a white enamel bath tub. The underwriters admit that antennas installed wholly inside of buildings represent no fire hazard.

RECEIVING RECORDS? WATCH 'EM GROW—
 THE race continues! Amateurs who are able to beat the records listed below, or who can claim distance receiving records (100 miles or better) for stations not listed below, but which are given in the broadcasting directory, need only send in their records to be listed along with their names.
 One condition exists. Every record aspirant MUST GIVE the NUMBER OF MILES represented by the record, if his letter is to be considered. Otherwise it will be thrown out.
 Records to date are given below.
 —Broadcast Editor.

Station, Miles Record, and By Whom Heard.
 AG1-720-R. C. Bryant, Clarkston, Wash.
 DD5-1,265-C. D. Mason, Cleveland, O.
 KDAF-560-S. W. Wilkinson, Knoxville, Tenn.
 KDKA-1,150-D. Keigley, Miami, Okla.
 KDN-720-D. Lombard, Malden, Wash.
 KDOW-1,700-W. A. Knight, Hudson, Mass.
 KDYQ-2,250-C. M. Rice Jr., Worcester, Mass.
 KDYQ-2,250-C. M. Rice Jr., Worcester, Mass.
 KFC-380-GBNG-Watsonville, Calif.
 KFU-760-D. Lombard, Malden, Wash.
 KFU-150-E. Thornton, Walla Walla, Wash.
 (Continued on page 9)
 KGB-250-D. Lombard, Malden, Wash.
 KGY-265-D. Lombard, Malden, Wash.
 KHQ-2,400-C. M. Rice Jr., Worcester, Mass.
 KJH-70-R. C. Bryant, Clarkston, Wash.
 KJR-290-D. Lombard, Malden, Wash.
 KLP-1,300-H. Wantuck, Fayetteville, Ark.

KLZ-1,575-C. M. Rice Jr., Worcester, Mass.
 KNJ-1,150-N. M. Holmes, Chippewa Lake, O.
 KOB-1,550-C. M. Rice Jr., Worcester, Mass.
 KQW-1,725-W. E. Long, Sterling, Ill.
 KUO-3,000-C. M. Rice Jr., Worcester, Mass.
 KVQ-650-R. C. Bryant, Clarkston, Wash.
 KZM-700-D. Lombard, Malden, Wash.
 KYG-310-R. C. Bryant, Clarkston, Wash.
 KYJ-1,300-H. Wantuck, Fayetteville, Ark.
 KYW-1,000-Wm. Holland, Brookline, Mass.
 KZM-700-D. Lombard, Malden, Wash.
 KZN-1,875-C. M. Rice Jr., Worcester, Mass.
 KZY-2,600-A. Galloway Jr., Grand Rapids, Mich.
 WAAE-450-R. M. Sanford, Atlanta, Ga.
 WAAF-425-S. W. Wilkinson, Knoxville, Tenn.
 WAAK-900-C. M. Rice Jr., Worcester, Mass.
 WAAZ-325-F. W. Steffen, Hartley, Ia.
 WAH-175-D. Keigley, Miami, Okla.
 WBAH-400-C. D. Dancer, Chicago, Ill.
 WBAK-750-H. Walrath, Cedar Rapids, Ia.
 WBAX-800-C. D. Dancer, Chicago, Ill.
 WBU-800-W. A. Knight, Hudson, Mass.
 WBZ-1,175-R. O. Wise, Villisca, Ia.
 WCAC-550-N. G. Garlick, Galena, Ill.
 WCAK-685-S. W. Wilkinson, Knoxville, Tenn.
 WCM-1,500-C. M. Rice Jr., Worcester, Mass.
 WCN-1,000-W. Lerne, Elkhart, Ind.
 WCX-500-E. Waste, Spooner, Wis.
 WDAE-350-F. W. Steffen, Hartley, Ia.
 WDAF-750-H. A. Tuttle, Diamond, O.
 WDF-1,000-F. D. Weeks, Milwaukee, Wis.
 WDH-130-D. Keigley, Miami, Okla.
 WDI-2,000-Wm. Holland, Brookline, Mass.
 WDE-450-H. Walrath, Cedar Rapids, Ia.
 WDF-425-H. Walrath, Cedar Rapids, Ia.
 WDF-635-C. D. Dancer, Chicago, Ill.
 WGI-1,000-H. Walrath, Cedar Rapids, Ia.
 WGL-1,250-T. E. Jones, Berks, Okla.
 WGY-1,500-R. E. Baverle, Spring Valley, Minn.

LIGHT CLEAR STRONG TONE



Head Federal Phones
 THEIR ability to reproduce perfectly the voices and musical tones from broadcasting have made Federal Head Telephones
EXTREMELY POPULAR
 These Phones are durably constructed and are light in weight. Each set is carefully matched in tone.
 Demand the Genuine Federal from Your Dealer
 ACCEPT NO SUBSTITUTE
Federal Telephone and Telegraph Company
 BUFFALO, NEW YORK
 CHICAGO OFFICE: 805 STEGER BUILDING

Radio Digest

Illustrated

TRADE-MARK

E. C. RAYNER, Publisher
123 WEST MADISON STREET
TELEPHONE STATE 4844-4845
CHICAGO, ILLINOIS

New York Office
Detroit Office

2126 Broadway
28 Rowland Building

PUBLISHED WEEKLY

Subscription Rates
Yearly.....\$5.00 | Foreign.....\$6.00
Single Copies, 10 Cents

Entered as second-class matter April 27, 1922, at the post office at Chicago, Illinois, under the Act of March 3, 1879.

In a new scientific field where many writers are contributing articles there will arise some controversy over the expressions of opinions and statements made from time to time. Some of these controversies may be taken into the courts for settlement. The priority of inventions may be claimed as well as the merits of some part entering into the construction of the radio apparatus. The Radio Digest is an outlet for these expressions and the publisher disclaims any responsibility for opinions or statements made in connection with radio apparatus. The news will be printed as it comes to us.

Vol. 1 Chicago, Saturday, July 1, 1923 No. 12

Industry's New Doctors

Big Things Must Have Wise Leaders

IT HAS not been so very long since Judge Kenesaw Mountain Landis stepped in as supreme arbiter of the baseball game. Landis has done much to keep the game clean in the minds of the fans. The moving picture business was entering the same great problem when Will H. Hayes was appointed to a similar position. But only recently has Franklin D. Roosevelt been appointed to take charge of the affairs of the builders of the nation. Roosevelt will begin his active duties soon. Now comes the Radio situation which is not unlike either one of the others. The person will, in all probability, be Herbert Hoover. This makes four of the nation's big industries headed by well known men who have done great things in the past.

Broadcasters Should Repeat Calls

Repetition Will Aid Long Distance

NOT EVERYONE owning a receiving set is able to pick up the message when it starts, therefore he does not know who is speaking, singing or from what station the song or message is being broadcast. And again at the close, the station may have faded out.

It is best for those doing the broadcasting at the station to repeat their call and owner's name slowly and distinctly at every break in their programs so that amateurs hearing them from long distances will be able to know the station and who they are hearing.

A number of letters in this regard have been received by RADIO DIGEST complaining about the trouble. Perhaps it would be wise to repeat the call in the same manner as in sending a telegram, as "K for King, Y for Yale and W for Western," for K Y W. The latter is particularly necessary for calls containing a number of letters with similar sounds, as WBDE.

The Underwriter's Philosophy

Radio Equipment and Fire Insurance Regulation

IF YOU would take a look from the window of the RADIO DIGEST'S offices you would see six steel flag poles extending high on the roof of one of Chicago's large department stores. These poles penetrate the air high enough to attract any streaks of lightning in a storm, but they are never struck. Take another look and you will see an aerial attached to a pair of these poles below half mast. The flag poles are not given a single thought by the inspection authorities of the Underwriters, yet the wires are given drastic rules. There is not a thought given to the vent pipe extending on the roof of a house which is a part of the system and become a ground direct with the bath tub and soil basin. This is almost an exact circuit like a radio set. If there is a little "juice" in the wires then it becomes a hazard, so says the Underwriters.

The rules set down by the Underwriters have been formulated by persons entirely void of Radio knowledge it would seem, and the rules work a hardship for those most interested in the science of Radio.

If the Underwriters are to be a real source of service to the country, why not employ expert authorities in their respective lines to act in the interests of all concerned. There is really no need for rules on Radio, for lightning seldom ever strikes any extension in the air. It will strike something nearer the ground and usually hits an old dry wooden post or dead tree before it will come in contact with anything of steel or copper.

The whole theory of lightning and electrostatic charges combats the antiquated rules set forth by the Underwriters.

From Those Who Are Helping Radio

Boosters for Airphones Shown in Editorials

RADIO is a complete success, but it has not reached its highest efficiency. However, the amateur element is surely working fast and we may expect most anything daily. In the start of a new industry there are a few howlers, and gloom spreaders in every locality. A nice little comment comes from the editor of the Courier (New Haven, Conn.) in this manner:

"No, Radio isn't all a success just yet. Neither was the automobile, the phonograph or the motion picture. But the scientists are getting there just the same.

"It will be quite a while before the Radio enthusiast who has just bought his brand new crystal set or vacuum tube receiving set will know what's wrong when some night his outfit refuses to 'listen in' on the broadcasting station programs.

"As it is today there is always something that goes wrong no matter how well the set is constructed or how much money has been paid for it. The first thing that strikes the Radio fan is to roast the tar out of his pet little set without considering outside factors. He does not seem to realize that there are always elements beyond control at work in his vicinity or in the territory in which the broadcasting is done.

"For instance, leaky electric light lines make a noise like a spark set holding down the key and frequently prevent Radio folks in a whole community from hearing concerts, night after night. Then again elevators, X-ray machines, welding machines—dozens of such devices—make a horrible clatter in the air and inspire Radiocists to insert new slang expressions into the unofficial dictionary of 'cuss.'"

All new machines and devices must go through the critical stage, and those that travel the fastest and grow rapidly receive the most severe criticisms. Those who do the criticizing are not the ones connected with the editorial lines. The editor of the Sentinel (Et. Wayne, Ind.) makes this statement:

"The Radiophone is not to be condemned because of the probability of an accident, any more than swimming, boating, automobiling, hunting, or any other pastimes favored by the young and old alike. The new recreation is too rich in harmless amusements and useful instruction to be discredited by its avoidable dangers."

There has been a great deal said about making use of Radio to aid the police in catching criminals. Many a hurry call can be made by broadcasting news of a crime, and there may be a time when the criminal's picture can be sent quickly as is now done by the Belin system in Paris. If so the crook may be caught quickly. The editor of the Tribune (Kokomo, Ind.) writes of Radio in connection with the police department as follows:

"With crooks availing themselves of modern inventions to evade the scrutiny and escape the pursuit of the agents of the law, it sometimes seems a question whether it will be possible for the 'cops' to equip themselves so as to be able to cope with the crooks.

"Since the high power automobile became a dependable vehicle, it has been the favorite means of the bank robber, the highwayman, the payroll snatcher and the metropolitan murderer in getting quickly away from the scene of the crime.

"Despite the fact of the use of these inventions by the crooks, however, the law seems in a fair way to get ahead and keep ahead. The Radio is the thing that is giving the advantage to the cops. Throughout the country police stations are installing broadcasting stations and receiving sets. As soon as such equipment becomes general, and that time is not far in the future, every criminal will be advertised to the world as soon as his crime is committed. He has often been able to make his getaway, because of the time and expense of sending descriptive messages by telephone and telegraph. He will be in a much tighter place when the Radio gets into operation after him. When the description of a criminal is transmitted by Radio its broadcasting will come to the notice of police officials and other persons listening in all over the country, and they will get the description so accurately that they will likely know the culprit at sight."

The ones most appreciative of the Radiophone are those who live in the smaller towns and the country. Here is where a great populace has plenty of time on their hands evenings, and because they do not have the chance to hear the best of music they will use their receiving sets to pick up the messages in the air. The editor of the Recorder (Lyons, Colo.) writes of what small town inhabitants are doing:

"Listening in' on a country telephone may have had its thrills in by-gone days, but the 'listening in' on the conversation of the world by the half million of owners of Radio receiving sets have an interest which comes not from a neighborhood gossip, but from getting up-to-minute reports of ball games, music and the latest news. You may hear a trombone in Chicago, and the next day may be a brass band in Salt Lake City, or a cornet in the Times-office, Denver, all of which is broadcast every few hours and can be picked up by any amateur having a proper receiving set. It is certainly wonderful."

The legislating element in municipalities and states seems to think it has the authority to regulate Radio communication. As a matter of fact that regulation belongs to the Federal government. A special committee from the National Fire Protection association has drawn up rules and the special agent for the Underwriters' Laboratories has asked that all Radio users try them out, then make suggestions. The proposed ordinance in Chicago would compel owners of Radio receiving sets to procure permits for their operation and pay a license and inspector's fee. More soft jobs for high salaried 'experts.'

RADIO INDI-GEST

Meters, Gas, Electric or Taximeters

Question.—I have a tuning coil, crystal detector, fixed condenser and a head set wound to three thousand ohms. How many meters can I hear?

Answer.—We do not know whether you mean gas, electric, water or taximeters. The hardest part is not in hearing or even reading them, it's the paying that's most difficult!

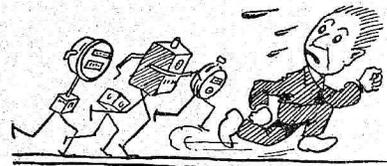

Your Voice Heard Before You Speak

"We have spring vegetables at Christmas, the women wear furs in summer, we get Sunday papers Saturday night, we make twenty-year-old whisky in twenty minutes; a man called on the telephone in San Francisco from New York hears our voice hours before we speak." Thank goodness to-day is still the yesterday of to-morrow.—Chicago Daily News.

Wanted—School to Teach Aerials

Clipping from Springfield, Illinois State Register says, "weighted to keep the aerial taught." We thought they had quit teaching aerials now-a-days, and were only "stringing" them.

"Spring Is Come and Gone"

Even the poets are getting the radio bug, as witness the following by Charles Irving Corwin:

The hairless dog from Mexico
Enjoyed his day some years ago,
The fireless cooker—not the kind
Of flesh and blood that's hard to find;
But one that has been subjugated—
Not insulanted but insulated.
It has its days both off and on,
And now it is persona non.

The trackless trolley ran awhile,
And now it, too, is out of style,
Some deathless lines too often quoted,
Today are hardly even noted.
The ruthless warfare of the Hun
Has spent der tag and now is done,
The flapper who is skitless—nearly
(Well, one can see her finish clearly).
Of all these less's here's the greatest—
The wireless phone and it's the latest;
It needs no girl to snap "line's busy!"
To roll her r's until one's dizzy;
Nor say in dulcet tones, "wrong number!"
And then return to wakeless slumber.

Dough Talks—by Airphone

Radio messages from New York, San Francisco, and other distant points, controlled the electrical baking apparatus with which a loaf of bread was baked at the Muncie, Ind., food show last week. Even dough talks by Radio today.

All Easy But the Eight Dollars

Little Joe had just completed a crystal receiving set and was proudly exhibiting it to his mother. "Wasn't it very hard to do all this?" she said.

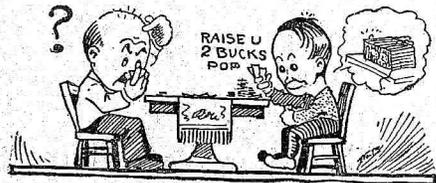

"Naw," said Joe, "most of it was as easy as anything." "What was the hardest part of it?" she asked. "Getting the eight plunks out of pa to buy the stuff."—Detroit News.

Radio Ma Goose

Little Jack Horner sat in his corner
Tuning his crystal set;
His dad came along and fell for it strong;
He's home every night now, you bet!

Wrigley Ads Might "Gun" It More

A meeting of representatives of stations within 360 meters of New York and New Jersey has been called to prevent radio "jam" in the air. Some of the sweet things that come through must have gummed up the ether.—Tacoma Daily Ledger.

The Plain English of Ether and Ether Waves

By *Latson Balliet*

HAVING explained something of our yet limited knowledge of ether waves in the preceding paragraphs, we are now down to the question of "tuning in" for the vibrations we want, and "tuning out" the discords we do not want to receive.

If you will stretch a wire across a room, running one end through a screw-eye and attaching a heavy weight to the end, thus drawing it taut, you may try an interesting experiment on tuning.

Go to a piano in the same room, and strike the keys one after another until you find one that will make the wire vibrate. Of all the keys on the piano only one note will make the wire vibrate, and if you listen carefully you will find that the wire gives off the same note that is given off by the piano string.

Tightness Determines Tune.

Now add more weight to the wire, increasing the tension, and you will find that the wire will not vibrate when the same note is struck, but that it will again vibrate in unison with another string of the piano, higher up the scale. If the weight is reduced a note lower down the scale will set up the vibration in the wire. If you have a turnbuckle or set-screw in your wire line, you can very likely tune that wire through several octaves of your piano scale, by increasing the tension. The piano tuner can tune you to hear the pitch you desire. When one string on your piano becomes "out of tune" it has become just a little less tight, and sends out the wrong number of vibrations per second.

Thus in your experiment you have a wireless transmission of a sound wave from the piano to the wire. If you move two pianos into the same room, and tune

them with each string in exact unison with the same string of the other and listen carefully you will find that one piano without a player will give off the same music that is being played on the other. Thus you can have a miniature example of a Radio concert, demonstrating with air waves instead of ether waves.

Radiation of Sound Waves.

The explanation is simple. When the piano key is struck, the piano string sends out sound waves in the air—radiating in all directions from the string. If the note is high pitched, there are a large number of vibrations per second, and if the note is a deep bass note there are fewer sound waves per second. As explained in the preceding paragraphs, the high pitched note may have 800 vibrations per second, and the low bass note may have but 200 vibrations per second. It is known that sound travels in air waves at the rate of 1200 feet per second, therefore if there are 800 vibrations in 1200 feet of air the wave length would be one and one-half feet, while with the bass note the wave length would be six feet.

With this in mind "tuning in" for wave length becomes easily understood. Naturally all other wave lengths are "tuned out." It is obvious that a wire stretched between the two pianos would not detect a single vibration, unless it was tuned to the pitch of some one note, in which event, that one note could be heard several blocks away over a telephone connected with the wire, and every other note would be excluded. Another wire tuned for another note, connected with another telephone would hear only the note it was tuned to catch. If, however, there was an orchestra playing in the room every note of that same pitch would have the

same number of vibrations a second, and would be heard as a jumble of discord, while all other notes would be excluded.

Comparison to Radio Waves.

The foregoing illustrates very clearly the principles on which Radio works, though there is some important difference between sound waves and Radio waves. Sound waves are motions of the air created by vibrations of different things. Radio waves are vibrations of the "ether" that fills all space and are created by the vibrations of electric currents. The sound waves in the air make the sensitive eardrum vibrate and can be "heard." Radio waves are not vibrations of the air, and cannot be heard until some device has been installed to change the ether waves to air waves. We can word it differently, and say to change the electric waves in the ether to mechanical waves in the air, and thus we actually hear electricity by transforming its pulsations to the eardrum.

The most commonly used instrument is the telephone. You can talk over the telephone, and send the vibrations of your voice for many miles over the wire. A singer in New York can be heard in an auditorium in San Francisco, with the aid of a loud speaking apparatus and a horn, but linemen out along the wire can hear nothing. There are no sound waves, except at the sending and receiving ends. The electric waves between are not sound waves whether on the wire or in the ether, but any number of receiving sets or listening-in sets can be set up, in which event the singer can be heard any place along the line.

Wires do Nothing Without Apparatus.

It will seem something like mystery to call attention to the fact that you

can chop the ice from ice-covered electric wires and by connecting a furnace resistance to the wire, obtain enough heat to melt platinum, steel or any known metal. You can connect a telephone to the silent wires of a telephone circuit and hear a concert miles away. You can take a brilliant light from black wires in the darkest place and yet the heat waves in the furnace come through the cold, the sound waves come through noiselessly, and the light waves come through the dark. You make heat where you want it, light where you want it, and sound where you want it. Neither heat, light nor sound waves exert any of their properties until they are resisted or interrupted. Hence the space between here and the sun is absolutely dark, silent and cold, though literally filled with uninterrupted light, sound and heat waves.

All we have to do is to stop them, transform them into whatever form we wish to use them and after using them to let them go on either in their original condition or in the transformed condition. The sending, receiving, transforming and amplifying apparatus are today manufactured by a large number of firms and under many patents. New patents for extended utilities of the principle, and improvements are being taken out daily, but with the foregoing explanation of the elementary principles, you will be prepared to better understand the operations of the apparatus as described in catalogs of firms manufacturing or selling them.

Editor's Note—The fourth of Mr. Balliet's everyday language explanations of the wonders of Radio will appear in the July 8 issue of RADIO DIGEST.

Construction of an Inductance or Tuning Coil

Simply Made Tuner Mounted On Panel

There are six distinct items in connection with the construction of a simple receiving set. An inductance or tuning coil, a crystal rectifier or mineral detector, high resistance telephone receiver, fixed condenser, antenna and the ground.

The tuning coil is used to tune in the station you desire to receive. The crystal detector rectifies the electro-magnetic wave carrying voice or telegraph signals to the telephone receiver. The high resistance telephone receiver enables you to hear the weak current rectified by the detector. The condenser stores up the weak currents and then discharges them in groups through the telephone receiver. The antenna is suspended in the air and insulated from all surrounding objects. It is a part of the electrical system by which the electro-magnetic waves are sent or received. The ground may be a wire buried in the earth, or a water pipe, which is, of course, connected to mains buried in the earth. This completes the radio circuit.

Materials for Making Coil

In making an outfit the first essential is the tuning inductance or tuning coil. One of these coils can be made by the average amateur and will give good results if constructed as follows:

The materials for making the coil consist of one cardboard tube 6 inches long, 3 inches in diameter and the walls 1/6 inch thick; six ounces of No. 20 or 22 single silk covered copper wire; one 1 1/2 inch Radio switch lever with a hard rubber knob; twelve switch points; one wood case 6 1/2 inches long, 4 inches wide and 3/4 inch thick; one sheet of bakelite 6 1/2 inches long, 4 1/4 inches wide and 1/8 inch thick. This piece is drilled as shown in the illustration.

How to Start the Work

First give the cardboard tube a good coat of shellac and set it aside to dry. When thoroughly dry make a small hole 3/8 inch from either end with a darning needle. The end of the wire is passed through these holes at the start and after the coil is wound, and a knot tied in each end on the inside against the tube, allowing about one foot to protrude for making connections. Wind on eight turns of the wire and then scrape off a small amount of the insulation and make your connection tap. Use about six feet of the wire to make tap wire lengths. The six foot piece is cut into eleven equal lengths. Make sure that all connections from the coil to the taps are well made and tight, soldered and taped. Take the taps off at the 12th, 15th, 20th, 24th, 40th, 64th, 100th and the last turn.

Finishing and Mounting

When this work is complete apply shellac to the windings to keep them in place

WORKING DRAWINGS FOR COIL

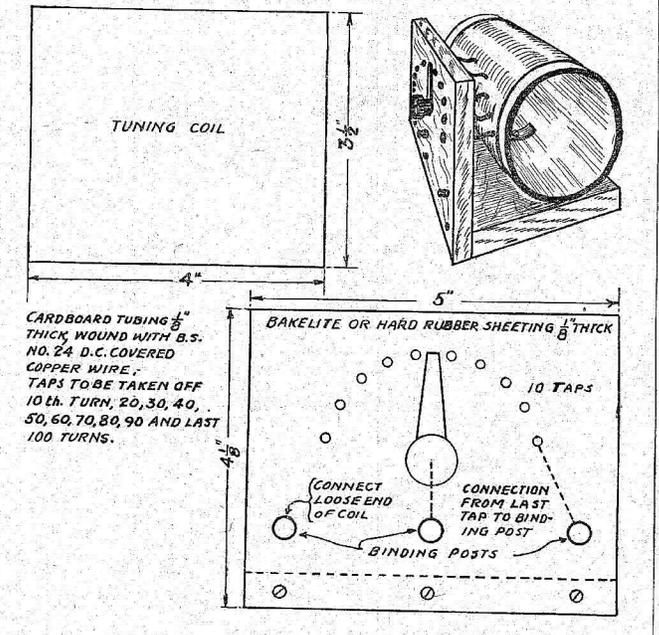

and at the same time help to keep the moisture out, thus warding off grounds. The hard rubber or bakelite sheeting is drilled to take the switch points, binding post and switch lever, as shown in the illustration. Three holes are also drilled to take 1/4 inch wood screws, as shown, to secure the bakelite front. Connect and solder the taps, starting from the left. Secure the coil to the base with a fiber strip and make connections as shown.

How to Store Away Cells

If it becomes necessary for any reason to dismantle and store your receiving outfit there is only one thing that requires much attention and that is the batteries, for, unlike the rest of the set, idleness proves detrimental. There are several ways of preparing the battery for storage.

One is by discharging the battery at the regular five-hour rate. The acid should then be drawn off and stored in a glass container (not a metal container). Separators should then be removed and stored separately. When it is desired to put the battery in use again it should be treated as a new one and given the usual long first charge.

Another way is to recharge the battery fully before retiring it for the time being. A point to remember is that if at any time the battery is to remain idle during the winter months and is likely to be subjected to any degree of cold it is best to overcharge it, so as to avoid possibility of freezing, which would damage the battery beyond repair. The freezing point of an overcharged battery is in the neighborhood of 43 degrees below zero, which precludes the possibility of freezing in most part of the United States.

Socket Aerial Works Well on Light Wires

Many amateurs are using both socket and outdoor aerial, disconnecting the socket aerial and plugging in on the outdoor antenna circuit when they wish to receive short-wave signals.

The socket aerial is made as follows: The material needed should first be assembled. This includes one attachment plug, such as electricians use for a fan or table lamp, three pieces of tinfoil three inches square, four pieces of mica four inches square or eight pieces of varnished cambric four inches square, and two pieces of sheet fiber six inches square and one-quarter of an inch thick.

Bore a hole one-quarter of an inch in diameter in one corner of each piece of fiber, about one-half inch from either edge. Then take twelve inches of ordinary lamp cord and attach one pair of ends to the attachment plug in the regular way. The other pair of ends should be connected to the two pieces of fiber by running either wire through the one-quarter-inch hole and tying it in a knot. Be sure to leave an end of about three inches beyond the knot.

Next, fasten the corner of one piece of tinfoil to one wire and another piece to the second wire. You now have one piece of tinfoil left. This should have a piece of lamp cord twelve inches long attached to one corner of it; now, place a sheet of mica or two pieces of varnished cambric between each layer of tinfoil. Then clamp the whole between the two pieces of fiber. If this cannot be obtained, use two pieces of dry pine board one-half inch thick. In clamping the sheets of mica and tinfoil together, caution must be taken not to let any of them slip and to prevent any of the sheets of tinfoil from touching one another.

There is one loose wire now left hanging when the plug is screwed into a lamp socket. This end should be secured to a binding post at one of the bottom corners of the fiber plates, and this is the point at which the aerial connection to the receiving set is made.

Connector Makes Phone Jack

Bore a hole in the cabinet to take the socket part of a line connector used on the dash of an automobile. When this is in place and connected up it is an easy

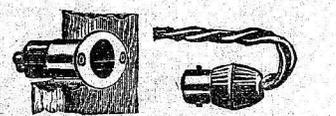

matter to attach the phone line with the other part of the fitting. The automobile line connectors can be purchased from a ten cent store or from an automobile supply house.—George Blanton.

Radio Telephony for Amateurs and Beginners

Part VI—Section II: Vacuum Tube Detectors

By Peter J. M. Clute

To Explain—

The following article by Peter J. M. Clute is a continuation of his series. Articles to come are:

- VII. The Batteries.
- VIII. Receivers and Loud Speakers.
- IX. Crystal Detector Receiving Sets.
- X. Vacuum Tube Receiving Sets.
- XI. Amplifiers.
- XII. Useful Information.

OUR PREVIOUS discussion considered detectors of the crystal type capable of signal reception over only extremely short distances. With a vacuum tube detector signals may be received at distances up to ninety miles, depending upon atmospheric conditions, contour of intervening territory and energy of the transmitting station. A typical tube is shown in Figure 1. The vacuum tube has more sensitive and more stable characteristics than the crystal detector and has the advantage in the matter of louder signals, increased range and better adjustment. Figure 2 shows a socket, adapted for mounting any standard four-prong tube.

Before taking up the construction and operation of the vacuum tube it will be advisable to consider briefly the subject of electric charges. All matter is believed to be made up of electric charges, of which there are two kinds, namely, positive and negative. Like electric charges repel, while unlike charges attract each other. According to the elec-



Fig. 1

tron theory, an atom of matter is composed of a positively-charged nucleus, surrounded by smaller negatively-charged electrons, the number of which is determined by their ability to keep the system in a stable or neutral condition.

In its simplest form the vacuum tube, called a thermionic valve, consists of two metallic electrodes securely sealed in a glass bulb, which latter is then exhausted to a vacuum. One electrode, known as the "plate," is formed of sheet metal, while the other, called the "filament," is a fine wire loop having both ends brought out through and sealed in the glass. In order for the vacuum tube to act as a rectifier, it must permit the passage of the received high-frequency alternating current in one direction only. To meet this condition the resistance of the tube must be lowered when the current flows in one direction and it should be increased when the current tends to flow in the opposite direction.

Figure 3 shows a simple two-electrode vacuum tube detector hook-up. When

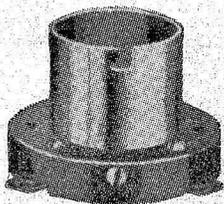

Fig. 2

heated to a temperature, which will cause it to glow brightly, the filament emits negative electrons. These negatively-charged electrons being thrown off from the filament, leave it with a positive charge. If the plate has a negative charge with reference to the filament, the

negatively-charged electrons will be repelled back to the filament. Under these conditions, no charges reach the plate, hence there will be no flow of current. A positive charge with respect to the filament, placed on the plate, will attract the negative electrons. There is thus created a passage of pulsating current from the filament to the plate.

The amount of current passing from filament to plate depends upon the temperature of the filament, the battery potential and the degree of vacuum in the bulb. Figure 4 illustrates one type of rheostat for varying the filament temperature by changes in the current. Increasing the filament temperature up to a certain point permits more current flow. Beyond that point the current will not increase unless the battery potential is raised. For any given filament temperature and battery voltage there is a definite limit to the current that will pass. The efficiency of the tube depends upon the degree of vacuum—a low vacuum causes the filament to burn out quickly.

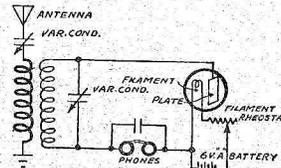

FIG. 3: TWO ELECTRODE VACUUM TUBE DETECTOR RECEIVING CIRCUIT

The sensitiveness of the thermionic, or vacuum, tube is greatly increased by the addition of a third electrode to the tube just described. This third element termed the "grid," is essentially a fine mesh metallic screen, interposed between the filament and plate, so that the electrons must pass through the grid in order to reach the plate.

Figure 5 shows a simple receiving circuit having a three-electrode vacuum tube. The function of the grid in the vacuum tube is to control, with a small amount of energy, the flow of current from filament to plate. With the filament properly heated and a positive charge on the plate, there occurs a passage of electrons to the plate. The use of any vacuum tube involves a storage battery termed the "A" battery for heating the filament as well as a high-voltage plate or "B" battery. The latter is connected in series with the telephone receivers, so that its positive terminal is next to the plate and its negative terminal is next to the filament. The "B" battery serves to pass current across the electronic path between filament and plate, provided the filament is heated. For most vacuum tubes, a 6-volt "A" battery is used drawing about 1 ampere of current. The "B" battery usually consists of special dry cells put up in compact units of 22½ volts each, although sometimes special storage-cell units are used. Current flow in the vacuum tube can



Fig. 4

be controlled by applying a small potential between the grid and filament. Any change in the grid immediately affects the electronic flow. When the grid is negatively charged, it has the effect of decreasing the current in the telephone circuit, and when there is a positive charge on the grid it allows the plate current to increase. Thus the slight energy of the incoming electro-magnetic waves can be applied to the grid and filament and used to control the flow of pulsating direct current from the "B" battery through the telephone receivers. The effect of the signal is thus multiplied through the relay action of the tube, producing louder and clearer sounds in the telephone receivers than could be obtained with a crystal detector, or by simple rectification as previously described.

With tubes designed for common usage, the sensitiveness of operation is greatly increased by inserting a small condenser in parallel with a high resistance in the grid circuit. The actual effect on the telephone is fundamentally the same as previously described, in that the current from the "B" battery rises and falls in proportion to the feeble impulses of the incoming signals. The character of

grid control depends directly upon the bias potential maintained upon the grid. The requisite bias potential for varied conditions of use may be obtained either by

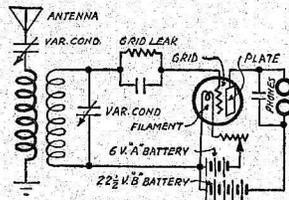

FIG. 5: THREE ELEMENT VACUUM TUBE DETECTOR RECEIVING CIRCUIT

tapping one terminal of the grid circuit from a fixed resistance in series with the filament rheostat, through which the filament current flows, or by employing a "grid leak" connected across the "grid condenser" or between the grid and the filament. A commercial type of grid leak unit and mounting is shown in Figure 6.

Experience has demonstrated that the use of the "grid leak" is the more practical method of controlling the grid potential of a vacuum tube. The function of the grid leak is to present a leakage path across the grid condenser so that the potential of the grid member in respect to a terminal of the filament may be maintained at some desired value. The potential maintained on the grid is computed by Ohm's law and it is, therefore, equal to the grid current times the grid resistance. The value of grid leak unit to be used for any particular amateur receiving set depends upon the design of the apparatus, the type of antenna and ground system, grid condenser and other factors. The value of grid condenser capacity generally used is 0.00025 microfarad, with a grid leak unit of 1 megohm (1,000,000 ohms). The best values to be employed vary somewhat with different tubes. If the grid leak resistance is too

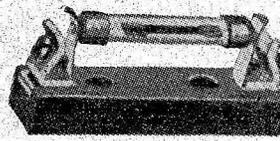

Fig. 6

high, leakage will take place slowly, causing a sputtering sound in the receivers. On the other hand, too low a resistance will cause too rapid a leakage and a weak signal will result. The negative grid potential cannot accumulate full value for each wave. Vacuum detector tubes usually operate best when the low side of the grid circuit is connected to the negative side of the filament.

The filament of most vacuum tubes requires about one ampere current at five volts at the terminals, a six-volt storage battery being used in order to supply the losses in the leads and the filament rheostat. If it is desired to adjust the filament by indicating instruments, it should be done by a voltmeter and not by an ammeter. All tungsten filaments show a decrease of current during their life and if constant current is, therefore, maintained in the filament rather than constant voltage across it, the life will be greatly decreased and no better signals obtained. The average life of a tube is variously given as 1,000 to 1,500 hours. If operated at constant current, they will last much longer. The normal voltage to be maintained at the filament terminals

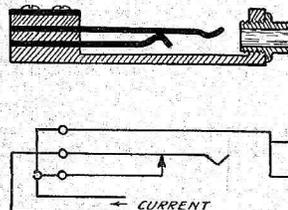

FIG. 7(a) TELEPHONE JACK FOR METER CONNECTIONS. (POINTS NORMALLY SHORT-CIRCUITED).

varies with the different makes of tubes, but it is safe to say that it lies in the range between 5 to 5.5 volts. It is desirable that any installation involving vacuum tubes should provide ammeters and

voltmeters of proper range for determining the values of the various direct currents and potentials. The values for best operating conditions and the limits which should not be exceeded are usually specified by the tube manufacturer.

Where meters are available it is expedient to obtain the characteristic curve of a tube in a set, so that in case a set is not operating normally this method may be of great use in locating the trouble. It is advisable to connect meters in circuit through a telephone jack and plug, so that the instruments may be short-circuited when not in use. Figure 7 (a) shows a jack with two points normally short-circuited and Figure 7 (b) the plug by which an instrument may be connected in circuit.

Vacuum tubes vary in the degree of vacuum or gas content and it is often desirable to know in which class they belong. For detector circuits, the "soft" or

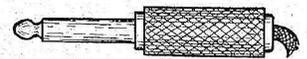

FIG. 7(b) PLUG FOR CONNECTING METERS IN JACK.

gas content vacuum tube is generally used. These tubes are very sensitive if they are properly adjusted. A careful adjustment of filament current and plate potential is essential for best results. Detector tubes operate at plate potentials of 18 to 22½ volts, variations being obtained from taps on the "B" or plate batteries.

The vacuum detector tube is far superior to the crystal detector in the matter of signal detection. In some circuits, the sensitiveness of the detector tube is so far ahead of the crystal detector as to render a comparison useless.

Oil Soaked Galena Aids Signals

Fans who find that their pet crystal detector is losing its sensitiveness might try soaking it in ordinary lubricating oil of a thin grade for a couple of days. After this, the signals should be much louder.

It will be noticed that if a galena crystal is laid on a piece of clean white paper and allowed to remain for any length of time, the paper will become oil marked. This naturally indicates that the galena in its make-up contains a certain amount of oil.

Aerial Loop Lead Stops Static

One way to reduce static is to make a loop lead to the aerial. Construct the aerial in the usual manner then make

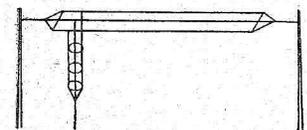

connections to each wire in the aerial and run them down as shown in the illustration. Keep the wires separate with rings of insulating material to hold them in a circular form. I have found this to reduce much of the static to be encountered during the warm weather.—Clifford Kenyon.

How to Care for the Crystal

Do not place your hands on the surface of a crystal to be used as a detector. The action of the crystal is a rectifying action and any foreign matter or grease from the hands will interfere with its rectifying action. A sensitive spot on a crystal does not last long and when signals begin to fade find a new sensitive spot on the crystal. Keep all your reserve tested crystals wrapped in paper and in tinfoil until ready for use. Handle the crystals with a small pair of tweezers.

The Terms Hard and Soft Tubes

The terms "hard" and "soft" used in describing different Radio tubes often puzzle the average Radio fan. Soft tubes are tubes in which a gas is substituted for the vacuum and are most often used in the detector circuit. The hard or high vacuum tubes are those in which there is an intense vacuum and are used as amplifiers most frequently.

Simple Instructions for the Beginner

By Harry J. Marx

Expanding the Regenerative Set

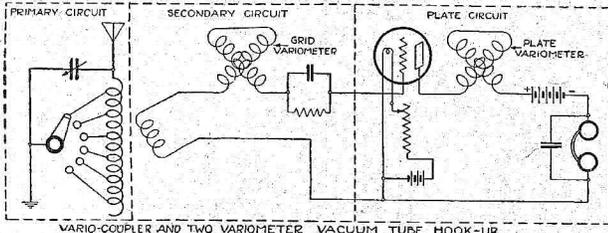

Figure 1

THE PUBLICITY of the receiving set using variocouplers and variometers is unquestioned. In increasing the range of this type of set, the amateur has considered both Radio and audio frequencies, and necessary expense, however, has limited the expansion to one step at a time. In the following article the progressive steps are analyzed for the benefit of the amateur in expanding his receiving units in any particular direction that he may contemplate.—Editor.

IN ISSUE number 1, of the RADIO DIGEST, April 29th, 1922, the popular variocoupler and two variometer vacuum tube hook-up was illustrated and explained. The amateur who started with this circuit no doubt is seriously considering the addition of one or more steps of amplification. The decision to be made is whether Radio or audio frequency is most advantageous in considering this step. There is one all-important factor to be taken into account, "Is it long distance or local Broadcasting that is of more importance to the operator?"

For local Broadcasting the Radio frequency alternating currents sent out by the Broadcasting Station are plenty strong enough for rectification by the detector tube. The Audio frequency stages are adequate enough to amplify the detector current.

When long distance reception is contemplated, it will be found that the Radio frequency currents are too weak for rectification by the detector tube, and for this reason it is necessary to first amplify the weak Radio frequency current, and then send it to the detector tube for rectification. The resulting tones will be found clear enough in the receivers. If further amplification is desired, a stage or two of audio frequency amplification can be added.

The Single Vacuum Tube Circuit

Figure 1 is the simple variocoupler and two variometer vacuum tube hook-up. The list of parts required follows:

1. Variocoupler.
2. Variometers.
- 3-43 plate variable condenser.
- 1 grid leak.
- 1 grid condenser.
- 1 detector vacuum tube.
- 1 filament rheostat.
- 1-6 volt "A" battery.
- 1-2 1/2 volt "B" battery.
- 1-.001 mfd. fixed condenser.
- 1 pair of receivers.

A possible addition is a 23-plate variable

condenser shunted across the secondary of the variocoupler.

Radio Frequency Amplification

The hook-up with this circuit is given in Figure 2. The numbers enclosed by the circles are for identification of parts which are listed as follows:

1. Antenna.
2. Ground.
3. Variocoupler.
4. 43 plate variable condenser.
5. 23 plate variable condenser.
6. Grid variometer.
7. Grid condenser.
8. Grid leak.
9. Detector vacuum tube.
10. Plate variometer.
11. 3 Filament rheostats.
12. 6 volt "A" battery.
13. .001 mfd. phone condenser.
14. Receivers.
15. 2 Amplifying vacuum tubes.
16. 60 volt "B" battery.
17. 2 Radio frequency transformers.

timely have a complete and efficient receiving station. He wants to feel satisfied that both local and long distance broadcasting are within his reach. The reception in both cases should be strong enough for the satisfactory operation and use of the loud speaker. After going through the three previous stages, he has the necessary equipment to assemble the set illustrated in Figure 4. The list of parts identified by the numerals is given as follows:

10. Plate variometer.
11. 5 Filament rheostats.
12. 2-6 volt "A" batteries.
13. .001 mfd. Phone condenser.
14. Receivers.
15. Four amplifier vacuum tubes.
16. Two 22 1/2 to 45 volt "B" batteries.
17. 60 volt "B" battery.
18. Two audio frequency transformers.
19. Two Radio frequency transformers.

All these parts are by no means immediately necessary. For example, the variometers can be omitted, the filament rheostats can be reduced to three in number, one to control the filaments of the two Radio frequency amplifier tubes, one for the two audio frequency amplifier tubes, and one for detector tube filament control. One "A" battery can be used, but the drain of the current required by 5 filaments will soon wear down the battery. For this reason and also because it keeps the Radio and audio frequency circuits distinctly separate, it is advisable to use two "A" batteries. The number and voltage of the "B" batteries can be varied by slight changes in the hook-up.

Panel Units a New Feature

STARTING with Issue No. 13, of July 8, the loose leaf page will be temporarily discontinued in order to introduce a new series of panel unit diagrams. These panel units can be made up as desired and when connected together in different arrangements, will make a complete receiving station, limited only by the decision of the amateur.

There will be tuning units, detector units, Radio frequency amplification units, and audio frequency amplification units. Different types of tuning units are given so that the amateurs can use the apparatus which he has in the present set.

This series has been designed to supply the popular demand from our readers who are anxious to build up their sets in unit style. Like the usual sectional system, they permit the connection of additional units. In this way the amateurs can start with the crystal detector and tuning unit which at the same time can be connected to a vacuum tube detector unit when desired. Afterward Radio frequency amplification units can be added and likewise audio frequency amplification without changing the previous units.

Audio Frequency Amplification

The 2 stage audio frequency circuit is shown in Figure 3. The identification numerals indicate the same parts for numbers 1 to 15 inclusive as before.

16. 3-22 1/2 volt "B" batteries.
 17. 2 Audio Frequency transformers.
- Radio and audio frequency Amplification**
The ambition of every novice is to ul-

1. Antenna.
2. Ground.
3. Variocoupler.
4. 43 plate variable condenser.
5. 23 plate variable condenser.
6. Grid variometer.
7. Grid condenser.
8. Grid leak.
9. Detector vacuum tube.

"ALL-AMERICAN"
Radio Frequency Transformers
Efficient on 150-750 Meters,
Easy to tune, yet extremely
sharp—gives clear signals.
R-10. Price \$4.50
RAULAND MANUFACTURING CO.
35 South Dearborn Street, CHICAGO, ILL.

Headquarters for
Radio Supplies and Equipment
Radio Department
COMMONWEALTH EDISON ELECTRIC SHOPS
72 West Adams Street
Chicago, Ill.

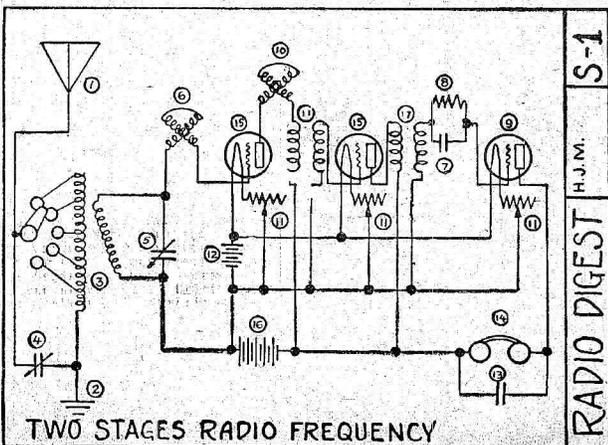

Figure 2

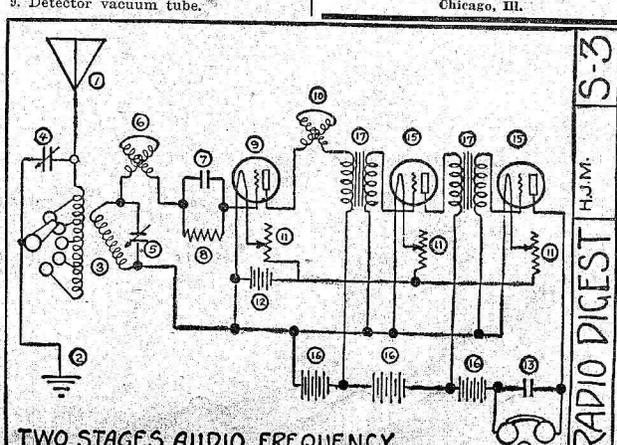
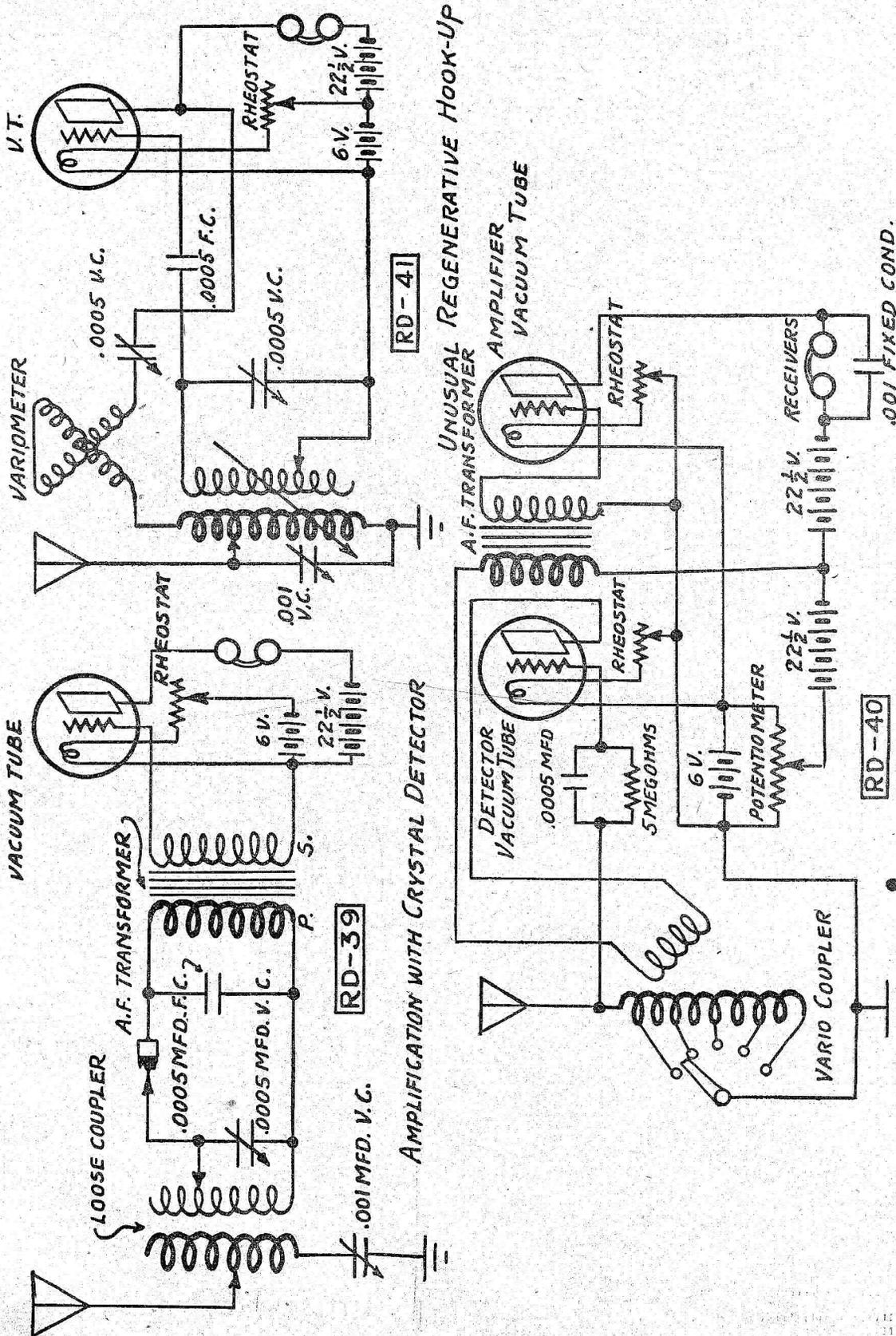

Figure 3

Radio Digest Illustrated

No 12

By: Harry J. Marx



Hook Ups

Questions and Answers

Variocoupler Set

(193) PW

I am an operator on a small scale and have some problems to present to you. You will find enclosed an addressed stamped envelope which you will use for the return of the answer.

1. I have an upright tuning coil of 80 turns of number 24 double cotton covered copper wire with 18 taps, taken off at the 10, 20, 30, 40, 50, 60, 70, 71, 72, 73, 74, 75, 76, 77, 78, 79, and 80th turns. May I place a secondary in the coil and use it for a variocoupler? If so what kind of wire and how many turns should be put on the secondary?

2. May an efficient VT set be constructed of a variocoupler, a variometer, variable condenser, and vacuum tube set consisting of tube, rheostat and socket?

3. Will this set be improved by adding another variometer?

4. What will be the range of the set?

5. If I may use the tuning coil with a secondary as a variocoupler, what kind of wire and how many turns of it must I use on the variometers?

6. If the variocoupler described is not suitable describe one which will be suitable, that is, give the size and kind of wire and number of turns on both primary and secondary.

7. Will an aluminum panel be suitable to use with this set?

A-1. Yes. No. 26 dcc. wire, 100 turns.

2. You will need "A" and "B" batteries, grid leak and grid condenser.

3. Yes.

4. Approximately 100 miles depending on aerial location and other conditions.

5. Any one from No. 22 to No. 30 wire, same size in both coils. About 60 turns on 3" diameter. Windings to be as closely balanced as possible.

6. Your variocoupler will do.

7. Yes, if insulated from switch contacts etc., and grounded. Why not use an insulating panel?

Radio Parts

(198) AC

I have been very much interested of late, in reading the columns of the question and answer page of the "RADIO DIGEST" and I would like to have the following questions answered.

1. When the a-c hook-up work and will it do about all the description of it states?

2. Would a fixed grid condenser instead of variable make much difference in the set's range and would it hamper sharp tuning?

3. Is a grid-leak necessary?

4. The hook-up shows no rheostat, but one is necessary of course, is it not?

5. Would an "Electron-Relay" detector tube with six volts for the filament and from 13 to 22½ volts for the plate be the best to use in the set?

A-1. Yes, provided your inductance and capacity are sufficient to take in the wave lengths you want to receive. See articles on page 12, Issues 9 and 10 of the RADIO DIGEST.

2. Fixed grid condenser limits tuning efficiency.

3. Not absolutely necessary, but it helps.

4. Yes if you want to get maximum results out of the tube, and to prevent burning out the filament.

5. All right. Any legitimate make will do.

Crystal Set with Amplifier.

(675) TA

I have followed your RADIO DIGEST along but I have not seen a hook up using a crystal detector and one step amplifier. Enclosed find such hook up which I am using with good results.

A-The hook up that you submit will be shown in RD No. 39, on page 15 of Issue No. 12.

Aerials

110) HGM

1. What type and length aerial should be used on a detector set and also a single tube set which will be 55 miles from Dallas, Texas, WRL, 300 meters length, 200 mile range? Please give per height, length, and kind of an aerial.

In the May 6 edition you show on page 13 a two honeycomb coil vacuum tube set. Please give me the kind and number of the condenser.

Aerial should be about 50-100 feet long, single wire, including lead-in and grounded lead-in.

Hard and Soft Tubes.

WFM would thank you greatly if you would answer the following questions in your issues and answers Department or by self addressed envelope enclosed.

Please distinguish between a "soft" and "hard" tube.

Will you please furnish me with a list for the type and the number of tubes to use for three coil sets composed of new Remler Coils, for all the different bands of wave lengths.

Will you please give me information on these coils you would give me a table of the

same thing only using duo lateral coils instead.

A-1-Soft tubes have a little gas content and are used for detector stage only. Hard tubes have a higher vacuum and are used for amplifiers.

2-The table for the proper coils to be used, was given in Issue No. 4, page 13.

Loop Aerial.

Am very much interested in your magazine and would like to know if you would answer a few questions?

I have a single-circuit single variometer 3 stage audio regenerative receiver at present 4 wire antenna 50 ft. long, 100 ft. high, lead in 20 ft. Am located near 3 bum stations that I wish to cut out, nearest one 4 blocks away. Would a first class 12 ft. loop mounted 90 ft. high on roof with Radio amp. help?

A-Not very well, except for directional control. Would suggest Radio frequency amplification, and only 2 stages of audio frequency.

Crystal Set.

(666) LB

Enclosed find 2 cent stamp for which you may send me the information I want to know.

I have a loose coupler and a mineral detector, 43 plate variable condenser and a pair of Murdock 3,000 ohm phones; now is there a hook up that I may use to hear Radio music, etc., or is that a sufficient outfit? I can receive wireless messages with it. If that is not enough will you kindly tell me what else I will have to have, and will you please send me some hook ups and I thank you very much; and also tell me which RADIO DIGEST it will be in.

P. S. Hate to ask it of you but if you have any extra Codes will you send me one.

A-Your set is not sufficient to receive Radiophone Broadcasting any distance. I would recommend at least a hook up similar to the one shown on page 13 of the 3rd Issue or RD 34 on page 14 of the 10th Issue RD 29 on page 14 of the 8th Issue will also give you good results.

We do not carry any Code copies.

Too Indefinite.

(667) FWB

Being a reader of your periodical will you kindly advise me in what the difficulty is that with a Westinghouse set with two stages of amplification. I am able to hear the several broadcasting stations on the detector but after receiving same am unable to step it up either to 1st or second stage.

A-Your hook up is wrong somewhere. I would suggest that you check up with the instructions given in Issue No. 4, page 5.

Short Aerial.

(668) CEI

Enclosed find stamped, addressed envelope. Will you kindly answer the following questions. I have a two slide home made tuner, with a crystal detector, fixed condenser and 3,000 ohm phones. I am located in Minneapolis where there are about 9 local broadcasting stations. I am only able to tune in to one of the stations, which is W.B.A.H. (The Dayton Company). My aerial is 25 feet high and 25 feet long. Do you think my aerial should be longer and higher? I cannot quite figure out why I cannot tune in with the other stations when I can the station mentioned O.K. The stations mentioned above use the 250 meter wave length. Please let me hear from you as soon as possible.

A-I imagine W.B.A.H. station is closest to you or has the greatest output. Your aerial is too short and rather low, so will not receive anything but the strongest reception. Increase the length, and height if possible, of your aerial.

Crystal Detectors.

(669) GV

I have been reading your questions and answers and they help me very much but will you please answer these questions.

1. I have a Radiocite detector, it is claimed to be the most sensitive crystal made. Is it better than Galena for Radiophone?

2. I have my own loose coupler from directions in your May 6 number. I wound the primary with 24 wire and secondary with 31. Will this work?

3. Can you show me how to make a good inexpensive variable condenser and with this condenser and aerial 120 ft. long and 50 ft. high single wire, the loose coupler, crystal detector, fixed condenser and 3,000 ohm Murdock receivers, can I hear concerts from Omaha, 67 miles away? If not, how could I increase the range to do so? About how far could I receive telegraph messages? You will oblige me very much if you will answer my numerous questions.

A-1. I don't think it is any better.

2. The winding of your secondary is pretty small gauge wire. It should not be smaller than No. 28.

3. On the "How to Make" pages we have given a number of instructions on variable condensers. Try some of them.

4. You expect too much for a crystal under summer conditions. Ought to have a vacuum tube. Your range for telegraph will be about 100 miles.

Transformers.

(670) WMCH

Will you kindly advise me what Radio and audio frequency transformers you recommend in connection with Figure 6 hook up on page 13 of May 20th Issue of RADIO DIGEST. Thanking you in advance beg to remain.

A-Any standard make of audio and Radio frequency transformers will give good results. The latter should not have too high an impedance.

Three Coil Set.

(671) GB

Please send me a hook up of a three-coil honeycomb coil set responding to all wave lengths and employing a vacuum tube.

A-See hook up RD 11, page 14 Issue No. 4.

Short Aerial.

(672) SW

My nearest sending station is Birmingham, Ala., about sixty miles. Please send "hook up" to receive this station on a loop.

A-See hook up RD 11, page 14, Issue No. 4.

2-You will require 120 ft. of wire in your aerial. Thirty feet vertical will not give you satisfactory results.

Reception Poor.

(673) EM

What is the difference in a long range receiving set and a short wave receiving set? We have a Westinghouse Short wave receiving set consisting of combination type RA Short wave regenerative tuner and type DA Detector and two stage audio frequency amplifier using detector tube CV 200 and amplifier tubes UV 201. We are not getting the results that we should.

Why is it that when we get something on, it fades away but if you will wait a minute it will come on again but will keep on doing that?

Why is it that when we get a lecturer or speaker on, that we can hear the voice plain enough but not enough to understand what they say? We get music better than anything but we are not able to bring it out as it should come. We are using one hundred feet antenna twenty five feet high above our building. Would two or more wires be better? Would a load coil be of any advantage? Would we hear Pittsburgh and Newark better. We have never been able to get Chicago, St. Louis, Atlanta, Montgomery, Memphis

or Pine Bluff, or any of the closer stations. We know it is the worst time of the year but it looks like if we get it at all we should be able to bring it out. We will appreciate your advice.

A-The difference between what you call a long range receiving set and a short wave receiving set, is that the one has a natural wave length of a 1,000 meters or more, while the other probably operates around 360 meters. Are your "B" batteries new, or have they been used for some time? Your tuning is not sharp enough. Two or more wires in your antenna will not help matters. Would suggest shunting a 43 plate condenser across your primary.

Relative Efficiency.

(674) TWC

I wish to ask you the following questions, which so far have not been answered to my satisfaction.

1-Which set is the most efficient, the variometer, variocoupler regenerative set or the honeycomb set?

2-Kindly publish hook up used in the De Forest Interpanel set as described on page 5 of May 27, DIGEST. Is this hook up more efficient than De Forest set standard hook ups as shown on page 13 May 27 Issue of DIGEST?

A 1-The variometer, variocoupler for short waves and the honeycomb coil for long waves.

2-We do not publish any of the hook ups used by manufacturers in our diagram page. The hook up is very similar to the one you mention.

Long Lead-in.

I have a two stage amplification vacuum tube detector set (Radiophone), but have not been very successful with it. Please answer the following questions:

1. For a location forty miles east of Lynchburg, Va., in what direction should the aerial run?

2. Does a long lead-in of insulated copper wire increase or decrease the efficiency of the receiving set.

3. Please advise me in regard to purchasing or making appliance lately invented by government experts, to prevent the crackling-in the phones caused by static in the air and where and how it is connected with the set.

A 1-North and South.

2-Increases the wave length with no change in efficiency.

3-Write to Dr. Louis Cohen, Consulting Engineer, Signal Corps, U. S. A. Washington, D. C.

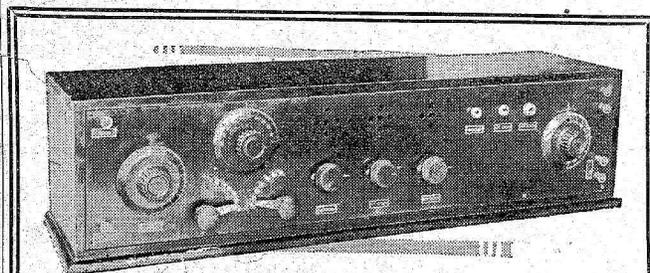

A High Class Long Range Receiving Set

With two stages of amplification
S. & H. MODEL No. 301
Immediate Delivery

RADIO-PHONE SALES CORPORATION

37 W. Van Buren Street Room 770 Old Colony Bldg.
CHICAGO, ILLINOIS

Dealers: Write for Special Proposition



The Radio receiving set was the only means by which this vaudeville dancer, Miss Pauline Chambers, could obtain music for giving an exhibition dance before a large crowd at the seashore.
© U. & U.



After a dip in the ocean the hair is wet and it takes time to dry it out. While these ladies are drying their hair they are entertained by Radio.
© K. & H.



Taking the "ouch" out of the bicuspid. This dentist says that pain is mostly in the mind. Take the patient's mind off the pain by Radio and the battle is won.
© Int.