

How to Operate New Christmas Sets

Radio Digest

EVERY
WEEK

PROGRAMS
Illustrated

TEN
CENTS

REG. U. S. PAT. OFF. & DOM. OF CANADA

Vol. XV

Copyright 1925
By Radio Digest Publishing Co.

DECEMBER 26, 1925

No. 12



“Happiness Boys” Bring Cheer Over Chain; The Station of Dream Daddy; Radio ABC’s; WQR Makes Itself Heard ‘Round World; Betty Crocker on Candies; What Is Radio Drama?

DILL MAKING PLANS FOR COPYRIGHT BILL

STATIONS THAT SELL TIME WOULD PAY ROYALTY

Proposes Charge for Music Proportional to Income Derived by Broadcasters Through Its Use

WASHINGTON.—A new copyright bill, designed to settle the present row between broadcasters and musical interests over royalties, will be introduced in the Senate by Senator C. C. Dill of Washington, early in this session. Senator Dill has spent a lot of time this summer looking into the question and has about decided the kind of bill he will introduce.

"My bill," says he, "will extend the present copyright law to take in the broadcasting of musical compositions. The subject is very complicated, and I believe the Senate will want to hear a lot on both sides of the argument before final action is taken."

"In the case of stations which sell time, I think a reasonable royalty should be paid to the holder of the copyright. I do not think that broadcasting stations should be compelled to deal with societies which are supposed to represent the copyright holders, but that they should deal directly with the holder of the copyright."

No Set Copyright Charge

"I think the royalty paid by a station for broadcasting copyrighted musical compositions should depend to a large extent on the charge made by the station in selling time. When the charge is big, the royalty should be proportionately increased. When the charge is small, the royalty should be smaller."

"I am not sure what we can do about stations that do not sell time. I think in the case of most stations that do not sell time, they derive profit from the station in publicity or good will. This, of course, cannot be reckoned in dollars and cents. It would seem that the royalty paid by these stations should be in proportion to the estimated size of their audiences, although I don't know how we will ever be able to figure that out."

"Music in the Home" Is Essay Contest Subject

WKAF, Milwaukee, to Give Baldwin Grand as Prize

MILWAUKEE.—WKAF, the Kesselman O'Driscoll-Hotel Antlers station, of this city, is conducting a most novel contest, the award to the winner of which will be a \$900 grand piano.

The contest has been under way for a few days and will continue until December 25. Every listener—man, woman, or child, whether he or she lives in Wisconsin, Illinois, New York, any other state, or Canada—has the privilege of participating. The piano to be given as a prize is a Baldwin, and donated through the courtesy of the Kesselman O'Driscoll music house.

In the WKAF contest all that is necessary is that the listener send in his name and address to WKAF, Hotel Antlers, Milwaukee, and in return he or she will receive the particulars of the contest. It involves the writing of a 35-word "essayette" on "Music in the Home." The particulars as sent out by WKAF explain the essentials to be covered in these 35 words.

Musical Comedy Stars Give Entertainment Over KYW

CHICAGO.—Members of the musical comedy, "The Daughter of Rosie O'Grady," appearing here, recently entertained the Radio audience of Station KYW with an hilarious half hour's entertainment. Among those who appeared on the program were Pat Rooney, III, and Marion Bent, stars of the play, as well as Frank Corbett, Miss Vivienne Glenn and Pat Rooney's Syncopating Symphonists.

Pat Rooney, recognized in the theatrical world as one of the greatest of dancers, gave a conglomeration of zippy cadence in clog, while Miss Glenn and Mr. Corbett entertained with vocal selections and the Syncopating Symphonists spilled volumes of the latest jazz numbers.

To Have Taxi Planes with Radio

STOCKHOLM, Sweden.—The Swedish Air Traffic society is planning to put into service a fleet of "taxi-airplanes," which the public will be able to hire per hour or per run, just as it hires a taxicab. One interesting feature about these air taxis is that it is proposed to fit them with Radio receiving sets, in order that the tedium of flying through the clouds may be relieved for the passenger by listening in to the various stations' musical programs.

BEAUTY ON COVER IS NOTED PIANO TAMER

AN ARTIST from the crown of her head to the tips of her fingers and every line a line of grace and beauty—that is the description of the decorative darling on the Radio Digest cover this week. She is Miss Lucille Fischer of the Lucille Fischer School of Music, Chicago, which shows that she has brains as well as beauty and is something of a business executive. When Balaban & Katz, the moving picture theater people of Chicago, want an exceptional pianist to please the customers at the Chicago theater and the Radio listeners over WMAQ, they send for Miss Fischer and the wildest piano eats out of her hands as happy as a kitten whether she feeds it jazz or the most difficult classics.

Harmonica Programs from WEAf Are Again on Air

NEW YORK.—As a result of the popular response to the series of harmonica programs and lessons broadcast through WEAf last winter by the "Hohner Harmony hour," they have been resumed from WEAf, being heard on Fridays at 9 p. m., eastern time, through WEAf, WJAR, WEEI, WOO, WCAP, WGR and WWJ.

So far as is known, this is the first attempt which was ever made to give instructions by Radio for the playing of a musical instrument.

Movie Stars Talk at Station KFWB

Warner Brothers Frolic Brings Many Luminaries of Screen Before Mike as Guest Announcers

HOLLYWOOD, Calif.—"Pretty soft for KFWB," is the verdict of station managers, who listen to the Warner Brothers' frolic from 10 to 11 p. m., pacific time, each night at that station.

During the past two months the following Warner Brothers movie stars have appeared at KFWB as guest announcers: Syd Chaplin, Alice Calhoun, John Haron, Irene Rich, Huntley Gordon, Dolores and Helene Costello, Theodore Lorch, the heavy in "The Man on the Box," Marie Prevost, Gayne Whitman, Louise Fazenda, Willard Louis, Lee Duncan and Rin-Tin-Tin, Vera Reynolds, Matt Moore, June Marlow, who plays opposite John Barrymore in Don Juan, Dorothy Devore, Patsy Ruth Miller and a number of lesser stars. Several famous directors have tried their hands at directing a Radio program, among them being Erle Kenton, Bill Beaudine, known to fans as B. B., and Chuck Reisner, who in addition to directing Syd Chaplin's comedies usually plays a part in them.

A broadcasting station that furnishes a regular program by high-grade artists and whose equipment furnishes an output of dependable quality and steadiness, costs in the neighborhood of from \$30,000 to \$100,000 a year to operate.

DELUGE OF COLLARS FLOODS ANNOUNCER

LISTENERS SEND McNAMEE MANY UNUSUAL GIFTS

Remark Made in Pittsburgh That He Couldn't Keep Collar Clean Brings Aid

NEW YORK.—Little collars, big collars, soft collars, starched collars—forty collars of every description—were among a large number of unusual personal gifts sent to Graham McNamee, popular Gold Medal announcer of WEAf, by Radio fans who heard his statement that he couldn't keep his collar clean at Pittsburgh while he was putting the play-by-play account of the World Series on the air.

Besides the collars, McNamee received a hand-forged horseshoe, about as big as a dime, a basket of grapes, a luscious chocolate cake, eggs, some of which before reaching him had "gone wrong," a dictograph cylinder (broken in transit), which evidently contained a record of his broadcasting, a sweater and a bead watch fob with his initials worked in.

Interesting Cross Section of Audience

Thousands of letters were received from fans in every part of the country expressing their appreciation and revealing many interesting angles on the variety of listeners and on the most unusual conditions of reception.

Hundreds of disabled war veterans, hospital patients, elderly men and women and others who were unable to attend the contests seemed to have received the greatest delight from the games. In several cases prisoners used half of their letter-writing privilege (of two a month) to express thanks for the broadcasts.

Lighthouse and lightship keepers, isolated farmers and farm wives, striking coal miners in Pennsylvania, old maids who didn't understand the game, former ball players, priests, ministers and school children enjoyed the series with equal enthusiasm—and sent collars.

SHORT WAVES

By Marcella

The team of Little and Small, which became so popular last season, teams no more. It is reported that matrimonial entanglements of Jack Little broke up the team. Jack Little is still touring the stations, and so is Paul Small, but both are alone.

The "Harmony Girls," Grace Ingram and Edith Carpenter, are now doing their duets over KYW's mike. Hard to beat them, isn't it. No, neither of them is married.

Lambdin Kay, "The A-a-t—lan—tah Journal," is rather a set bachelor, I fear. Too bad, isn't it, when one of us girls would be so proud of him!

Another man I like is "Bill" (W. G.) Hay, formerly of KFKX, Hastings, and WOK, Homewood. Heard him the other night at WGN. He sure picked a dandy cook in Mrs. "Bill" too. I know because I've eaten her lemon fluff pie. By the way, lady friends, Bill is only in Radio as an avocation. His business is—ah, guess—ladies' ready-to-wear and he's located right across from the Drake hotel on Michigan boulevard, Chicago.

Kay Ronayne, WEBH singer on the regular staff, is a wonder when it comes to coiffures. Every night she wears it different. Boy friends, you must go up to the Crystal studios of the Edgewater Beach hotel and put your noses against the plate glass window.

What deep secret would you like to know about your favorite broadcast star? Drop me a note, girls, and I'll do my best to answer it here.

—Marcella.

Canadian Radio Convention

MONTREAL, Canada.—Under the auspices of the Quebec division, the first all-Canada convention of the American Radio Relay league was held here recently. This convention brought to Montreal some of the most eminent Radio experts on the continent. Among them was J. I. Thompson, chief engineer of the Marconi company, who has just returned from England where he has been making tests of beam transmission, which is to be installed between England, Canada and Australia to unite the Empire by Radio.

WGES Broadcasts Church

CHICAGO.—Services from the Austin Methodist Episcopal church here, are now broadcast every Sunday morning from WGES, Oak Park. At 10:15 a. m., central time, the service opens with a pipe organ concert and singing by the choir.

CONTENTS

Radio Digest, Illustrated, Volume XV, Number 12, published Chicago, Illinois, December 26, 1925. Published weekly by Radio Digest Publishing Co., (Incorporated), 510 N. Dearborn Street, Chicago, Illinois. Subscription rates yearly, Five Dollars; Foreign Postage One Dollar additional; single copies Ten Cents. Entered as second class matter at the post office at Chicago, Illinois, under the Act of March 3, 1879.

All the Live News of Radio.....	1 to 11
Radio Drama to Make Great Strides in 1926.....	4
"Happiness Boys" Bring Cheer Over Chain.....	5
WOB, Newark, N. J., Heard Around the World.....	6
"Dream Daddy" at WLIT Has 22,000 Kiddies.....	7
Women's Page; Index to Women's Programs.....	11
Advance Programs for the Week.....	13 to 21
An Evening at Home with the Listener In, a chart in central time, showing when to listen in for stations.....	20
Editorials, Indi-Gest and Condensed by Dielectric.....	22
Installation and Care of the Christmas Set, Part I—Antenna and Ground Suggestions, by John G. Ryan.....	23
Straight-8; Outside Aerial Tuned R.F. Super, Part II—Drilling and Assembling, by Jacques Fournier.....	25
Applied A. B. C. Principles of Radio Reception, Part II—Duties of a Train Dispatcher, by Carl Patterson.....	27
Code Practice Buzzer Easily Made; Other Kinks.....	29
Directory of Radiophone Broadcasting Stations, Part I.....	31

Looking Ahead

Back in 1921 when Radio Broadcasting was in its swaddling clothes, along came the Harmony Girls, now of KYW, Chicago, singing lullabys and thrilling the world's first Radio listeners. And now that Radio has grown up to knee pants they are still with it, as sweet and wonderful as ever. Next week's Radio Digest tells the tale with pictures.

Saws, Pitchforks and Numerous Other Ancient and Honorable Implements of Toil step out of their usual vocations and become musical instruments for Radio listeners. Queer contraptions from foreign lands also contribute their eccentric harmonies to the grand ethereal chorus. See the pictures and read about them in the next Radio Digest.

The Coo Coo Club at WTAM Broadcasts the Very Elixir of Life and has a very interesting history. Consider the aged little canary at Madison, Wis., which had given up singing three years ago, then suddenly came to life and sang like a two-year-old when the family Radio brought in the Coo Coo club. Story in next issue.

A Galaxy of Southern Beauty Connives with Mike at KWKH, the Shreveport, La., station to give listeners over a wide area a thrill through the air. Read about KWKH in the next Radio Digest. Oh yes, and see pictures of the beauties.

The Owner of a New Christmas Set will find that Mr. Ryan continues his discussion of installing and care in next week's issue. There is much for the novice to learn to get best results.

Wiring the Straight-8 Super-Heterodyne will be the third article of the series by Mr. Christen and Jacques Fournier. This receiver is very close to the "last word" as it combines the great pickup of the outside aerial with the range and selectivity of the super.

Applied A. B. C. Principles of Radio, as illustrated by comparison to a railroad system, takes up the increase of sound volume next week.

Newsstands Don't Always Have One Left

WHEN YOU WANT

Radio Digest

YOU WANT IT!

BE SURE OF YOUR WEEKLY COPY BY SUBSCRIBING NOW

SEND IN THE BLANK TODAY

Publisher Radio Digest,
510 N. Dearborn St.,
Chicago, Illinois.

Please find enclosed check M. O. for Five Dollars (Six, Foreign) for One Year's Subscription to Radio Digest, Illustrated.

Name

Address

City..... State.....

LIBERTY BELL TO PEAL FREEDOM

CONTEST IS ON FOR RADIO PLAY SCRIPT

DRAMA LEAGUE JOINS WLS TO PUT SHOW ON AIR

Prize-Winning Play to be Staged Over Stations of Country by Special Company

CHICAGO.—For the purpose of improving Radio programs a national Radio play contest has been launched through the joint efforts of the Drama League of America and WLS, the Sears-Roebuck Agricultural Foundation station, Chicago.

The announcement of this nation-wide contest to find the best Radio play was recently made by George Junkin, field secretary of the Drama league, who as chairman of the contest committee worked out the details of the contest with D. D. Richards, assistant director of WLS.

To the victor of the contest will be given \$500 in cash and a silver loving cup, in addition to national fame as writer of the best Radio play and the distinction of having assisted in producing better programs for the millions of the country's ether audience.

Three Prizes in All

A second prize of \$200 will be awarded to the runner-up and for the third best \$100 will be given. Any man, woman, or child in the United States is eligible to submit manuscripts of their plays. The contest will be conducted under the auspices of the Drama league. The prizes have been donated by WLS. According to the rules, the contest will close February 1, 1926 and all manuscripts must be received on or before that date.

As soon as the best play has been selected by a committee of experts chosen by the Drama league, preparations will be immediately made to produce the prize-winning play through WLS and many other stations of the country by means of a special company under the direction of the league. The rehearsals will be so timed that the nation's best Radio play will be produced for the benefit of the air audience during National Drama Week, February 14 to 20.

Requires Special Technique

"Radio will not allow any sly stage business", said Mr. Junkin. "Glances, asides and business with props cannot be put over to the Radio audience. Entrances and exits must in some way be told in the action of the play. Just as the movies brought about the new drama and a new way of presenting it, so will Radio. Sounds will be the principal vehicle. Bells of all sorts, church, dinner, telephone, house and others can be used to advantage. Rain, storms, musical backgrounds, horses, airplanes, automobiles—all have sounds which can be duplicated and will lend life to the words and action of the Radio play.

"Just as the movies have developed from the old-time chase, the presentation of fire departments in action and people shown merely walking and riding, to the presentation of the very best in drama, so Radio must take on another and more permanent form of presentation if it is to be expanded and live in the popularity of the greatest audience in the world."

Rules of Contest

The rules which will guide the contestants in writing their plays are as follows:

Any play submitted must be original and not have been printed.

All manuscripts must be typewritten double spaced. The author's full name and address should be sent with the manuscript but not on it. Manuscripts will not be returned.

Original one-act plays, eighteen to twenty-five minutes in length, are desired.

Few characters—maximum, five principals. Accompany action with notes on appropriate sounds. Farce, comedy, drama, melodrama, tragedy or mystery plays are satisfactory. Plays must be clean and wholesome material, and must not have material which would be objectionable to any sect or nationality.

Write plays as though they were to be produced for the blind. Everything necessary in the action must be made plain (to the ears).

All rights to the winning plays will be the property of WLS.

All manuscripts must be sent to WLS, Hotel Sherman, Chicago.

First Irish Station Is 2RN

LONDON, Eng.—The first broadcasting station in the Irish Free State has been erected by the Marconi company on the outskirts of Dublin. The transmitter, which will probably operate on a wave length of 390 meters and will use the call sign 2RN, is a 1,500-watt set.

East-West Classic Will Be Broadcast by KPSN

Pasadena's New Station Will Put Account on Air

PASADENA, Calif.—The big East vs. West football classic, held annually in the Rose Bowl during Pasadena's Rose festival will take place as usual this year on New Year's Day with the powerful eastern eleven making the journey to the coast to take on the western representative team.

The big intersectional game, held at a time when perfect football weather prevails in southern California, always draws a capacity crowd. This year the game will be broadcast for the first time, Pasadena's new station, KPSN, doing the broadcast by remote control and telephone lines. KPSN operates on 315.6 meters with 1,000 watts, and should be heard some distance.

NORSE BELL RINGERS GIVE UNIQUE PROGRAM

Premiere Artists of Europe Play Before KYW Microphone

CHICAGO.—A unique bit of program of the highest standard was recently broadcast from Station KYW when the Scandinavian Bell Ringers, recognized as the world's premiere organization of this kind, featured the Edison program.

The group consists of G. J. Holstrom, A. J. Holstrom, Theodore Kwanstrom, Edward Sundelin, under the direction of Alfred Josephson. In the different selections from 189 to 200 bells were played on an instrument that required one and one-half years to construct. The bells were manipulated by leather cords rather than striking them with a wand.

The entertainers are touring America, sponsored by Europe's greatest critics.

RADIO BEAUTY IS HIGH JUMPER



Mercedes LeCorgne has been "tickling the ivories" at WSMB, New Orleans, since its opening and her popularity continues to grow. In addition to being a talented musician and extremely easy to look at, she is champion high jumper of the Southern A. A. U.

Sydney Australia Station Enters Educational Field

WASHINGTON, D. C.—Educational sessions by Radio for the benefit of school children are being broadcast from the Sydney, Australia, station, 2FC.

A typical session for primary pupils recently included the singing of Alfred Hill's Maori Song, and an explanation of Mr. Hill's work at the university. Two "talks" followed, one on nature study by a graduate in the science, the other recalling that this year is the 150th anniversary of the Battle of Lexington.

Radio Aids Indians of Mexico

MEXICO CITY, Mexico.—The Mexican government announces that Radio is now being used to further the education of the Indians throughout the country. Reception posts have been installed in the most populous Indian centers, and instruction, varied by Indian music and entertainment, is being broadcast in no less than 17 different native dialects.

Opening Phrase Is Used to Send Letter to Announcer

NEW YORK.—Uncle Sam put one over on a Boston Radio fan and incidentally caused him to lose a bet. This particular resident of the Hub was willing to wager that a letter with no other address than "Good evening ladies and gentlemen of the Radio audience" would never reach Graham McNamee, popular announcer of WEAF.

This is the phrase McNamee invariably uses in making his opening announcements. Accordingly a letter so addressed with absolutely no reference to city or state on the envelope was dispatched.

To Broadcast Astronomy

WASHINGTON, D. C.—The Smithsonian institution and Station WRC have arranged with Prof. Harlow Shapley, director of the Harvard college observatory, to broadcast in Washington a selection of the Harvard observatory talks, under the direction of Dr. Shapley.

RADIO TO GIVE SOUND OF OLD RELIC TO ALL

Priceless Emblem of America to Herald 150th Year of Independence

Ring to Go World Over

December 31 to Mark Great Radio Feat—Millions of People Will Hear

PHILADELPHIA.—A wire interconnection and relays of Radio broadcasting that will reach every corner of the North American continent will carry the voice of the Liberty Bell throughout the land at the stroke of midnight, December 31, the moment when the new year, the 150th of American independence, is ushered in.

The shot fired at Lexington, was in an idealistic way, heard around the world, but on this occasion the real voice of liberty will be actually carried overseas to all peoples, if arrangements now under way are completed. It is planned to connect by means of Radio relays with several of the powerful European stations to rebroadcast the sound of the most famous bell of history, the ringing of which resulted in a new freedom for a country and an inspiration for greater ideals of liberty for the world.

Liberty's Sound to Surge Through Air

But once before has the sound of the Liberty Bell been sent over the country—on the occasion of the installation of the transcontinental telephone wire. Even then the sound was confined within a wire. This time the voice will fill the air; envelop the continent, as completely as the spirit of independence once surged over the Colonies.

Philadelphia is planning a colorful ceremony to mark the event and the traditional New Year's reception of the mayor will be transferred from its accustomed place in the City hall to Independence hall and the confines of Independence square. Following the ceremony, the Radio program to broadcast the ringing of the bell will be conducted, commencing at 11:30 o'clock, eastern time.

At exactly midnight, Mrs. W. Freeland Kendrick, wife of the mayor, using a hammer muted with rubber padding, will begin to tap the bell. She will indicate the year 1926 with 1—9—2—6 taps properly spaced.

Bell Protected from Harm

All precautions against hazard will be taken. It has been determined that no danger to the Liberty Bell will result from its being rung again. Alexander E. Outerbridge, Jr., professor of metallurgy of Franklin institute, has assured that since the installation of the mechanical device technically known as a "spider," there is no longer any danger in tapping the bell in the manner contemplated.

Professor Outerbridge said, "Years ago I was requested to make an examination of both the old and new cracks in the bell and found there was actual danger of a large piece of the bell falling off, if it should be subjected to even moderate shocks or vibrations. Happily that risk was removed for all time by the clever device mainly devised by the late J. Sellar Bancroft, an eminent mechanical engineer of this city. It was due to this that the bell made the journey to San Francisco and return without any harm."

What stations will broadcast the ringing of the bell have not been announced, but it is probable that the WEAF chain and many other stations will handle the program.

Major Bowes to Have More Family Microphone Parties

NEW YORK.—Several weeks ago, Major Edward Bowes, "father" of the Capitol theater "family," broadcasting over WEAF, conceived the happy idea of introducing to the microphone various members of the "family" who operate behind the scenes of the world's largest theater, and have heretofore never been heard by the Radio audience. This innovation met with such great response that the Major has acceded to the many requests that have come in through the mail, and will have more "family" parties.

Radio Drama to Make Big Strides in 1926



TenEyck Clay as Horatius and Miss Rosaline Greene, his leading lady (above). Mr. Clay is director of WGY players.



"Mile High" Radio drama is broadcast from KOA, Denver, where Miss Iris Ruth Pavay (left) is director. "Come Out of the Kitchen," (top) scene from one of her productions with KOA players. Earle Emlay (below), one of the KGO players at Oakland, Calif., who appeared in "Merrily Merry Ann," under direction of Wilda Wilson Church.

FORWARD looking counsellors of the Radio world who keep a constant finger on the pulse of public appreciation predict there is to be pronounced development of the Radio drama during the year 1926. Players and producers are gradually evolving a technique by which illusions can be carried to the ear where vision is denied. There is growing up a new sect in the writing craft which employs more skillfully and deftly that latest handmaiden—psychology.

Mechanics and properties are being improved. Transmission operators are reaching out for new tricks in effects corresponding to the camera tricks of the motion picture photographer. Closeups and vignettes must find their correlative effects through regulation of the current in emphasis of sound. Articulation on the

part of the player must be refined to a hair's breadth of gradation. A sigh may be made more effective through the microphone than it ever can from a distant stage.

A mother's prayer may be whispered into the microphone so intimately and directly that the listener will have an experience never made possible from the visible stage. The hushed voices of the sweetheart and the lover can come from lips so close to the listener's ear that a charm can be produced totally unapproachable through any other medium.

All of these things are being worked out by very competent artists in all parts of the United States. Where the moving picture without sound tells character by "business" as when a surly man kicks an inoffensive dog and the tender-hearted hero binds the animal's injured paw with a handkerchief, the Radio churl snarls a vicious command, a thump and the simulated pained cries of the pup followed by the indignant protest of the hero coupled with soothing words to the dog, like "never mind old fellow, here's a nice soft handkerchief and I'll fix it up fine for you. Come, let's see the paw."

Wilda Wilson Church, who has done notable work at KGO, (the General Electric Pacific Coast station), finds that producing such masterpieces as Drinkwater's "Abraham Lincoln" or Shaw's "Your Never Can Tell," offers the most interesting experience in a lifetime devoted to dramatic production. Mrs. (Continued on page 10)

Miniature Radio musical comedies were made by the three thinkers below (left to right), George V. Hobart, Lieut. Gitz Rice and Joseph Knecht, "Goodrich Zippers." Scene (lower left) from WLIT Radio-play.



Roberta Hoyt, 10-year-old audio player at KGO, right, and Wilda Wilson Church (below) who is making Radio drama history at KGO, Oakland, Calif.



"Happiness Boys" Bring Cheer Over Chain



"You tell 'em, Mike," and so Mike does—he always does when these three get together, because they are the famous "Happiness Boys" of WEA and they go on the air every Friday night. Ernest Hare (left) and Billy Jones are the team. Mike is the one that's all mouth—he tells the world.

By Jack Forres.

SEVEN flights up in an office building, where the roar and bustle of Broadway is barely audible, there is a door with gold lettering on it, reading: "Billy Jones—Ernest Hare, The Happiness Boys."

Approaching the door, strains of "I would rather, very much rather, be alone in the South," greeted me. The song was a real southern blues song, which ended as I passed into the office.

Sitting at a desk were Ernie and Billy, dispensers of happiness and good cheer. The spirit of the song had not dampened their ardor, for the good-natured grin on both faces seemed to light up the room.

When informed that I wanted a story on their rise to stardom, each one referred me to the other. Finally, Ernie consented to talk about himself.

"Did you hear the song we were singing when you came in?" he asked.

"Yes," I admitted. "It was about the South, and sung with quite a lot of feeling."

"Well, I did mean it, for I was born in the South, down in Norfolk, Virginia. From the time I was knee high to a grasshopper, I was always singing. This resulted in my being called down at school.

"I received my education in a semi-military academy at Norfolk. Instead of shouting orders to my squad, I used to sing them. The commanding officers could not agree with me that this would make a hit with the boys, so our relationship became strained. The officers were very much relieved the day I graduated, for that stopped the singing of orders.

"A commercial traveler in those days was considered quite a person. Anyone could follow a military career, but to be a commercial traveler—well—that was the acme of perfection. My mind was made up, so I landed a job as one, and held on to it for five years.

"My customers kept telling me that I would make a better singer than I would a baking

"Bulging biceps make a strong larynx," says Happiness Billy; so here he is after a couple of rounds as a part of his workout with Light Heavyweight Champion Paul Berlenbach (left).

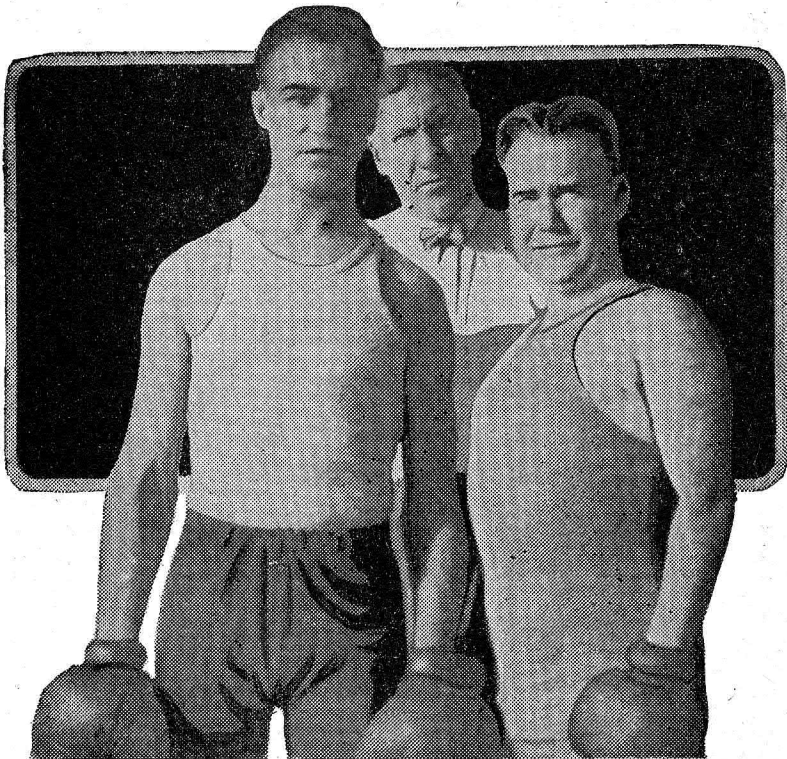

powder salesman. To find out if they were kidding me, I went to Baltimore and sang in a church choir for about a year. That settled it, I made up my mind to go on the stage. In 1905, some company picked on me, so I began to tour the country.

"New York greeted me in 1908. The show at the Winter Garden where I was playing, drew capacity houses. Whether it was due to me, or because of me, I don't know. The last show on Broadway that honored me by counting me in the cast was 'Sinbad.' I was understudy for Al Jolson, and was said to have played the part successfully.

"Recording for phonographs was in vogue at that time, so I signed a contract to sing for one of the recording companies. It was while singing for the records that I met Billy.

"Now, Billy," Ernie continued, "you tell him your side of it. I want to laugh."

And Billy Jones, the other half of the Happiness team, began to describe the high lights in his past career.

"Where was I born? Right here in little old New York. I am the rebel of the team. My musical career began when I was a kid, in one of the churches.

"I often heard that travel broadens one's mind, so I decided that I would visit the old folks in Wales. A good portion of my early life was spent herding sheep on a ranch in North Wales. I guess I have worked at practically every known trade or vocation in existence since that time.

"The first big show that I ever played in was Lew Fields' 'Midnight Sons.' After the finale on this show, I entered vaudeville. It was at this time I decided to try the heavy acting, so I became a member of a dramatic troupe playing 'The Necktie Party.' The war came along and broke up this wonderful meal ticket.

"After the war, I returned to vaudeville, doubling with Bert Grant in 'big-time.' When we arrived in New York after a successful trip on the road, I thought that I would like to try recording for the phonograph companies. For two years I sang under the name of Victor Roberts. It was there I met Ernie, as he told you before." (Continued on Page 10)

Six Continents Hear WOR at Newark, N. J.

Sometimes the boss himself relieves the announcer at WOR and below we see Mr. Louis Bamberger of the Bamberger Department store, Newark, N. J., taking a turn at the WOR microphone of the Bamberger store.

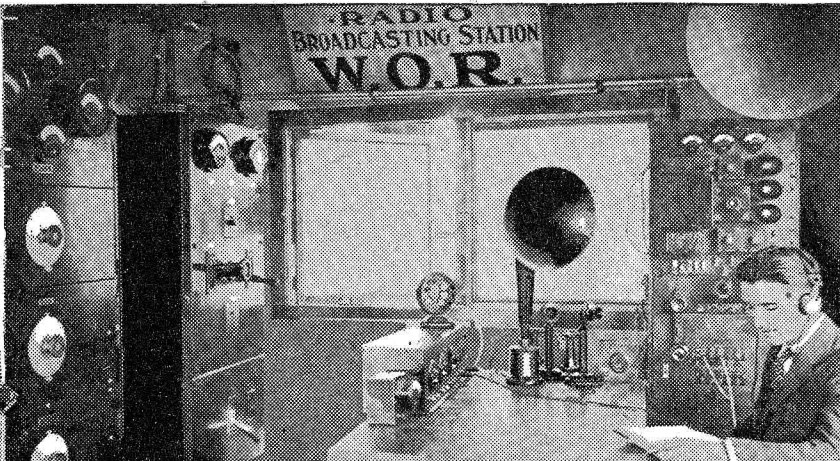
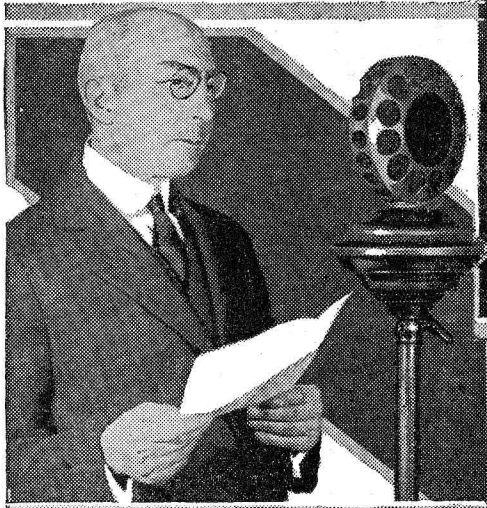

At the left is the transmission room of this famous Newark station and below is "Hollywood" McCosker who has brought many a cackle from dry throats by his "Broadway Bed Time Stories"—ever hear him?

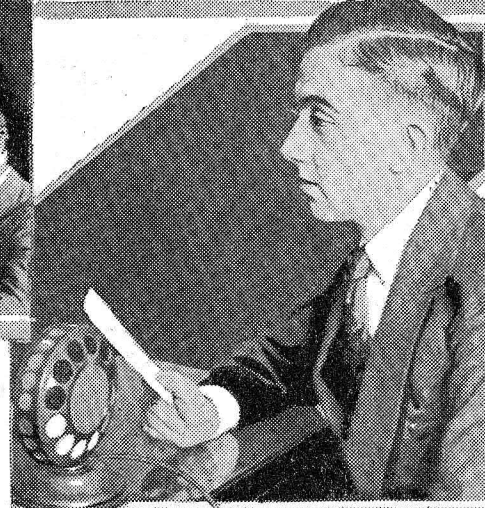

SOME day Mr. Louis Bamberger may call the boys together at Radio Station WOR, located on the Bamberger store at Newark, N. J., and decide to adopt a new slogan.

It probably will be something like this:

"WOR—Heard Round the WORLD."

And there may be some justice to the claim. Records show that WOR has indeed been heard on six continents and as we go to press that is about all the continents that are doing any broadcasting since Gene McDonald and Donald B. McMillan have brought the Peary and the Bowdoin back from Baffin's Bay leaving the other undiscovered continent for next season's hunting expedition.

So adding them all together—North America, South America, Europe, Asia, Africa and Australia sending in their

applause cards—why not come right out with it and admit that WOR has been heard around the world?

Early in 1922, WOR went on the air with the original DeForest transmitter which was used by the noted inventor for his early experiments. In July, the same year, they installed one of the modern Western Electric broadcasting units.

WOR is owned by L. Bamberger and company, and as the slogan of the station goes: "One of America's Great Stores." In fact, it was the second department store in the country to enter Radio. The original impulse behind the Bamberger organization in entering the broadcasting field, was to offer an opportunity to aspiring young artists in the various arts to get before the microphone. Louis Bamberger prides himself in being a patron of the arts.

The original personnel of the station at the time of its inception was composed of three people. At the present time, fourteen are engaged in the handling of the station.

Joseph M. Barnett, or JMB, as he is better known on the air, is station director. He has been with the station since the beginning. His baritone voice has entertained thousands throughout the world. Surrounding his desk are photographs of various celebrities who have broadcast from WOR. It is said that nothing less than a "General" can hang in his collection.

The actuating standard for WOR's existence is to present better and greater programs, cognizant of the fact that there are more seats in the gallery than in the orchestra. This is the policy of Station WOR. Not such a bad goal, is it?

One of the greatest programs ever put on the air was through WOR. It was known as the Consul-General party, and was held December 31, 1924. Representatives of thirty-six nations gathered in the WOR studio, and extended their felicitations

to their countrymen both here and abroad.

The outstanding feature of the station is the educational angle that WOR presents. In each case they insist that the most noted exponents of the various branches of arts and science give their talks from an entertaining angle. This series ranges from Dr. Frank Vizetelly, lecturing on English, down to dancing lessons. In between are talks on home economics, political science and medicine. For the medical talks, only the outstanding members of the profession who are vouched for by the American Medical association, are permitted to give their views.

An act of Congress was passed thanking WOR for their cooperation in saving the Shenandoah, when it broke loose from its moorings early in January, 1924. The story is now history, but Secretary of the Navy Denby and Commander Kline made public a vow of debt the government owed the WOR microphone and those who were "standing by" during the trying hours of the night.

The WOR studio was also the



"Gannon will attend to it," they all say at WOR when any detail needs attention. They mean C. Feland Gannon (above). Joseph M. Barnett (right) is the conscientious director who brought WOR up from its infancy.



"One! Two! Three! Four!" J'ever get up in time to go through the dozens as they are broadcast from WOR? Well, this is the way it looks in the studio while you are doing the up and over (above). At right is a cozy corner in the WOR studio. Jack Poppele (extreme right) chief engineer.



scene of a national meeting. When people all over the country were attempting to gather funds for the preservation of the Thomas Jefferson home at Monticello, Va., instructions were given to the captains of the various teams over the United States regarding the progress of the fund.

The WOR chimes are a well known trade mark of the (Continued on page 10)

"Dream Daddy" at WLIT Has 22,000 Kiddies



"Rufus" Thomas Barker (left) and "Rastus" Forrest C. Dennis, the "dark clouds with a silver lining" at WLIT. Vaughn DeLeath (right), singer.



Florentine Quartet (left), Victor recording artists on WLIT staff. John K. Witzemana, violin; Francis J. Lapitino, harpist; Clement Barone, flutist, and Alfred Lennartz, cellist.

tion that made the "Dream Daddy" possible. We have no pictures of "Dream Daddy" because it seems he wishes to let the children imagine him as they think he is in their own minds. He really built up the Lit Brothers' Radio station through his popularity with the kiddies. And you should see that Rollin's Junior Syncopator orchestra!

Jill Club" of WLIT, until it has reached the point where hundreds of thousands of children are members of the club. His popularity can well be realized when it is noted that the files of the club show the photographs of 22,000 children.

His technical knowledge of Radio transmitting was gained while serving overseas with the United States Navy. He (Continued on page 24)

WHETHER parents are people or not has not been decided by the International Court of Domestic Relations, but, be that as it may, there no longer is any doubt as to what the kiddies of Philadelphia are. They are the original rag-time, hot-time, all-the-time Radio fans of America.

That's probably because of Harry E. Ehrhart, whose voice chuckles down out of the air into thousands of homes as the "Dream Daddy" of the Philadelphia Radio station WLIT. He is one of the original air saints of the many who have come into being to the great delight of children all over the world as the result of Radio. It's easier to believe in Santa Claus and witches and fairies and elves and all that because of the "Dream Daddys" and "Uncles" and "Big Brothers" who never are seen but who are real because the children can hear them.

But this is not alone a story about the kiddies of Philadelphia. It is about the very happy Radio sta-

Station WLIT started its career at about the same time with all other stations in Philadelphia, and has been operating full tilt ever since. Mr. Ehrhart was at one time Uncle WIP, of Station WIP, but when Lit Brothers constructed their station, he threw off the cloak of Uncle Wip, and put on one labeled "Dream Daddy." This was not all, however, as he was also made chief operator. When a change was made in the personnel about a year ago, Mr. Ehrhart became station director, which is a job in itself. And, oh yes, he is also known as announcer "H-double-E."

He built up the "Jack and



Let the Quaker fathers turn over in their graves for here is the latest edition of the syncopating age—Rollin's Juvenile Syncopators, Dream Daddy Ehrhart's boys at WLIT. What next? Babies rising out of their cradles to shake jazz rattles, maybe! Above, Pennsylvania Male Quartet; left to right—W. H. Carrint, J. S. Hinkle, Jr., Ernest T. Freas and C. D. Long.

The World's Greatest Radio Receiving Set!

New and Improved
**FRESHMAN
MASTERPIECE**

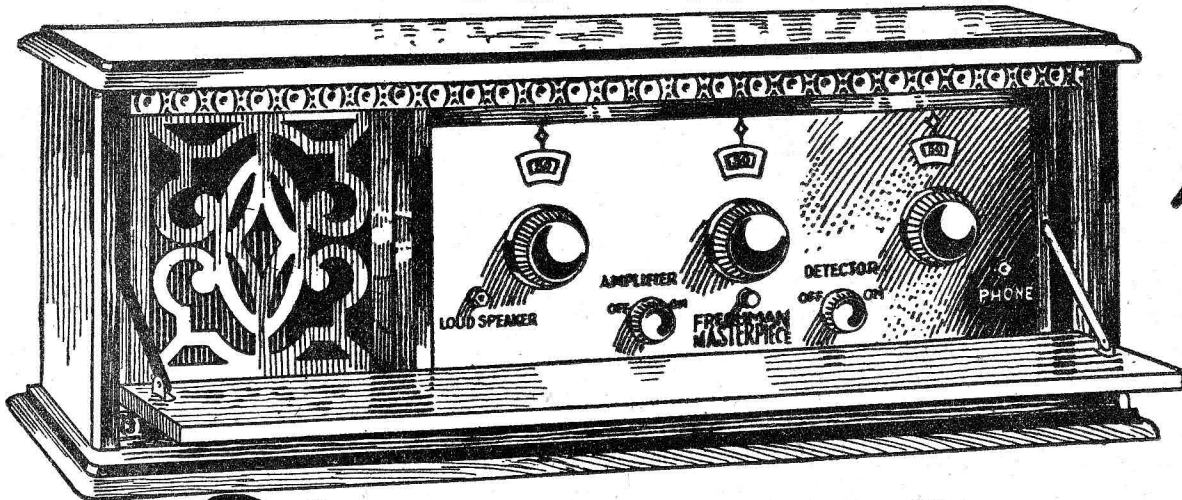

75

The Franklin Receiver
**With built in Loud Speaker of
Great Volume and Superb Tone**

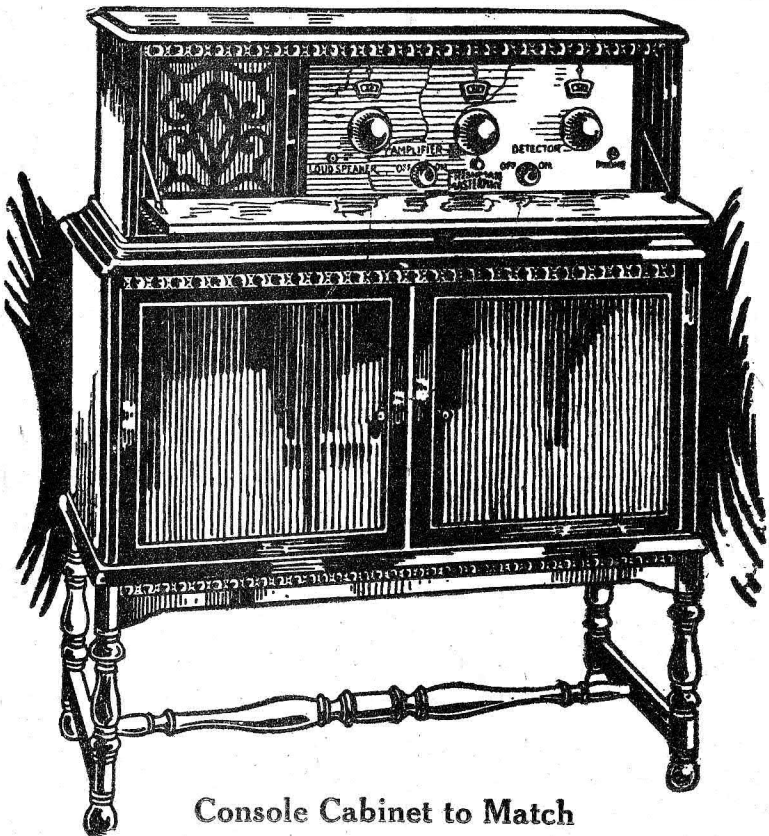

Console Cabinet to Match

Ruggedly built, heavy, five-ply genuine mahogany, the design of the cabinet is identical to the pattern of the receiving set. The doors to the compartments open from the front, affording ample room for all batteries, battery chargers, eliminators and every accessory that could possibly be used in connection with a radio set. This useful and attractive console cabinet is priced at only Forty Dollars.

The Freshman Masterpiece five tube radio receiver is known all over the world as the "WONDER SET." Its ease of operation, its distance getting ability and mellow tone have spread happiness and education in hundreds of thousands of homes in every part of the globe.

People who could easily afford to spend three and four times the cost of a Masterpiece for a radio receiver, have signified, in no uncertain terms, their decided preference for one of these "WONDER SETS." To satisfy this insistent demand we were induced to encase them in cabinets of rare beauty—fine enough for the most exquisite home.

The Franklin Model, illustrated above, is the pride of the Freshman line. This receiving set, with built-in loud speaker, is encased in a heavy five-ply genuine mahogany cabinet. The front cover opens in desk-like fashion, a most convenient and attractive arrangement. As a result you have the **WORLD'S GREATEST RADIO RECEIVER**, with built-in loud speaker, in a charming piece of furniture all for only Seventy-Five Dollars.

*Sold on Convenient Terms by
Authorized Freshman Dealers,
Who Also Install and Service Them*

Write for 24-page illustrated booklet full of useful information for all radio fans.

CHAS. FRESHMAN CO., Inc. Freshman Building, New York
2626 W. Washington Blvd., Chicago

LEADING ORGANISTS LEND TALENTS TO GREAT AND POPULAR SERIES

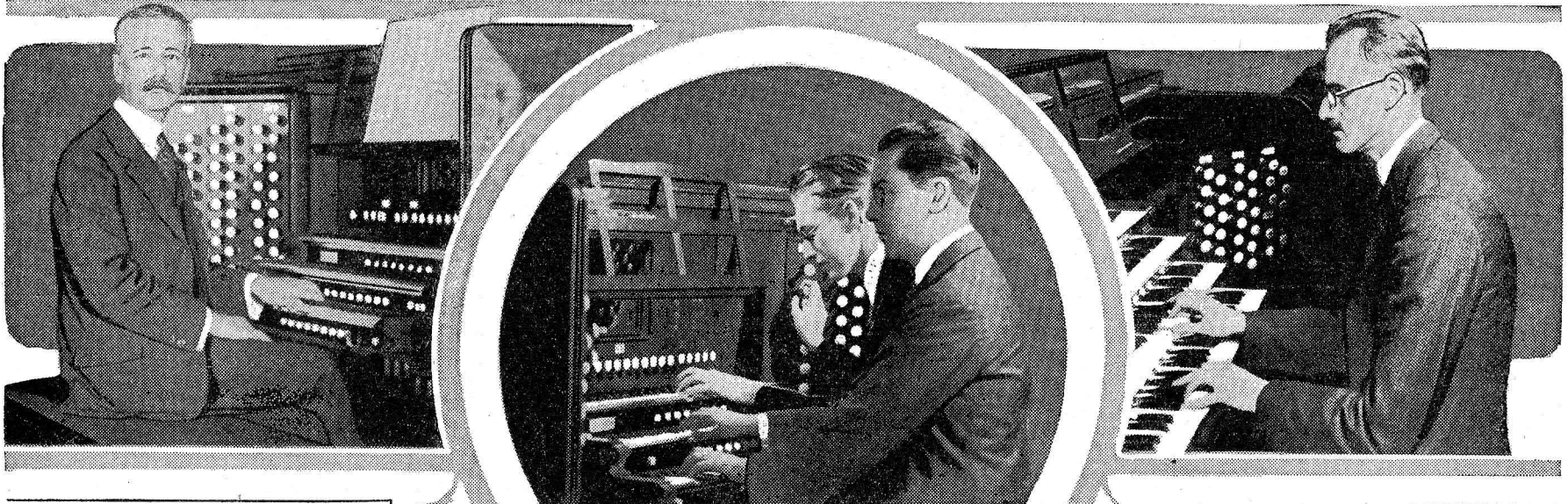

NEWS BRIEFS FROM THE BROADCASTERS

RADIO TO MAKE POSSIBLE TALKING MOVIE AT BALL

Boston Symphony Gives WBZ New Feature—CKY and WQJ Talk to One Another

Adele F. Woodard, who is heard on the morning programs of WEAJ forecasting the coming motion pictures, announces that the Radio listeners will be interested in the novelty movie ball December 29, because a feature of the entertainment program will be a "talking movie." This will reproduce both the motion picture of the orchestra in action and the dance music which the orchestra played while being photographed. This wonderful invention is a relative of Radio because the sound is amplified by Radio devices and through loud speakers. Dr. Lee DeForest, the "Father of Radio," invented the process.

Two announcers, through the assistance of Radio listeners, have been sending personal messages back and forth. D. R. P. Coats, director of CKY, Canada, started it by broadcasting a message to Jerry Sullivan, WQJ, Chicago. Fans picked up the message and relayed it to Jerry, who then broadcast a reply. This two-way conversation has caused the two stations and announcers to have a very friendly feeling for one another. CKY now plans to dedicate Monday programs to Chicago.

S. L. Rothafel, known as "Roxy," who first organized his now famous "Gang" about three years ago when Radio first came into prominence, is broadcasting a regular program from the studio of WEAJ, New York city, every Wednesday evening beginning at 10 p. m., eastern time. In addition to WEAJ, New York; WTAG, Worcester; WJAR, Providence; WEEI, Boston; WCAP, Washington, and WWJ, Detroit, will broadcast this weekly program with the probable addition of more stations during the coming weeks.

The Boston Symphony contributes to the new musical organization known as the Hotel Vendome ensemble which made its Radio debut Christmas night as an exclusive WBZ feature. This new organization is composed of internationally famous musicians, and will be heard from the Springfield station Friday evenings from 8:30 to 9:30 p. m., eastern time.

Sekatory Hawkins is well known to thousands of young folks throughout the country to whom his adventures have been related through the medium of the newspapers. Now Sekatory Hawkins is appearing via Radio. He appears on the programs of WLW, the Crosley Radio corporation station at Cincinnati.

A program of instrumental music will again be broadcast from WEAJ by the "Cushman's Serenaders" on Thursday, beginning at 7:30 p. m. eastern time. The Cushman Serenaders orchestra, which has become very popular with WEAJ's audience during the last few weeks, consists of three mandolins, one cello, two violins and two guitars under the leadership of Hugo Marini.

United States Marine band concerts from stations WJZ and WRC have been changed to Tuesday evenings at 7:30 p. m. eastern time. This band has been missed from the Radio programs recently and

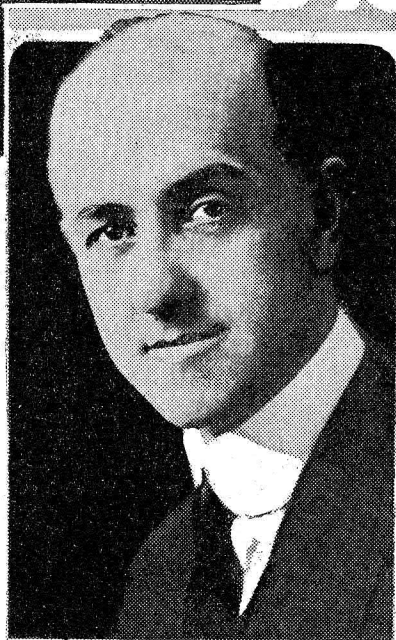
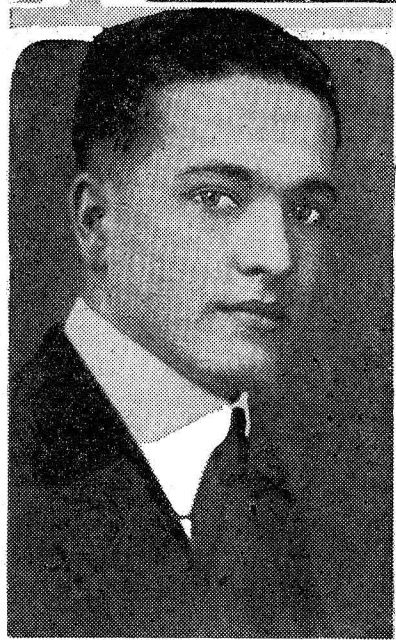

RADIO listeners in throughout the country have enthusiastically received and approved the "Great Artist" organ recitals broadcast each week by WAHG from the Skinner Organ company, New York studio, and the series is rapidly becoming one of the most popular features put on the air. Each Friday night from 8 to 9 p. m., eastern time, some nationally famous organist is heard on the program. The artists pictured above will conclude the present series, on which 36 of the leading organists of the United States and Canada have, or will have, entertained the Radio audience with their talents.

The dates of the remaining programs and the artists who will give the recitals are: December 28, Chandler Goldthwaite, who is shown at the left in the center

picture with Maurice Garabrant, who has played at more weddings than any other organist in New York and has also appeared on the series; January 1, Marshall Bidwell of Coe college, Cedar Rapids, Iowa; January 8, Dr. T. Tertius Noble, (upper left) of the St. Thomas church, New York; January 15, Dr. Gordon Balch Nevin, (upper right) of the First Lutheran church, Johnstown, Pennsylvania; January 22, Alfred Greenfield, (lower left) of the Fifth Church of Christ Scientist, New York; January 29, Rolfe Maitland, of Philadelphia; February 5, Lynnwood Farnum, (lower right) famous Canadian organist, February 12, William E. Zesch of Boston; February 19, John Priest of the Colony theater, New York; February 26, Harry Rogers Pratt of the University of Virginia.

FEWER STATIONS SEEMS SOLUTION

Congress May Be Asked to Reduce Number of Broadcasters to Aid Congestion

WASHINGTON.—Although the recommendations of the fourth national Radio conference provide for a limitation of stations, the only provision made to accomplish this end was to refuse licenses to new stations until the congestion has disappeared through stations dropping out.

It is the fear of officials here that the present congestion may not be materially removed by the conference action. There are at present entirely too many stations. Increased value is bound to be attached to a wave length after the recommendation limiting stations, and existing broadcasters are expected to hang on for dear life.

It is thought likely that congress may be asked to provide some method for decreasing the existing number of stations.

the reason is that the musical "Devil Dogs" have been "seeing the United States through a bass drum". By this it is meant that they have been touring the United States, playing concerts in all of the larger cities. Capt. Santelman is still the leader of this organization.

RADIO IS ADORED BY MARY GARDEN

Prima Donna Promises to Broadcast Her Voice as Often as Possible

CHICAGO.—Mary Garden is back in Chicago from Monte Carlo with a promise to entertain the Radio audience with her marvelous voice as often as possible this season. That Miss Garden has become an enthusiastic Radio fan is shown in an interview given on her arrival in the United States.

"I am Radio mad," she stated, "I adore it. I would no more think of traveling without a Radio than without my wardrobe.

"And do you know, I believe I have a good Radio voice? I am going before the microphone and sing as much as possible this season. I love it.

"You know, the Radio wasn't given us for dinky concerts. There are greater things in store for it. In fact, I believe we shall soon be able to tune in on Heaven, Mars and Venus, and those other places we think of."

Station Radio-Barcelona of Spain has signed a contract with the well-known Grand Theater du Lycee. For the sum of \$5,000 it has acquired the right to broadcast all operas, concerts or other performances given in the theater during the winter season 1925-26.

"RED-HEADED MUSIC MAKER" IN AMERICA

WENDELL HALL RETURNS FROM EUROPEAN TOUR

Telegraph Boys Have Work Again—"Rain" Song Proves Fad in Five Old Countries

NEW YORK.—The "Red-Headed Music Maker," Wendell Hall, has returned to the states from Europe, and once again his softly crooning ukulele songs have been heard by the Radio audience.

And he's more popular than ever before. Never in the history of Radio has an artist been missed so much and his absence so keenly felt by the Radio audience. Without the popularizer of "It Ain't A'Gonna Rain No More," Radio just didn't seem to be itself.

Wendell has been on a tour of Europe with his bride of a year, the girl the invisible audience heard him sing to so much, and later, the marriage of whom to their ukulele idol they heard broadcast to the world via the WEAJ chain.

The most-attended wedding in the annals of matrimony it was, and gifts poured in from the four corners of the country. Poured in? We should have said flooded in, for the listeners of the country liked Wendell and "his girl from Chicago," and they indicated their appreciation with gifts.

Entertaining Keeps Him Busy

Mr. and Mrs. Hall toured the country, went to Hawaii, toured the United States again—then the couple sailed for Europe. That was about three months ago. In Europe the newspaper correspondents say that Wendell's "weather prediction" song was earnestly learned by the Radio public of five different countries—in five distinct languages.

The overseas audience didn't want to let him leave, but their loss was America's gain. Anyway he belongs to us.

His first American appearance since his arrival was made over the WEAJ chain of stations on Tuesday, December 15, through the courtesy of the National Carbon company.

So Wendell is back and keeping the messenger boys busy again running to the studios at which he is appearing.

Want a Cute Lil Pup? Then Tune in Much DX

Reward for Record of Distance with One-Tube Receiver

CINCINNATI.—Six Radio enthusiasts will receive valuable pedigreed puppies from the best kennels in the country. These dogs are awarded for the best record of distance with a one tube Radio receiving set, either home or factory built. The contest started in September and will continue until March.

In addition to these dogs, Powel Crosley, Jr., who owns several hunting dogs, has donated \$1,000 as the reward to the Radio fan who proves he has received the greatest distance with a one tube receiver. Radio receiving sets have also been included in the list of prizes.

The judges have not completed their work in selecting the prize winner for September, as there were so many entries and each had to be thoroughly investigated. The puppy, a beautiful black with brown paws, is now in the Crosley kennels.

WOR "AROUND WORLD"

(Continued from page 6)

station. They are the original chimes used in broadcasting, and have been copied by a number of stations in one form or another for signing off and on.

It was the first station in the country to have a Radio wedding, and in the words of the celebrated "Hollywood" McCosker: "WOR played the part of everything but the bride." Houdini, who holds the long distance record for escaping and evading things, was arrested in the WOR studio. It was the only place in his experience from which he couldn't escape.

Among the celebrities who have faced the WOR mike are, Duke Boris, Lady Aberdeen, Dr. Adolph Lorenz, famous Viennese surgeon; Dr. Gustav Lindenthal, builder of the well-known Hell Gate bridge over the East river, New York; Charles H. Levermore, winner of the Bok \$50,000 peace prize, and numerous stage and screen stars.

One of the brilliant characters at WOR is Alfred J. "Hollywood" McCosker. He is in popular demand because of his "I See by the Papers" and his motion picture reviews. His past experience in the motion picture industry and newspaper field, makes him especially fitted to handle this phase of broadcasting.

Feland C. Gannon, assistant director, gives the fans a treat when he sings to them. His baritone voice is known to thousands of listeners throughout the world. Being one of the busy men at the station, his time is well taken up with numerous duties which prevent him from broadcasting daily.

J. Seabeck is the announcer. Listen to him some time and you are sure to come back for more. His clear enunciation and the tone of his voice are pleasing to the ear. It is seldom that Radio fans can listen to such a wonderful announcer. And when he sounds the chimes and you hear: "One of America's Great Stores," you know you are in for a treat.

RADIO DRAMA GAINING

(Continued from page 4)

Church graduated from the Boston School of Oratory years ago. She has taught English and dramatics at numerous leading colleges and schools throughout the country. She took an interest in the movies at one time, but found the work disappointing and is now convinced that the most interesting adventure in play producing lies in Radio.

"The conditions are different from any other work of this nature," she says. "There is, of course, no scenery, no setting of costume to create the necessary atmosphere, and everything has to be done by the voice alone, or by accessory sounds, such as the ringing of telephone bells or the slamming of a door. I try to use as few accessories as possible, getting the effects by speech alone.

"One advantage of Radio drama is that the parts can be read without being committed to memory. We usually need only three rehearsals. And, of course, there is no stage business to be learned, either.

"Our players find that previous experience on the stage is a great help, but not without its drawbacks. Those accustomed to depend to any extent upon facial expression, costume or action, are often at a loss when they find everything must be done by vocal inflection alone. For this reason, it is often possible to train beginners with no stage experience whatever so as to get excellent Radio results. But a trained dramatic intelligence is a great advantage.

"Another advantage is that parts can be doubled, the same player undertaking more than one role and differentiating between them by accent, pitch of voice, vocal inflection and so forth. This, of course, reduces the cost of production, but adds to the difficulty since the player must be careful to distinguish between the two parts so that each is identified with the same name and vocal characteristics throughout the play."

Much is yet to be accomplished by the coordination of music with words, according to Mrs. Church. As yet very little is really known about this phase of Radio drama. Recent experiments at KGO with educational drama, during which a boy and a girl and "The Old Man of the Rivers" drifted down the Volga river and talked about what they saw and heard, show clearly that music can be made an important part of the drama over the air.

Drama by sound alone is yet in its infancy and only a good beginning has been made, according to Mrs. Church, who sees it carried into educational fields with revolutionary results to methods now employed. Several educational dramas have been planned at KGO as a result of the "Volga River" playlet.

Many other stations have been making rapid strides in productions for the aerial stage. WGY at Schenectady, N. Y., is one of the pioneers in the eastern part of the country with its WGY players. Within the last few days they repeated their late musical comedy success, "The Hidden Idol." Their applause mail is said to have broken all records. The book was written by Witter Cook, a student at Massachusetts Institute of Technology. TenEyck Clay, who has been the director

for all the WGY productions, directed in this last success and took the part of the Rajah of Kookoostan.

In Philadelphia, Station WLIT produces Radio plays under the direction of Walter Greenough, assisted by Marlyn Brown and Isabelle Osserman. "The Green Goddess" was one of many successful Radio plays produced by the KOA players at Denver, Colo. In New York George V. Hobart, Lieut. Gitz Rice and Joseph Knecht collaborated recently for the production of the WEAf miniature musical comedies. In Chicago the Daily News station, WMAQ, successfully presented a number of Radio plays during the past year and the Evening Post WEBH Light Opera company presented many of the old-time light operas.

The Crosley superstation, WLW, has been making a thorough study of the Radario for its WLW players and has presented almost from the beginning some of the most successful Radio plays. This organization has been well in the foreground for the development of Radio play technique and out of its literary workshops are expected to come some of the most important developments for 1926.

WEAF HAPPINESS BOYS

(Continued from page 5)

After talking things over, both boys decided that there was enough room for another duet team, so they formed a partnership. This combination has been together for six years without even an argument.

The reason for this is due to the fact that Billy Jones goes out to Long Island and puts on the gloves with Paul Berlenbach, light-heavyweight boxing champion of the world. Two rounds with Paul takes all the fight out of him. Ernie is married—that speaks for itself. Even at that, he never has an argument with the wife.

The boys have made more records than any team in the business, and like Johnny Walker, they are "still going strong." Wherever they go, they are always known to radiate happiness.

Whenever they appear at a theater, the SRO (standing room only) sign is up at 7:30, proving how popular the boys are. While walking down the street in one of the large cities, a little boy came down the street with his mother.

"Oh, ma, look, th' circus is in town."
"Hush, child, that's only the Happiness Boys."

Their first broadcasting appearance was at WJZ when it was located in Newark. The studio was a corner of the factory draped off with curtains. Being one of the first to broadcast, they were asked to sing "plenty." They did!

After eighteen songs, the boys decided that they needed a rest, and informed the announcer, Tommy Cowan, of their desire. "Why don't you let the piano player give a few numbers," said Ernie. "But I don't know if it will reproduce," remarked Cowan.

"Well," came back Ernie, "there's no time like the present."

The piano player went on the air and "went big." The phone in the studio rang, and the voice at the other end of the wire complimented the station on the quality of the piano reproduction. This was in the days when a telegram from a town twenty miles away was quite a record. The boys entertained that night for about two hours.

A couple of years later they signed a contract to sing for the Happiness Candy company. Every Friday night from 8 to 8:30 they entertain thousands who are listening in on the WEAf link.

During a recent appearance at the opening of a store in Plainfield, N. J., their presence brought forth such a crowd of potential listeners that both front windows of the store were broken. To quell the eager mob, the police reserves of the town were called out. This proved the "smashing" popularity of the Happiness Boys.

They have appeared at all the large Radio shows in the East, and all they could possibly make in the West. It looks like a busy winter for the boys and, although they are not making a million, they do enough work to warrant it.

When I entered the door, the thought came to mind: "Why do they need an office?" After being with them for an hour, it was easily explained. The phone was ringing the greater part of the time, and visitors were going in and out. Song writers with new songs, the ice man, telegraph messengers and numerous others made up a steady stream.

People write in with original jokes asking the boys to give them the "air." They do, but not on Friday night. At the present time, the boys are favorites in the artists' popularity contest being conducted by a New York newspaper. The prize is a Packard car. Ernie owns a Chevrolet, Billy owns a Ford. They both expect to win the coveted prize.

Spain has granted 25 licenses for public broadcasting stations, of which no less than seven are in or near Madrid itself, but only eleven of the stations are actually working. Of these several are contemplating closing down, while all of them, with possibly two exceptions, are in financial difficulty.

Prest-O-Lite

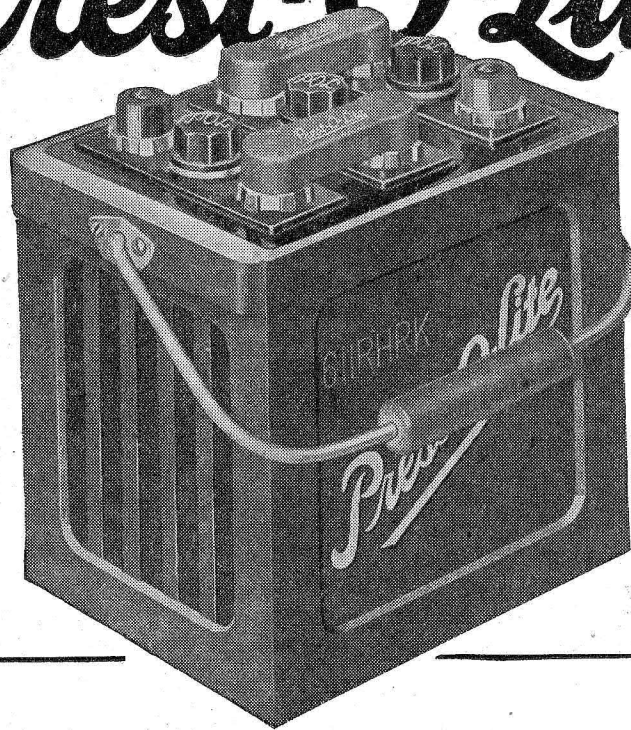

There are many improvements in the new Prest-O-Lite Battery

IN THIS new battery you'll find all the good points and high quality that have made Prest-O-Lite an un-failing aid to better radio. And in addition there are many important refinements and improvements that make it the most attractive, most convenient battery you can buy.

This new battery has a beautiful stippled finish hard rubber case that blends with any furnishings. The case is molded in one piece, giving sturdy, leak-proof strength.

To make the battery convenient to carry, the handle has been given a comfortable rubber grip.

The oversize terminal nuts on the binding posts are easy to turn and insure perfect contacts.

Novel rubber insulators completely cover the tops and sides of the cell connectors, preserving the original fine finished appearance at all times and giving protection against accidental short circuits.

No effort has been spared to make this a battery you will be proud to own. Yet, like the rest of the Prest-O-Lite line, it is priced to offer you the biggest value of the day. Ask your dealer to show you this battery and the Prest-O-Lite Chart that helps you select the right battery for your set. Or write Indianapolis for a copy of our interesting handbook on radio storage batteries and how to charge them.

THE PREST-O-LITE CO., Inc., INDIANAPOLIS, IND.
New York San Francisco

In Canada: Prest-O-Lite Company of Canada, Ltd., Toronto, Ont.

CANDY MAKING TOLD BY BETTY CROCKER

SUGAR AND WATER MAY BE MADE INTO DELICACIES

Popular Radio Cookery Expert Tells of Possibilities and Gives Recipes for Dishes

By BETTY CROCKER

Have you heard, and do you regularly listen for Betty Crocker's Radio talks? Miss Crocker is nationally known as a home food specialist who is broadcasting from a dozen of the country's largest stations. By special arrangement Radio Digest has secured a series of exclusive articles by Miss Crocker dealing with her current Radio talks. These broadcasts are made through WEEI, WEAJ, WCAE, WGR, WEAR, WWJ, WDAF, WHT, WFI, KSD, KFI and WCCO, the Gold Medal station at Minneapolis-St. Paul. All of Miss Crocker's recipes and discussions are based upon investigations and work of herself and her assistants in model kitchens. —Editor's Note.

EVERYBODY likes candy, and most of us like to make it. To the student of cookery there is no process more fascinating than sugar cookery. The results are nothing less than marvelous. We start out with plain sugar and water, put it over the fire in a sauce pan, and what is the result?—a soft, creamy fondant, a clear, fine spun sugar, a chewy butterscotch or caramel, sparkling crystal cups, or a brown, hard brittle.

The sugar chef goes even farther. He makes fascinating birds and flowers, and even statues and buildings—all out of the sugar and water. Although you may not be interested in the whys and wherefores of sugar cookery, it is interesting to realize the possibilities; and isn't it fun to make candy at holiday time?

Thermometer Is Necessary

Candy making is an exact science. The chef studies it for years before he can execute his wonderful creations. Candy must be cooked to exactly the right stage or else it is all wrong.

There is a definite stage at which it is exactly right, and it is very difficult to recognize that stage without a thermometer. Soft ball, hard ball, and thread tests enable you to get fair results, but the amount of sugar and fuel and time wasted on candy that was too hard or too soft would soon pay for a thermometer.

Chocolate Fudge

Fudge is one candy that seems to be a general favorite. Almost every girl can make fudge, and yet few of them can make soft, creamy, velvety fudge that literally melts in your mouth. Chocolate fudge made with this recipe is as different from the hard, grainy, sugary product as if it were another kind of candy. Here is the recipe:

Two cups sugar; 1½ squares chocolate (each square one ounce); 2/3 cup cream, milk or water; 2 tablespoons butter; ¼ teaspoonful salt; 1 teaspoonful vanilla.

Method: Add the sugar to the liquid. Add butter, grated chocolate and salt. Put over the fire and stir until sugar is dissolved. Cover until the boiling point is reached. Uncover and boil without stirring to 235 degrees Fahrenheit. (This is a very soft ball.) Add vanilla and cool to room temperature. Do not stir or agitate in any way until cool. Beat vigorously until the mixture sets when dropped from a teaspoon. Drop by spoonfuls on to a greased pan or waxed paper. If you prefer to have shaped pieces rather than dropped candy, knead the fudge in your hands until it is soft and creamy. Then mold in any shape desired or shape in a long roll and cut slices from the roll.

Peanut Brittle

If time is a factor, one of the most quickly prepared candies and yet one of the best is peanut brittle. No doubt you have made it many, many times before, but I have learned a few little tricks that may help you. This is the way we prepare peanut brittle in our model kitchen: 2 cups sugar; 1 cup shelled peanuts; ¼ teaspoonful salt.

Method: Place sugar in a smooth granite sauce pan or frying pan. Place over a slow fire and stir until melted. Scrape sugar from the sides of the pan and off the spoon. Have a warm buttered pan ready. As soon as the sugar is melted, add finely chopped peanuts which have been sprinkled with salt. Pour at once on to the warm pan. Square up the sides with two knives. Mark the candy into squares. If you want a peanut brittle that is not quite so hard to eat, you may add a tiny bit of soda with the peanuts. This will make the candy more foamy and not quite so brittle.

De Long Talks on Fashions

NEWARK, N. J.—Lucien DeLong, premier designer and stylist of France who is currently visiting in the United States, recently talked to the feminine members of the WOR Radio audience on "Present Day Fashions."

No important style conference is ever contemplated in Paris, the incubator of world fashions, without the presence of Lucien DeLong. His especially prepared style talk followed a tour of leading cities.

WAS MARK TWAIN'S SECRETARY



Miss Mary Louise Howden, who enjoyed the distinction of being secretary to Mark Twain at the time of his death in 1909, is shown above broadcasting some of her reminiscences over the WOR microphone on the last anniversary of the birthday of the famous humorist. The broadcast was made by direct wire from St. Mary's hospital, Orange, N. J., where Miss Howden, who has been confined to a wheel chair for the past seven years, gave the Radio audience interesting views into the life of Mark Twain.

Index to Women's Programs

Saturday, December 26

Eastern	Central	Mountain	Pacific
9:30 a. m.	8:30 a. m.	7:30 a. m.	6:30 a. m.
WWJ (352.7)	Tonight's dinner.		
11	9	8	7
WEAR (389.4)	Home service talk.		
12 n.	11	10	9
WQJ (447.5)	Looking Glass Reflections at Home.		
1 p. m.	12 n.	11	10
KMA (252)	Domestic science topics.		
12:35	11:35	10:35	9:35
KYW (536)	Table talk.		
4	3	2	1
KJR (384.4)	Tonight's dinner.		
7:15	6:15	5:15	4:15
KOIL (278)	Your House and Its Decoration.		

Monday, December 28

Eastern	Central	Mountain	Pacific
9:30 a. m.	8:30 a. m.	7:30 a. m.	6:30 a. m.
WWJ (352.7)	Tonight's dinner.		
10	9	8	7
WJZ (454.3)	Women's hour.		
10:45	9:45	8:45	7:45
WCAE (461.3)	Gold Medal talk.		
WEAF (491.5)	Home service talk, Betty Crocker.		
11	10	9	8
WEAR (389.4)	Home service talk.		
12 n.	11	10	9
WNYC (526)	Women's program.		
11:30	10:30	9:30	8:30
KFAB (340.7)	Home economics talk.		
12	11	10	9
WQJ (447.5)	Care of the Hair During the Winter Months.		
12:15	11:15	10:15	9:15
KYW (536)	A Heavenly Meal from Devil's Steak.		
12:35 p. m.	11:35	10:35	9:35
KYW (536)	Table talk.		
2:30	1:30 p. m.	12:30 p. m.	11:30
WGY (379.5)	Cooking lesson; Household talks. How to Select Furs.		
3	2	1	12 n.
WCOB (246)	Cooking chats.		
4	3	2	1 p. m.
WIP (508.2)	Market hints for housewives.		
WOC (483.6)	Home Management schedule, Aunt Jane.		
WQJ (447.5)	Hot Menus; New Year's Supper Suggestions.		
5	4	3	2
KJR (384.4)	Home helps.		
5:30	4:30	3:30	2:30
KFOA (454.3)	Today's recipe.		
6	5	4	3
KLX (508.2)	Women's hour.		
7	6	5	4
KTAB (240)	Women's club notes.		

Tuesday, December 29

Eastern	Central	Mountain	Pacific
9:30 a. m.	8:30 a. m.	7:30 a. m.	6:30 a. m.
WWJ (352.7)	Tonight's dinner.		
10	9	8	7
KDKA (309.1)	Domestic Science and Arts for the Housewife.		
10:45	9:45	8:45	7:45
WJZ (454.3)	Women's hour.		
11	10	9	8
WEAR (389.4)	Home service talk.		
12 n.	11	10	9
WMCB (340.7)	Homemaking hour.		
11:35	10:35	9:35	8:35
WITC (475.9)	Housewives' forum.		
12 n.	11	10	9
WQJ (447.5)	Early Spring Modes.		
12:35 p. m.	11:35	10:35	9:35
KYW (536)	Table talk.		
1	12 noon	11	10
KPO (428.3)	Domestic science talk.		
2	1 p. m.	12 n.	11
WGY (379.5)	Home Hygiene and Care of the Sick.		
3	2	1	12 n.
WLT (395)	Household helps and hints.		
4 p. m.	3 p. m.	2 p. m.	1 p. m.
WOC (483.6)	Home Management schedule.		
WQJ (447.5)	Seasonal Vegetables for Your Menus. Hooked Rugs. Putting Your Budget in Operation.		
5	4	3	2
KJR (384.4)	Home helps.		
5:30	4:30	3:30	2:30
KOA (322.4)	Housewives matinee.		
6	5	4	3
KOA (322.4)	Culinary hints.		
6:15	5:15	4:15	3:15
KOA (322.4)	Fashion review.		
7	6	5	4
KFOA (454.3)	Today's recipe.		
8:30	7:30	6:30	5:30
KGO (361)	As a Woman Thinketh.		

Wednesday, December 30

Eastern	Central	Mountain	Pacific
9:30 a. m.	8:30 a. m.	7:30 a. m.	6:30 a. m.
WWJ (352.7)	Tonight's dinner.		
10	9	8	7
WIP (508.2)	Menu.		
10:45	9:45	8:45	7:45
WJZ (454.3)	Women's hour.		
11	10	9	8
WRC (468.5)	Women's hour.		
12 n.	11	10	9
WCAE (461.3)	Gold Medal talk.		
WEAF (491.5)	Home service talk, Betty Crocker.		
1	12 noon	11	10
WFI (395)	Gold Medal Service talk, Betty Crocker.		
2	1 p. m.	12 n.	11
WTAG (268)	Talk to Housewives.		
3	2	1	12 n.
WHT (399.8)	Women's club.		
4	3	2	1
WNYC (526)	Women's program.		
5	4	3	2
KFAB (340.7)	Home Economics.		
6	5	4	3
WQJ (447.5)	Friday Fish dinner menu.		
7	6	5	4
12:35 p. m.	11:35	10:35	9:35
KYW (536)	Table talk.		
8	7	6	5
KPO (428.3)	Sewing talk.		
9	8	7	6
WOC (483.6)	Home Management schedule, Aunt Jane.		
10	9	8	7
WQJ (447.5)	Using Up Leftovers. Optimism and Osteopathy.		
11	10	9	8
3:30	2:30	1:30	12 n.
4:30	3:30	2:30	1:30
WLW (422.8)	Cooking school, hints.		
5	4	3	2
KFOA (454.3)	Today's recipes.		
6	5	4	3
KLX (508.2)	Women's hour.		
7	6	5	4
KMA (252)	Domestic science talk.		

Thursday, December 31

Eastern	Central	Mountain	Pacific
9:30 a. m.	8:30 a. m.	7:30 a. m.	6:30 a. m.
WWJ (352.7)	Tonight's dinner.		
10	9	8	7
WJZ (454.3)	Women's hour.		
10:45	9:45	8:45	7:45
WRC (468.5)	Women's hour.		
11	10	9	8
WEAR (389.4)	Home service talk.		
12 n.	11	10	9
WHT (399.8)	Women's club.		
1	12 noon	11	10
WQJ (447.5)	Using the Holiday Feast Leftovers. Marketing.		
2	1 p. m.	12 n.	11
12:35 p. m.	11:35	10:35	9:35
KYW (536)	Table talks.		
3	2	1	12 noon
KPO (428.3)	Domestic science.		
4	3	2	1
WGY (379.5)	The Family's Resources.		
5	4	3	2
WOC (483.6)	Home Management schedule, Aunt Jane.		
6	5	4	3
WQJ (447.5)	Home Economics.		
7	6	5	4
KFOA (454.3)	Home helps.		
8	7	6	5
KSD (545.1)	Women's Hour.		
9	8	7	6
KOA (322.4)	Housewives' matinee.		
10	9	8	7
KOA (322.4)	Culinary hints.		
11	10	9	8
6:15	5:15	4:15	3:15
KOA (322.4)	Fashion review.		
12	11	10	9
KFOA (454.3)	Today's recipe.		

Friday, January 1

Eastern	Central	Mountain	Pacific
9:30 a. m.	8:30 a. m.	7:30 a. m.	6:30 a. m.
WWJ (352.7)	Tonight's dinner.		
10	9	8	7
KDKA (309.1)	Domestic Science and Arts for the Housewife.		
10:45	9:45	8:45	7:45
WJZ (454.3)	Women's hour.		
11	10	9	8
WRC (468.5)	Women's hour.		
12 n.	11	10	9
WCAE (461.3)	Gold Medal talk.		
1	12 noon	11	10
WTAG (268)	Food hints.		
2	1 p. m.	12 n.	11
WHT (399.8)	Women's club.		
3	2	1	12 n.
KFAB (340.7)	Home Economics.		
4	3	2	1
11:45	10:45	9:45	8:45
WEAR (389.4)	Home service talk.		
12:35 p. m.	11:35	10:35	9:35
KYW (536)	Table talk.		
1	12 noon	11	10
WCCO (416.4)	Women's hour.		
2	1 p. m.	12 n.	11
KJR (384.4)	Home helps.		
3	2	1	12 n.
5:30	4:30	3:30	2:30
KOA (322.4)	Housewives matinee.		
6	5	4	3
WFAA (475.9)	Women's hour.		
7	6	5	4
KOA (322.4)	Culinary hints.		
8:15	7:15	6:15	5:15
KOA (322.4)	Fashion review.		
9	8	7	6
KFOA (454.3)	Today's recipe.		
10	9	8	7
KLX (508.2)	Women's hour.		

WOMAN'S CLUB HAS RADIO MEMBERSHIP

CONSIDER ALL LISTENERS NON-RESIDENT MEMBERS

Schenectady Organization Is First of Its Kind to Broadcast Complete Program

SCHENECTADY, N. Y.—All women within hearing distance of WGY may consider themselves non-resident, non-dues-paying members of the Schenectady Woman's club, as this organization, the first of its kind to broadcast a comprehensive program, is offering weekly special talks, and musical entertainments each Tuesday during the winter months. Every department of the Schenectady Woman's club is giving at least one afternoon program, especially for the non-resident Radio membership and the whole is under the direction of the Radio committee of the club, of which Mrs. W. D. Bearce is chairman.

Large Variety of Subjects

The program is especially noteworthy for the variety of the subjects discussed and includes talks on club work, individual political responsibility, conservation, home hygiene, psychology in child discipline, home economics, philanthropy, parliamentary law and the national characteristics of the drama of today. The entertainments include a program of Scandinavian music, drama reading, two-piano recital, piano recital, violin recital and programs by the club chorus.

Offer Hygiene Course

A feature of the programs is a series of six lessons in home hygiene and the care of the sick by Miss Anna McGee, R. N., chairman of the public health committee of the club and a member of the Schenectady county chapter of the American Red Cross. These lessons are built up from "Red Cross classes in the home care of the sick" and are given with the consent of the American Red Cross for the first time by Radio. The information given by Miss McGee should enable the woman in the home to cope with sickness when no nurse is available. Questions written to Miss McGee on the subject of home hygiene will be answered by her.

WEAF HOSTESS IS ALSO ANNOUNCER

Miss Betty Lutz Becomes Popular After Being on Air But a Few Times

NEW YORK.—Already letters are being received by the correspondence department of WEAF making inquiry as to the identity of the new announcer for the morning programs broadcast from WEAF, notwithstanding the fact that she has been on the air for but a few times. This new announcer is none other than Miss "Betty" Lutz, the charming hostess of WEAF, whose grace and courtesy have characterized her presiding over the affairs of WEAF's reception room and have endeared her alike to the studio staff, the broadcasting artists and the many studio visitors. To say that she has gained thousands of friends during her two years' service as hostess would be but faint praise indeed. Her morning announcements through WEAF are predicated upon the thousands of comments concerning her admirable personality which indicates that such a quality has become too valuable to confine to the studio with its limited opportunity to become acquainted with WEAF's Radio audience.

Because her new duties as announcer will be confined to the morning hours, she will continue to act in her capacity as hostess, thus not transferring her from the position in which she has achieved such popular success.

Design of Radio Sets Influenced by Women

Cabinet Receivers in Demand to Harmonize with Home

CINCINNATI.—Women's influence on the design of Radio sets is more noticeable this season than ever before, say Radio authorities.

The tendency in the newer sets is to build cabinets large enough to contain the batteries and to create cabinet designs which harmonize with the home surroundings.

Radio builders say that the movement toward self-contained sets can be directly traced to the influence of women buyers.

Many men like to tinker with their sets and make minor changes in an experimental way, but their wives usually object to the disorder.

Photogravures of Your Favorite Artists

GALLERY OF RADIO STARS

Suitable for Framing or Placing in Your Album

BY SPECIAL arrangement, Radio Digest is able to offer our readers a great opportunity to secure fine photogravures of their favorite Radio stars at practically no cost. Radio fans will be able now, by this very special offer, to have pictures of their favorite artists and announcers before them when they listen in.

All that is necessary to secure photogravures from the Gallery of Radio Stars is to send the coupon published each week in Radio Digest, accompanied by ten cents to cover the cost of mailing and postage. Where a series of three photogravures are desired, it will only be necessary to send twenty-five cents and three consecutive numbered coupons clipped from Radio Digest.

with coupons

Only 10c Each

3 for 25c

To cover cost of mailing and postage

with coupons

Only 10c Each

3 for 25c

To cover cost of mailing and postage

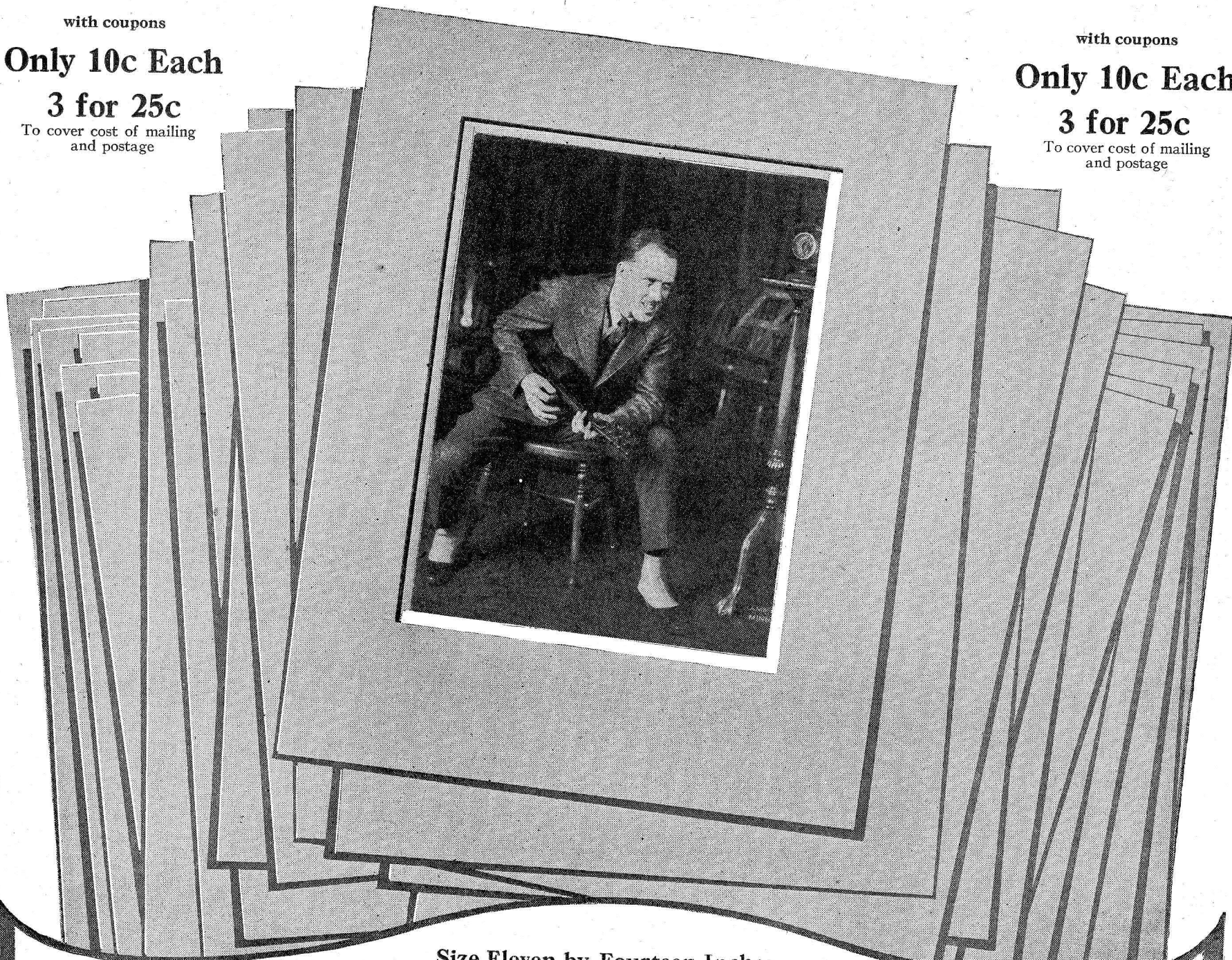

Size Eleven by Fourteen Inches

Select Your Favorites from the Gallery of Radio Stars

CHECK YOUR CHOICE

- Wendell Hall, king of ukulele ditties
- Graham McNamee, 1925 Gold Cup champion announcer
- Jack Little, popular wondering balladist
- Paul Small, who won fame through Radio
- Coon-Sanders "Nighthawks" at KYW
- George Hay, 1924 Gold Cup champion announcer
- Harmony Girls, Edith Carpenter, Grace Ingram of KYW
- Ford and Glenn, Lullaby Boys of WLS
- "Roxy" Rothafel of Capitol theater fame
- The Hired Hand, famous "Substitute Announcer" of WBAP
- Britt and Finch, popular songsters
- Bob Emery, Big Brother of WEEL
- "Bill" W. G. Hay, formerly of KFKX, Hastings, now WLIB
- Happiness Boys, jovial singers of WEA

CHECK YOUR CHOICE

- Lambdin Kay, "Little Colonel" of WSB
- Leo Fitzpatrick, "Merry Old Chief" of WDAF now at WJR
- Henry Field, Gold Cup runner-up of 1925
- Al Carney, organ favorite at WHT
- Aunt Jane, gives ladies advice at WOC
- Vincent Lopez Pennsylvania No. 1 orchestra at WEA
- E. L. Tyson, pleasing voice of WWJ
- S. W. Barnett, formerly of WOC now at WBAL
- Art Gilham, "The Whispering Pianist"
- Paul Greene, bridge expert and announcer at WSAI
- Harry Ehrhart, original "Dream Daddy" of WLIT
- Correll and Gosden of the "Kinky Kids Parade," WEBH.

CHECK YOUR CHOICE

- Norman Brokenshire well known through WRC, WJZ
- Indiana Male Quartet, popular harmonies at WEBH
- Jane Novak, Blues Singer of Twin Cities, WCCO
- Jean Sargent, the original Jean Sargent now at WHT
- Ralph Emerson, popular organist at WLS
- Edna Adams, "Sweetheart of the Air" at KPRC
- Pat Barnes, vaudeville announcer of WHT

If your favorites are not in this list send in a request to have them included in the Gallery of Radio Stars.

COUPON No. 1.

This coupon entitles the holder to one photogravure selected from the Radio Digest Gallery of Radio Stars when accompanied by ten cents to pay the cost of mailing and postage.

Three consecutively numbered coupons entitles the holder to three photogravures when accompanied by twenty-five cents.

RADIO DIGEST PUBLISHING CO.

ADVANCE PROGRAMS FOR THE WEEK

Saturday, December 26

Headliners Today

Eastern 8 p. m.	Central 7 p. m.	Mountain 6 p. m.	Pacific 5 p. m.
WCAE (461.3) Youngstown artists.			
WPI (394.5) "A Veil of Old Lace," play.	7:15	6:15	5:15
WIP (508.2) Look Out 1925—Revue.	8:30	7:30	6:30
WEAS (399.8) Barney Rapp's orchestra.			5:30
WCAE (461.5) WEEL (348.6), WJAR (305.9), WCAE (461.3), WSAI (325.9), WGR (319), WOC (483.6), KSD (545.1), WTAG (268), Chicquot Club Eskimos.			
WFI (394.5) Polish Christmas carols.			
WRC (468.5) Christmas in Ole Virginny.	10	9	8
WOC (483.6) Juvenile artists' program.	11	10	9
RNX (336.9) Special program.			
WSM (282.8) Tennessee Blue Grass serenaders.	11:10	10:10	9:10
KGQ (361.2) California quartet.	12 m.		
KPRC (298.9) Invisible choir, negro spirituals.			
WMCA (340.6) Maxine Brown and her pals.	2 a. m.	1 a. m.	12 m.
RNX (336.9) Filmland frolickers.			

Saturday, silent night for: CFAC, CFCA, CNRA, CNRC, CNRE, CNRM, CNRR, CNRT, CNRV, CNRW, KFDM, KFEQ, KFKX, KFMQ, KFMX, KFUD, KLX, KFDJ, KFMQ, KFXF, KMA, KOB, KSAC, KSO, KWCC, KTAB, WBAL, WBAP, WBZ, WCAD, WCAP, WCAU, WCX, WDD, WEAG, WEBJ, WEDW, WEI, WGGP, WGR, WHAD, WHAZ, WHB, WHN, WHQ, WIP, WIAR, WIJZ, WKAF, WKAR, WOI, WOS, WRVA, WSUI, WTAG, WTIC, WWJ.

Eastern Time Stations

OKAC, Montreal, Can. (411), 7:30 p. m., Windsor hotel dinner hour; 8:30, studio variety; 10:30, Windsor hotel dance program.

CKNC, Toronto, Can. (356.9), 4 p. m., string quartet, Charles Bodley, director; Elsie White, soprano.

CNRO, Ottawa, Can. (435), 7:30 p. m., cozy corner. Uncle Dick; 8, Chateau Laurier concert concert orchestra; Dora Villeneuve, pianist; St. Andrew's quartet; Agnes Mulligan, violinist; George White, tenor; S. J. Daly, reader; E. Hinchcliffe, contralto; Mrs. D. C. McDougall, soprano; Stafford Salmon, bass; Chateau Laurier dance orchestra.

PWJ, Havana, Cuba (400), 8:30 p. m., jazz band, Prof. Rogello Barba, director.

KDKA, Pittsburgh, Pa. (309.1), 7:15-8 a. m., exercises. O. Shannon; 5:45 p. m., Daddy Winkum; 6:30, dinner concert, Westinghouse band, T. J. Vastine, conductor; 8, farm program, National Stockman and Farmer studio; 8:30, Westinghouse band concert, T. J. Vastine, conductor; Herman Niebuhr, baritone.

WAHG, Richmond Hill, N. Y. (315.6), 12-12:15 p. m., Joe Zimmerman, pianist; 12-1 a. m., dance orchestra.

WBRR, New York, N. Y. (272.6), 8 p. m., Malcolm Carment, clarinetist; 8:10, L. Marion Brown, soprano; 8:20, Bible questions and answers, Judge Rutherford; 8:40, L. Marion Brown, soprano; 8:50, Malcolm Carment, clarinetist.

WCAE, Pittsburgh, Pa. (461.3), 3 p. m., music, Aldine theater; 6:30, dinner concert, William Penn hotel; 7:30, children's period; 8, Youngstown artists.

WCAP, Washington, D. C. (468.5), 6:45-7:45 a. m., Tower health exercises.

WCX, Detroit, Mich. (517), 6 p. m., dinner concert, Book-Cadillac hotel.

WEAF, New York, N. Y. (491.5), 4-5 p. m., the Louis Fisher orchestra; 6-7, the Tennessees dance orchestra; 7:30-7:45, "Sir Hobogoblin's Christmas Secret," Blanche Elizabeth Wade, story teller for G. R. Kinney company; 7:45-8:30, boys' band, St. Michael's Orphanage, direction of Rev. John J. West; 8:30-9, Nora Helms trio, Nora Helms, coloratura soprano; Sara Posselt, flutist; Edith Conner, harpist; 9-10, "Chicquot Club Eskimos," also through WEEL, WJAR, WCAE, WSAI, WGR, WOC, KSD, WTAG; 10-11, "Pop Concert"; 11-12, Vincent Lopez and his orchestra from Casa Lopez.

WEAR, Cleveland, Ohio (389.4), 11 a. m., home service talk; 7 p. m., Hotel Statler concert orchestra, Maurice Spitalny, director.

WFI, Philadelphia, Pa. (394.5), 10:15 a. m., reports; 10:30, solos; 10:40, home service talk; 1 p. m., Tea room ensemble; 3, Armand Jules Andre, pianist; Frank Paradowsky, violinist; W. Brooke Fryer, tenor; 6:30, Bellevue Stratford concert orchestra; 7, Bellevue Stratford dance orchestra; 8, play, "A Veil of Old Lace"; 8:30, Elba Saxophone Four; 9, Polish Christmas carols, Piotr Wiza; 9:45, cantata, "Behold the King," First Baptist church choir of Merchantville, N. J.; 10:30, Charles Abraham's dance orchestra.

WGSS, New York, N. Y. (315.6), 10-10:10 a. m., timely talks with Terese; 10:10-10:40, Cousin Eleanor and her kiddie klub program; 10:40-10:50, Serena Hutsall, Christmas reading; 10:50-11, fashion talk, Mme. Hall Deane; 1:30-1:35 p. m., Scripture reading; 1:35-2, Henrietta Menschner, pianist; 2-2:30, Montclair Seniors; 3-3:10, Ray Lev, pianist; 3:10-3:20, Philip Frank, violinist; 3:20-3:30, Ray Lev, pianist; 3:30-3:40, Philip Frank, violinist; 3:40-3:50, Ray Lev, pianist; 3:50-4, Philip Frank, violinist; 6-6:30, Uncle Geebee; 6:30-7, Vincent Sorey's concert trio; 7-7:10, ballroom dance instructions, Arthur Murray; 7:10-7:20, Chris Meehan, tenor; 9-10:30, Erbody's "Twin Oak" dance orchestra; 10:30-11:30, Arrowhead Inn orchestra.

WGCP, New York, N. Y. (252), 12:15-3 p. m., Mirror race results and latest sports items half hourly; 8-8:15, Henry Rogers, pianist; 8:15-8:30, Cross and Abraham's songs; 8:30-4:45, orchestra; 4:45-5, Sylvia Miller, soprano; Adelaide Kaiser, pianologue; 5-5:15, Rust and Henochsen, banjists; 8:30-9:30, studio program; 9:30-9:45, Ukulele Bob McDonald; 9:45-10, June Lee and Sammy Pain, entertainers; 10-11, Strickland's orchestra.

WGHB, Clearwater, Fla. (266), 6-7 p. m., Fenway hotel orchestra; 8:30-10, week-end revue, Carolina Lee, Bill Ewin, Edwin B. Dean, Mr. and Mrs. Charlie Waller; 11:45-1 a. m., midnight orchestra.

WGR, Buffalo, N. Y. (319), 2:30 p. m., WGR's afternoon program; 9, jointly with WEAF, Chicquot club company.

WGY, Schenectady, N. Y. (379.5), 7:45 p. m., bridge lesson, No. 4; 9:30, dance program; Reed Hamaker's Hotel Van Curler orchestra.

WHAR, Atlantic City, N. J. (275), 2 p. m., Seaside hotel trio; 7:30, lecture period; 8, Seaside hotel trio.

WHN, New York, N. Y. (361.2), 7:30-8 p. m., Monico club orchestra.

WIP, Philadelphia, Pa. (508.2), 6:45, 7, 10 a. m., exercises; 1 p. m., organ recital; 3, artists' recital; Charles Freiden, violin and saxophonist; Edward Springman, flutist and saxophone soloist; Kathryn Seary, ballad singer; Flora Ripka, accompanist; 6:05, dinner concert, Benjamin Franklin orchestra, W. Irving Oppenheim, director; 7, Uncle Wip's bedtime story, roll call; 8, sports corner, Dr. Francis D'Eliseu; 8:15, Look-out, 1925, Society's musical revue; 10:05, Benjamin Franklin dance orchestra, Howard Lanin, director; 11:05, organ recital, Germantown theater.

WJR, Pontiac, Mich. (517), 7 p. m., Jean Goldkette's Petite symphony orchestra, soloists; 9, Jean Goldkette's serenaders, soloists; 10, Jean Goldkette's Victor Recording orchestra; 11:30, Jewett Jesters, Merry Old Chief.

WJZ, New York, N. Y. (454.3), 1 p. m., Irwin Abrams' Knickerbocker orchestra; 1:30, Sherry's quartet; 3, Olga Dobos, soprano; Keith McLeod, accompanist;



The Sandman comes to WRC, Washington, D. C., ushered in by soft lullaby music from the skillful fingers of Gertrude Kreiselman, pianist. Sometimes Miss Kreiselman deserts the children to play the latest jazz for grownups.

3:20, announced; 4:05, Edwin J. Breen, baritone; Helen Wilcox, accompanist; 4:30, Hotel Lorraine grill orchestra; 7, Bernhard Levitov's Hotel Commodore orchestra; 8, "Radio Novel," Cosmo Hamilton; 8:15, Keith McLeod, pianist; 8:30, Sherry's dance orchestra; 9:15, Hotel Madison concert orchestra; 10, announced; 10:30, Paul Specht's Moulin Rouge orchestra.

WLIT, Philadelphia, Pa. (394.5), 12:02 p. m., daily almanac; Stanley theater organ recital; Arcadia cafe concert orchestra; 2, Arcadia cafe concert orchestra; 4:30, Ed Matthew's dance orchestra; 7:30, organ recital; Benjamin Franklin concert orchestra.

WMAK, Buffalo, N. Y. (266), 7:30-9 p. m., musicale; 9-10, program, Sunrise Point Development company.

WMCA, New York, N. Y. (340.6), 6-6:30 p. m., Olcott

High Lights of the Week

FANS WHO enjoy light opera music will tune, in for WIP, Philadelphia, Saturday night for the "Look-Out 1925 Revue" staged by Sigmond Romberg, the composer of "The Student Prince." Although the lovely costumes may not be seen, the music of this composer has a lyric quality which makes it very popular. WFI, also of Philadelphia, is scheduling a fine program for this evening with three headliners "A Veil of Old Lace," Polish Christmas carols, and a cantata, "Behold the King."

Handel's famous oratorio, "The Messiah," will find its way out over the ether from many stations this year. One group to sing this music will be the Messiah club of KLDS, Independence, Mo. The performance, which is an annual event, will be broadcast Sunday evening. The Sunday Symphonic society conducted by Josiah Zuro will give an unusually fine program Sunday afternoon at WJZ.

Ralph is a favorite name for announcers at KOA, Denver. The three, Ralph Crowder, Ralph Freese and Ralph Clark, will give a comedy skit Monday, taking off themselves. The lyric tenor tones of Adolpho Jimenez, a well-known Spanish singer, will float upon the ether this same evening from KPRC.

The long hair of many poets, if modern poets have long hair, will be hidden behind the microphone of WTIC, Hartford, Tuesday night when

the Hartford Poetry club takes to the air. At WBAL, Baltimore, this same evening, the Orpheus male quartet makes its Radio debut.

"Which Shall It Be—Serge or Satin?" the eternal feminine question asked by women, will be answered by Alma Fritchhoff Wednesday night in her fifth lecture on costume design. If you prefer something less serious in tone, tune in for the Jewett Jesters with the Merry Old Chief presiding.

For the first time in the history of broadcasting, the liberty bell which hangs in a glass-enclosed case in Independence hall, Philadelphia, will be put on the air through Station WIP, and perhaps other stations, to ring out the old year and ring in the new. Mrs. W. Freeland Kendrick, wife of the mayor of Philadelphia, will tap the bell with a specially constructed mallet. New Year's eve promises a fine birthday party at KTMS. This station is one year old. Among the other stations celebrating the ending of the old year with special programs are KHJ, with the passing Radio revue of 1925, and WAHG with special organ music.

New Radio sets may be enjoyed all day Friday by ambitious fans. The Victor hour of music begins at WJZ, WRC, WGY and WBZ. The Hoot Owls of KGW, the Morning Glory club of WLIT, and other stations with regular Friday features are planning gala programs.

Vail and his Hotel McAlpin string ensemble; 6:30-7, Robert Soffer, pianist; 7-7:05, Hugo Zeller, talk on lacquer; 7:05-8, the Amphions dance orchestra; 8-8:30, current events outline; 8:30-8:50, Xenia Wasson, soprano; 9:30-10, Cinderella dance orchestra; 10-10:30, Nichols trio; 10:30-11, Mario Alvarez, tenor; 11-12, Ernie Golden and his Hotel McAlpin orchestra; 12-1 a. m., Maxine Brown and her pals.

WNYC, New York, N. Y. (526), 7:30 p. m., dance programs; 7:35-8, dance program; 8-9, studio concert; 9-9:30, instrumental novelties; 9:30-10, male quartet; 10:10-10:30, "Turkish Life and Customs," Summazeh Attiyeh.

WOO, Philadelphia, Pa. (308.2), 11 a. m., organ recital; 12, Golden's Crystal tea room orchestra; 4:45, organ recital; 7:30, Hotel Adelphia French room orchestra.

WOR, Newark, N. J. (405.2), 8-1 p. m., Ziti's Central Park Casino orchestra; 6:15-6:25, words often mispronounced; 6:25-6:37, sport talk, Bill Wathey; 6:37-7:30, Jacques Jacobs' Hotel Shelton ensemble; 7:30-8, Van's Collegians; 11:30-12, Crystal Palace orchestra.

WRC, Washington, D. C. (468.5), 12 noon, organ recital, Homer L. Kitt studios; 1 p. m., Hamilton hotel orchestra; 6, Lee House trio; 7, Hotel Washington orchestra; 8:10, Bible talk; 8:30, music; 9, "Christmas in Ole Virginny," W. Alfred Falconer; 10:30, Crandell's Saturday Nighters; 12-1 a. m., Spanish Village orchestra.

WREO, Lansing, Mich. (285.5), 6-7 p. m., dinner concert, Speed-Wagon serenaders; Gold Standard ensemble; 10-12, special dance program; Speed-Wagon serenaders; Carl Hall Dewey, director.

WTAG, Worcester, Mass. (268), 10:30 a. m., miscellaneous program; 12:05-2 p. m., luncheon music, WTAG orchestra, Will Hardy, director; 5:15, Twinkle Twinkle story teller.

WTAM, Cleveland, Ohio (389.4), 12:15-1:15 p. m., lunch hour music, popular entertainers; 6-7, dinner music, Hotel Hollenden orchestra, Carl Rupp, director; 8-9, miscellaneous program; 9-12, novelty program; Ev Jones and the Coo Coo club; selected artists.

WWJ, Detroit, Mich. (352.7), 9:30 a. m., "Tonight's Dinner"; 12:05 p. m., Jules Klein's Hotel Statler orchestra; 3, Detroit News orchestra.

Central Time Stations

KFAB, Lincoln, Nebr. (340.7), 5:30-6:30 p. m., dinner hour concert, Belshaw's orchestra, Buick little symphony; 8:30-10:30, Schmoller and Mueller musicale.

KFEQ, Oak, Nebr. (268), 2-3 p. m., King's entertainers.

KFKX, Hastings, Nebr. (288.3), 3:30 p. m., dinner concert, KDKA.

KFNF, Shenandoah, Iowa (266), 7 p. m., accordion contest; 7:30, concert, Widney sisters.

KFVE, University City, Mo. (240), 9:15 p. m., amusement review, Romaine Fielding; dance numbers, Gene Witacker's orchestra.

KLDS, Independence, Mo. (441), 8 p. m., popular program, Irene Bowman, organist; Mrs. E. N. Brinkman, contralto; E. N. Brinkman, bass; Mrs. Paul Cantrell, soprano.

KMA, Shenandoah, Iowa (252), 11:20-12:30 p. m., rural program; 12 m., domestic science, Juna B. Case; 6-7, Pollyanna stories, Mrs. Dwight Nickols; 9-11, William Howie, organist.

KOL, Council Bluffs, Iowa (278), 5-6:30 p. m., Randall's Royal Fontenelle orchestra; 5:30-6, McCrory's popular music period; 6:15-6:30, "Your House and Its Decoration," Fern Daily; 6:30-7, Randall's Royal Fontenelle orchestra; 7-7:15, "What's Doing in Town Tonight?"; 7:15-7:30, educational period, U. of Omaha; 7:30-9, program, D. Christy; Christy trio; C. H. Amick, reader; Vallerie Christy, violinist; Mrs. J. Thorson, vocalist; 11-12, Hugo Heyn and his Happy Hollow club orchestra; 12-1 a. m., Randall's Royal Fontenelle orchestra; 2-3, Pacific Coast program.

KPR, Houston, Tex. (296.9), 12 noon, Jack Willrich's orchestra, McMillian's Dancing academy; Virginia Willrich, accordionist; E. W. Rodgers, vocalist; 12:30 p. m., health talk, Dr. A. H. Flickwir; 7:30, Universal Bible class, Rev. Claude Jones; 8, Frank Tilton, pianist; 11, St. James Methodist church invisible choir (colored); real negro spirituals.

KSD, St. Louis, Mo. (545.1), 7 p. m., orchestral program, stage specialties, Missouri theater.

KTMS, Hot Springs National Park, Ark. (374.8), 9-9:30 p. m., Graham male quartet, negro spiritual and secular songs; 9:30-9:35, bedside story; 9:55-10:30, dance folic, Meyer Street orchestra.

KYW, Chicago, Ill. (535.4), 11:35 a. m., table talk, Mrs. Anna J. Peterson; 12:05-1 p. m., noonday concert, Commonwealth Edison company; 1-2, Congress hotel, Coon-Sanders Original Nighthawks; 6-6:10, news; 6:10-6:40, music, Commonwealth Edison company; 6:40-7, children's bedtime story, Uncle Bob; 7-7:30, Congress hotel; 7:30-8:30, home-lovers' hour; 8:30-10:30, classic, Edwin Borroff, director; 11-1, Congress carnival; 1-2, Insomnia club, Coon-Sanders Original Nighthawks.

WAMD, Minneapolis, Minn. (243.8), 12 m., musical program, Marion Latta, contralto; Norvy Mulligan, pianist; 7:05 p. m., popular musical program; Harmony twins; Adeline Wagner, soprano; Robert Davis, tenor; Wayne Hugaboom, accompanist; 11, Skyrocket frolic, George Osborn's Hotel Radisson Skyrockets.

WBBM, Chicago, Ill. (226), 4-6 p. m., Valentino Inn orchestra; Harry Sosnick, Sandy Meek; 8-9:30, Moulth Rouge orchestra; Burdette Cleveland, pianist; Charlie Garland, Nate Caldwell, Jordan and Jeske; 9:30-11, Merry Garden orchestra; 11-1, Sunset male quartet; Stewart-Warner string quartet; Montmartre orchestra; Lew Russell, George Marbach, tenor; Leona Hayes, harpist; 1 a. m., program.

WBCN, Chicago, Ill. (266), 10-10:30 a. m., shopping talk, Penny Wise; 3-5 p. m., tea time matinee; Clarence Jones, pianist and song writer; Cecile and Johanna Arends, violinist and pianist; Marie Wright, soprano; 10-11:15, jazz jamboree, Midway Dancing Gardens orchestra; Cameron and Fett. "The Harmony Wizards," harmony duo; Albert Blaha, concertinist; Johnny Smeal, the harmonica acrobat; Elizabeth Emmett Malone, soprano; Jack Parker, tenor; 11:15-12, King Statie's court; Frank H. McDonald, "King Statie"; Mary Williams, "Queen Olive"; Harry A. Zook, Jr., "Prime Minister"; "Big Boy" Yagle, "Court Jester."

WCCO, Minneapolis-St. Paul, Minn. (416.4), 12:30 p. m., concert, Golden Pheasant orchestra; 2:30, afternoon concert; 6:15, concert, Biley's St. Paul hotel orchestra; 8, "Fireside Philosophies," Rev. Roy L. Smith; 8:15, musical program; 10:05, dance program, Arnold Frank's St. Paul hotel orchestra.

WDAF, Kansas City, Mo. (365.6), 3:30-4:30 p. m., Star's string trio; 6-7, address, Roger W. Babson; organ music, Trueman ensemble; 11:45-1, Plantation players, Johnnie Campbell's Kansas City club orchestra; Earl Coleman's orchestra; Eddie Kuhn's Kansas City Athletic club orchestra.

WENR, Chicago, Ill. (266), 6-7 p. m., dinner concert; Rauland lyric trio; vocal solos; George Unger, violinist; R. Hendrickson, cellist; 8-10, popular program; All-American Pioneers, Art Bilquist, popular songs; Walter Peterson and Al Tweed, harmonica and guitar duets; Floyd Falch; John Papa, concertinist; 12-2 a. m., All-American Pioneers; Rita McFawn, Mary Bieber, vocal duetists; Al Tweed and Walter Peterson; Art Bilquist.

WFAA, Dallas, Tex. (475.9), 12:30-1 p. m., "The Message of Christmas," Dr. J. B. Cranfill; 6:30-7:30, Don Bestor's Bests, orchestra; 8:30-9:30, Mrs. A. Smith, soprano; musicians; 11-12, Jack Gardner's orchestra.

WGES, Oak Park, Ill. (250), 5-7 p. m., Roynterson sisters; Ida Weltman; Edith E. Hoffman, soprano; Ray Bush, tenor; Pietro Marchi, tenor; 8-9, Doc Berendson and his Tiffin orchestra; W. Remington Welch, organist; Lyman Gurney, tenor; Gus Edwards and his jazz band; Lola May, Girls vocal trio; Gene Baumgardner, violinist; 11-1, Lea May Girls; Gus C. Edwards and his jazz band; W. Remington Welch, organist; Sandy McFavish, Scotch comedian; Edith Adams and her uke; Irwin Schmidt, Stella Stanley and Annette Bennette.

WIP STAGES "LOOK-OUT 1925 REVUE"



Radio favorites may come and go but Marie Keiny, left has been popular at WOA W for three years. She is the staff pianist and hostess. To the right is Wanda Kraser, pianist, who will appear Tuesday at KGO, Oakland, California.

KFON, Long Beach, Calif. (232.4), 4:30-5 p. m., amusement bulletin; 6-8:30, organ recital, Brayton's theater; 7:30-9, Long Beach Municipal band; 9-11, Echophone entertainers frolic.

KFWB, Hollywood, Calif. (252), 7:45 p. m., microphone brevities; 8-10, Radio doings reveals with Bill Blake, tenor; Emma Kimmel, soprano; Hollywood string trio and technical Radio talks; 10-11, Warner Brothers frolic, direction Charlie Wellman; 11-12, Hollywood Roof ballroom orchestra.

KGO, Oakland, Calif. (361.2), 7:15-7:30 a. m., health training exercises, Hugh Barrett Dobbs; 7:45, pep class; 8:15-8:30, training exercises; 11:30-1 p. m., luncheon concert; 4-5:30, concert orchestra, Hotel St. Francis, Vinton LaFerrera, conductor; 8, sport review, Al Santoro; 8:10, Arion trio; California mixed quartet; Josephine Holub, violinist; Margaret Avery, cellist; Joyce Holloway Barthelsson, pianist; Zilpha Jenkins, soprano; Ruth Waterman, contralto; Carl Anderson, tenor; Albert Gillette, bass; Howard Milholland, reader; 10-12, dance music program, Hotel St. Francis.

KGW, Portland, Ore. (491.5), 12:30-1:30 p. m., Rose City trio; 6-7, dinner concert; 9-12, dance music, Indian Grill.

KHJ, Los Angeles, Calif. (405.2), 6-6:30 p. m., Leighton's Arcade cafeteria orchestra, Jack Cronshaw, leader; 6:30-7:30, history story, Professor Hertzog; Dollie of Badoland; Henrietta Poland, readings; Elma Savery, pianist; 8-10, program, Los Angeles Soap company, presenting the first of two nights of chamber music; 10-11, Don Clark's Biltmore hotel dance orchestra.

KMTR, Hollywood, Calif. (238), 6-7 p. m., Starr Piano company studio; 8-10, Turner orchestra, Loren Powell, director.

KNX, Hollywood, Calif. (336.9), 5-5:30 p. m., Sunny Jim's talk to children; 5:30-6:15, Wurlitzer pipe organ studio; Town Tattler; 6:15, travel talk, W. F. Alder; 6:30-7, Atwater Kent concert orchestra, Paul Einstein, leader; 7, talk on insect life, H. W. McSpadden; 7:15, church announcements; 7:30-8, Wurlitzer pipe organ studio; 8-10, program, Commercial Construction company, Calmon Luboviski, concert violinist; Edward Murphey and his players and Sol Hoopii's Hawaiians; 10-11, Ray West's Coconut Grove dance orchestra from Ambassador hotel; 11-2 a. m., Filmland Frolickers, direction Chet Boone.

KPO, San Francisco, Calif. (428.3), 7, 7:30, 8 a. m., daily dozen exercises; 1-2 p. m., Rudy Seiger's Fairmont hotel orchestra; 2:30, popular musical program, Frank Taylor's El Camino orchestra; 3:30, Palace hotel concert orchestra, Cyrus Trobpe, director; 6:35-7:30, Waldemar Lind and the States restaurant orchestra; 8-12, Cabraria cafe orchestra, Jack Cookley, director.

KPSN, Pasadena, Calif. (315.6), 8-9:30 p. m., studio program; 9:30-10:30, dance orchestra, Hotel Maryland.

KTAB, Oakland, Calif. (240), 9-9:30 a. m., prayer service, Rev. E. L. Spaulding.

WGHB, WHAD, WHAS, WHAZ, WIP, WJAZ, WJJD, WKAF, WKAR, WMAQ, WMC, WNYC, WOI, WOR, WRC, WRVA, WSAI, WTAM.

Eastern Time Stations

CFCA, Toronto, Can. (356), 11 a. m., service, St. Paul's Anglican church; 7 p. m., service, Walmer Road Baptist church, Dr. John MacNeill, preacher.

CHIC, Toronto, Can. (356.9), 5 p. m., organ recital, George H. Graham.

CKAC, Montreal, Can. (411), 2:45 p. m., Capitol theater hour, special Christmas entertainment.

KDKA, Pittsburgh, Pa. (309.1), 11 a. m., church service; 4 p. m., organ recital, Dr. Charles Heinroth; 4:45, vesper service, Shady-side Presbyterian church; 6:30, dinner concert; 7:45, services.

WBAL, Baltimore, Md. (375), 6:30-7:30 p. m., twilight program; concert orchestra, Christmas music, Gustav Klemm, conductor.

WBZ, Springfield, Mass. (333.1), 10:45 a. m., services, Church of the Unity, Rev. Charles Wing, pastor; Philharmonic quartet; Robert W. Field, organist and director; 7, dinner concert, Copely Plaza orchestra, W. Edward Boyle, director; 8, talk, "Human Motives," Dr. Abraham Myerson.

WCAP, Washington, D. C. (468.5), 11 a. m., service, Epworth M. E. church, Rev. John Paul Tyler, pastor; 4 p. m., services, Bethlehem chapel, Rev. James E. Freeman; 7:20-9:15, musical program, Capitol Family, WEAF; 9:15-10:15, Atwater Kent hour, WEAF; Rosa Low, soprano; Benjamin Gigli, tenor.

WCAE, Philadelphia, Pa. (277.6), 5:20 p. m., Robert Fraser, blind gospel singer; Elizabeth Holtz, pianist; 5:35, Undenominational church service, Rev. John W. Stockwell, pastor; 5:45, "Every Good Thing Comes from Genesis," Reverend Stockwell; 5:55, recital; 6:05, "One Glance Backward and Two Glances Ahead for the New Year," Rev. John W. Stockwell; 6:45, Clarence Seaman and his Hotel Pennsylvania orchestra; 7:45, Cathay concert orchestra; 6:30, Bonwit-Teller light opera company; 9, Potash and Perlmutter.

WCX, Detroit, Mich. (517), 10:30 a. m., services, Central Methodist Episcopal church.

WEAF, New York, N. Y. (431.5), 2-3 p. m., Sunday Radio service, auspices of Greater New York Federation of Churches, Dr. William B. Miller; Lotta Madden, soprano; Mildred Bryars, contralto; Louis Caton, tenor; Arthur Billings, Hunt, baritone; George Shackley, pianist; 3-3:45, Young Peoples conference, talk, "What Is Success," Dr. Daniel A. Poling; 3:45-5:30, men's conference, Bedford branch of Y. M. C. A., Brooklyn, N. Y., also through WEEL, WTAG, WCAE, WSAI; 7:20-9:15, musical program, Major Edward Bowes and the Capitol family; also through WEEL, WCAP, WJAR, WTAG, WVV, WCAE, KSD; 9:15-10:15 p. m., "Atwater Kent Radio Hour," also through WGR, WEEL, WCAP, WJAR, WCAE, WSAI, WVV, WOC, WCCO, WTAG, KSD, WEAR, WLIB.

WEEL, Boston, Mass. (348.6), 10:50 a. m., morning service, Old South church; 2:30 p. m., Chamber of Commerce organ recital; 3:45, Dr. S. Parkes Cadman, and WEAF; 7:20, Major Bowes and his Capitol theater family, WEAF; 9:15, Atwater Kent Radio hour, WEAF.

WFI, Philadelphia, Pa. (394.5), 4:30 p. m., chapel services, sermon by Rev. Wm. L. McCormick.

WGSS, New York, N. Y. (315.6), 9:30-10 p. m., American women's quartet; 10-10:30, St. Cecilia Woodwind ensemble.

WGCP, New York, N. Y. (252), 7-7:30 p. m., orchestra; 7:30-7:45, Dick's Ukulele club; 7:45-8, Charlotte Trystmann, pianist; 8-8:05, health talk; 8:05-8:15, Milton Yokeman, tenor; 8:15-8:45, Bernard Share, violinist; Harry Retskin, pianist; 8:45-9, Isabelle Henderson, soprano; 9-9:30, Strickland's orchestra.

WGR, Buffalo, N. Y. (319), 3 p. m., vesper service, Buffalo council of churches; 7:45, Central Presbyterian church service; 9:15, jointly with WEAF, Atwater Kent Radio hour.

WGY, Schenectady, N. Y. (379.5), 11 a. m., services, First Reformed church, Rev. Clayton Potter, pastor; 3 p. m., program, Syracuse, N. Y.; 7, Carillon program, Park Avenue Baptist church, WJZ; 7:30, service, First Presbyterian church; 9, WJZ studio program; 10, Godfrey Ludlow, violinist, WJZ.

WJAR, Atlantic City, N. J. (275), 10:45 a. m., morning service, Chelsea Baptist church; 2:15 p. m., sacred recital, Seaside hotel trio; 2:45, sermon, Louis E. Wein; 7:50, Chelsea Baptist church; 9, "An Hour with the Classics," Seaside hotel quartet; 11:15, Strand theater organ recital.

WHN, New York, N. Y. (361.2), 12:30-1 p. m., Lexington organ recital; 2-3, Queens County Christian Endeavor program; 3-4:30, Calvary Baptist church services; 5-5:30, Roseland dance orchestra; 7:30-9:45, Calvary Baptist church; 10:45-11:15, Janssen's orchestra; 12-12:30 a. m., Harry Richman and his entertainers.

WIP, Philadelphia, Pa. (508.2), 10:45 a. m., services, Holy Trinity church, Rev. Floyd W. Tomkins, D. D.; 4, "The Golden Age," Dr. Alexander Cairns.

WJZ, New York, N. Y. (454.3), 12:30-2 p. m., Sunday Symphonic society, Josiah Zuro, conductor; 8:15-9:30, American orchestral concert, Chalmers Clifton, conductor.

WLIT, Philadelphia, Pa. (394.5), 2 p. m., Arcadia cafe concert orchestra; 7:30, Chamber Music society concert.

WMCA, New York, N. Y. (340.6), 11 a. m.-12:15 p. m., services, Fourth Church of Christ, Scientist, of New York; 6-7, Roemer's Homers; 7-8, Ernie Golden and his Hal McAlpin orchestra; 8-8:15, talk on lacquer, Hugo Zeller; 10:30-10:50, Burrows Johnson, Radio engineer; 10:50-11:15, Daren orchestra.

WOO, Philadelphia, Pa. (508.2), 2:30 p. m., Sunday school exercises, Bethany temple; 6, organ recital, Clarence Bawden; 7:30, services, Bethany temple; 9, Atwater Kent, WEAF.

WREO, Lansing, Mich. (285.5), 10 a. m., chimes; 10:30, services, First Baptist church, Ralph W. Hobbs, pastor; 7 p. m., services, Central M. E. church, Rev. Frank Kingdon, pastor.

WTAG, Worcester, Mass. (268), 4-5:30 p. m., Men's conference, Dr. S. Parkes Cadman, WEAF; Gloria trumpeters, George Betts, chime soloist; 7:20-9:15, Major Edward Bowes and the Capitol family; 9:15-10:15, Atwater Kent hour.

WTIC, Hartford, Conn. (475.9), 8:15 p. m., concert, New York string quartet; Esther Dale, soprano.

WWJ, Detroit, Mich. (352.7), 11 a. m., services, St. Paul's Episcopal cathedral; 2 p. m., Detroit News orchestra; 7:20, Capitol theater gang; 9:15, Atwater Kent artists.

Saturday, December 26

WGN, Chicago, Ill. (302.8), 7 a. m., setting-up exercises; 11-11:30, Sally Joy Brown; 11:30-12 noon, fashion facts and fancies; 12-12:40 p. m., household hints; 12:40-2:30, Drake concert ensemble, Blackstone string quintet; 2:30-3, Lyon and Healy artist series; 3-3:30, public service; 3:30-4:15, tea time music, Marshall Field tea room orchestra; 4:30-5, Edward Benedict, organist; 5:30-5:57, children's program; 6:30-7, Drake concert ensemble, Blackstone string quintet; 8-9, Drake concert ensemble, artists; 10-11, Jack Chapman's orchestra, Blackstone hotel dance orchestra.

WHAD, Milwaukee, Wis. (275), 11 a. m., pianolog, Andy Hertel; story for children, Faye McBeath; Margaret Cunningham, pianist; Willard Kaleibe, tenor banjo soloist.

WHAS, Louisville, Ky. (399.8), 4-5 p. m., musical program, Harry S. Currie, director; Leroy Hobb, baritone; Martha Pope Robinson, reader; readings; 7:30-9, concert, Barney Rapp's orchestra.

WHT, Chicago, Ill. (399.8), 10 a. m., Jean Sargent's woman's club, Jelke Good Luck Girl; 11, special studio features; 12 m., Al Carney's organ hour; 1-2 p. m., special studio features; 6, final football scores, classical program, dinner organ recital; Graylia's string trio; Eleanor Kaplan, violinist; Estell Stanley, soprano; Antoinette Bennett; W. A. Dyckman, baritone; Florence White Rush, soprano; 7:45-9:15 (238), musical features; 9:30 (399.8), Jelke entertainers, Kitchen Klezzer Classics; Harry Langdon, harmonica; Marie Wright, soprano; the Golden trio, Oscar Heather, tenor; Al Carney, organist; Badger Four male quartet, Clark Hawaiian trio, Vic Fredericks, baritone; Irene Beasley, "The Girl from Dixie"; Marguerite Morris, "The Girl from Georgia"; Jacobson, humorist; 12, Pat Barnes and Al Carney.

WIBO, Chicago, Ill. (226), 2-4 p. m., shut-in program, Jack Sprat and the Carl Sulzer orchestra; Ted Florito, piano; Victor Young and Dan Russo, violinist; Vernon Hayes, saxophonist; 6-8, Walter Preston, request night, Eugene Wallentis, tenor; Frances Schieb, soprano, Ruth Buhl Flock, reader; old-fashioned trio; male quartet.

WKRC, Cincinnati, Ohio (422.3), 10 p. m., Marion McKay and his orchestra; 10:30, studio features; 10:45, Marion McKay and his orchestra.

WLIB, Chicago, Ill. (302.8), 7-8 p. m., dinner concert; 9-10, Fred Hamm and his Liberty orchestra; 11-12, Jack Chapman's and Blackstone hotel dance orchestras.

WLS, Chicago, Ill. (344.6), 7 p. m., lullaby time; 7:15-12, WLS national barn dance program; WLS Cornhuskers; WLS barn dance trio; Maurie Sherman's Bal Tabarin orchestra; Ford and Glenn; Ralph Emerson, organist.

WLW, Cincinnati, Ohio (422.3), 7 p. m., organ concert, Johanna Grosse; 7:40, Seketary Hawkins; 9, popular dance music, Castle Farm.

WMAQ, Chicago, Ill. (447.5), 6 p. m., Chicago theater organ; 8:30, Hotel LaSalle orchestra; 8, Frederick Daw and Russell Pratt; 8:30, "The Holy Land," photographer; Dr. Shailer Mathews; 9, Chicago theater revue.

WMBB, Chicago, Ill. (250), 7-8 p. m., Trianon duo, Ralph E. Elliott; 9-11, Trianon orchestra; Woodlawn theater orchestra; Lionel Carter, Scotty Welsh, Madison Sisters; Tracy and Duncan.

WMC, Memphis, Tenn. (499.7), 7:15 p. m., bedtime stories; 8:30, studio musicale.

WOAW, Omaha, Nebr. (526), 6 p. m., Sandman's visit; 6:20, Rialto orchestra; 7, after-dinner hour, sport talk, Ivan L. Gaddis; 9, Omaha Printing company; 10:30, Frank Hodek and his Nightingale orchestra; 11, Arthur Hays and his organ jubilee.

WOC, Davenport, Iowa (483.6), 5:45-6 p. m., chimes; 6:30-6:50, Sandman; 9-9:30, auction bridge, WEAF; 11-12, LeClair hotel orchestra; Peter MacArthur, baritone.

WOI, Iowa City, Iowa (270), 12:30 p. m., chimes; 12:45, soil problems, Prof. W. H. Stevenson.

WOK, Chicago, Ill. (217.3), 1-2 a. m., Tierney's Town club orchestra; Husk O'Hare's Coconut Grove orchestra; Harriet Lee, contralto; Herman Sinaiko, violinist; George Allen, tenor; Bob Mokreis, pianist; 6 p. m.-1:30 a. m., Gus C. Edwards and his orchestra; Husk O'Hare's Coconut Grove orchestra; Tierney's Town club orchestra; Capitol theater musical program; WOK mixed quartet; Herman Sinaiko, violinist; Harriet Lee, contralto; George Allen, tenor; Bob Mokreis, pianist; Bill Hay, bass.

WOO, Kansas City, Mo. (278), 8-9 p. m., musical program; 10-11, musical healing service.

WQJ, Chicago, Ill. (447.5), 11 a. m.-12 noon, "Looking Glass Reflections at Home," Marjorie Curry; "Better Diction," Mme. Peggy Right; character readings, F. E. Ormsby; 3-4 p. m., special kaffe klatsch, Jerry Sullivan, Rose Vanderbosch, Hal Lansing; 7-8, Ralph Williams and his Rainbo Gardens orchestra; Shepard Levine, tenor; Helen Reed, accompanist; Kane McDuffee, whistler; Lavina Price, pianist; Ralph Kelm, pianist; Anne Keim, mezzo-soprano; 10-3, Ralph Williams and his Rainbo Skylarks; Dr. Carl Bertschinger, pianist; Jerry Sullivan; Rose Vanderbosch, soprano; Hal Lansing, ukulele soloist; Everett George, organ, reader; Bert Davis, Clown of the Air; Clarence Theaders, tenor; Rita McPaw, Mary Bieber, harmony trio; George Thurn, kazoo soloist; Anita Chellis, comedienne; Joey Stool, tenor; Eddie Vogel, baritone; Brundage and Kraemer, harmony singers; Thelma Pefferle, soprano.

WSAI, Cincinnati, Ohio (326), 7:45 p. m., children's stories, Mrs. Ethel Knapp Behrm; 8, chimes, Robert Badgley; 8:15, Bicycle Playing Card sextet; 9, U. S. Playing Card news review, events, Allison F. Stanley.

WSM, Nashville, Tenn. (282.8), 6:30 p. m., Francis Craig and his orchestra; 7, bedtime story interlude; 8, Uncle Jimmy Thompson; Eva Thompson Jones, contralto; 10, Gallatin, Tennessee Blue Grass serenaders.

Mountain Time Stations

KOA, Denver, Colo. (322.4), 12:15 p. m., Rialto theater musicale; 9, Wurlitzbach's orchestra.

KFWA, Ogden, Utah (261), 4-5 p. m., organ recital, Paramount theater; 5-6, Ogden Radio Dealers program; 9-10:30, dance music, Otto Reeves and his orchestra.

Pacific Time Stations

KFOA, Seattle, Wash. (454.3), 8:30-9:30 p. m., program; 9:30-11:30, Eddie Harkness and his orchestra.



Sunday, December 27

Eastern 7 p. m.

WBZ (333.1) Dinner concert.

WJZ (454.3) WGY (379.5) Carillon program, 7:30 5:30 4:30

WLIT (394.5) Chamber Music society concert, 8:15 7:15 6:15 5:15

WJZ (454.3) American orchestral concert.

WTIC (475.9) New York string quartet, 8 7 6

KLDS (440.9) Handel's "Messiah," 9:15 8:15 7:15 6:15

WEAF (491.5), WEEL (348.6), WGR (319), WCAE (461.3), WCAP (468.5), WJAR (305.9), WTAG (268), KSD (545.1), WCCO (416.4), WOC (483.6), WFI (394.5), WLIB (302.8), WSAI (326) Atwater Kent hour, 9:30 8:30 7:30 6:30

WLW (422.3) Pogue company concert, 9 8 7

KTHS (374.8) Classic hour, 10:45 9:45 8:45 7:45

WOC (483.6) Palmer little symphony, 11 10 9 8

KHJ (405.2) Second night of chamber music, 12 m. 11 10 9

KNX (336.9) Sunday night classical hour.

Sunday, silent night for: CFAC, CKNC, CNRA, CNRC, CNRE, CNRM, CNRO, CNRR, CNRT, CNRV, CNRW, KFAB, KFAD, KFPI, KFXX, KFMO, KFOA, KFVE, KFWA, KMA, KMTR, KOE, KSAC, KSO, KWSC, FWX, WAHG, WBAP, WCAF, WCAU, WCX, WDAF, WEAQ, WEBJ, WEBW, WFI, WGES, WGPC.

HANDEL'S 'MESSIAH' SUNDAY AT KLDS

Sunday, December 27

Doing in Our Town Tonight? 7:15-7:30, Sleepy Time Girl, Bernice Clizbe; 7:30-9, Monarchs, Jerry McMillen, director; talk; 11-12, College club orchestra.

KPRC, Houston, Tex. (296.9), 10:45 a. m., services, First Christian church, Rev. Claude Jones, pastor; Guy E. Curtis, director; W. P. Claypool, organist; 7:30 p. m., services, South Main Baptist church, Rev. M. Wolf, pastor; E. P. McClanahan, director; 9:30, special Sunday evening concert.

KSD, St. Louis, Mo. (545.1), 6:15 p. m., WEAF chain.

KTHS, Hot Springs National Park, Ark. (374.8), 11-12:15 p. m., services, Central Methodist church; 9-10, classic hour, American composers, New Arlington hotel-Meyer Davis grand ensemble; 10-11:30, frolic, Benny Ford's DeSoto orchestra.

KYW, Chicago, Ill. (535.4), 11 a. m., Central church services, Rev. Frederick P. Shannon, pastor; 2:30 p. m., studio chapel services; 4:30, studio concert, Edwin Harper, director; 7, Chicago Sunday Evening club services, Clifford Barnes, president; music, Edgar Nelson, director; Bishop Thomas Nicholson, Methodist Episcopal church, speaker; 9:30, classical concert, Commonwealth Edison company.

WAMD, Minneapolis, Minn. (243.8), 7:05 p. m., Arthur H. Faust; 9:30, Gayle Wood, harmony hurricane.

WBBM, Chicago, Ill. (226), 12:30-2 p. m., classical program, Edna Wheeler Ballard, harpist; Harry Sosnik and Sandy Meek; Moulin Rouge quartet; 4-6, Ziegler sisters; Jack Garcia, Hawaiian guitarist; Harold Anderson, accordionist; orchestra; Lew Russell, xylophone trio; Tip trio; 8-10, Phillip Niles, tenor; Sunset quartet; Moulin Rouge orchestra; 12-2 a. m., Nutty club; Moulin Rouge orchestra.

WBCN, Chicago, Ill. (266), 10:30 a. m.-12 noon, morning services, People's Liberal church; talk, Rev. Rufus A. White; 4-5 p. m., Dain & Son classical hour; Velma Cook, soprano; Oriental quartet; male harmony group; Robert Stronach, pipe organist; 7:45-9:15, evening services, Thoburn M. E. church, 40-piece Thoburn semi-symphony orchestra; 80-voice choir, special vocal soloists; speaker.

WCBF, Zion, Ill. (344.6), 8 p. m., mixed quartet, male chorus, celestial bells; Hiro trio; Edith Carey, contralto; Chester Bagg, baritone; Daniel Mason, trombonist; Edwin Sach, pianist; Evangeline Rendall, reader.

WDAF, Kansas City, Mo. (365.6), 4-4:45 p. m., services, Linwood Boulevard Methodist Episcopal church, Dr. William L. Stidger, pastor.

WDOD, Chattanooga, Tenn. (256), 7:30-9 p. m., church services.

WENR, Chicago, Ill. (266), 2-4 p. m., classical program; Rauland lyric trio; Marie Tully, soprano; Frank Westphal; sacred selections; 9:30-11:30, popular program; soprano solos; pianist; banjo and saxophone duetists.

WFAA, Dallas, Tex. (475.9), 2:30-4 p. m., Sunday hour for farmers; 6:30-7:30, Radio Bible class, Dr. William Anderson, Gospel song; 7:30-8:30, services, Westminster Presbyterian church, Dr. T. O. Perrin, pastor; Daisy Polk, soloist, director; 8:30-9:30, Earle Jackson and singers, Gaston Avenue Baptist church; 9:30-11, Little symphony orchestra, Grace Methodist church South, Dr. E. Barcus, pastor; Earle Behrends, musical director.

WGES, Oak Park, Ill. (250), 5-7:40 p. m., Lydia Werner, soprano; John Stamford, tenor; John A. McFarlane, bass; Marge Van, organist; Moody Bible institute program; Doc Berendson and his Tiffin theater orchestra.

WGN, Chicago, Ill. (302.8), 12 noon, comics, Uncle Walt; 12:45, program, Chicago theater; 2:30-3:30, Lyon and Healy organ recital; 3:30-5, Chicago Musical college concert; 9-10, Drake concert ensemble, vocal artists.

WHAD, Milwaukee, Wis. (275), 3:15 p. m., Turnverein symphony orchestra.

WHB, Kansas City, Mo. (365.6), 8 p. m., Christian Science services; 11:15, organ concert.

WHO, Des Moines, Iowa (230), 1 a. m., church services; 7:30-8:30 p. m., Rose-Hughes orchestra.

WHT, Chicago, Ill. (399.8), 12 p. m., Sunday dinner sacred concert, vocal, instrumental and organ; 12:45 p. m., sunshine hour, special program for the shut-ins and the sick; 1:15, shepherd time for the kiddies; 1:30, aerial girls program; 1:45, Radio rangers, boys' program; 2, Radio capoteur; 2:05, missionary program; 2:15, fellowship program; 2:50, afternoon services, Chicago Gospel tabernacle; 5:30, vesper concert; 5:45, Young women's council; 6:30, concert, tabernacle band and choir, sermon, Paul Rader; 9:30, request program; 10:30, back home hour.

WIBO, Chicago, Ill. (226), 2-4 p. m., concert; Ted Fiorito, Victor Young, Dan Russo; 6-8, Walter Preston, sacred songs; Fred Nobel, cornetist; Earl Raymond Bigelow, R. G. Ball, Raymond Barker, Helen Snyder; 10, program, Hamilton Club of Chicago.

WKAF, Milwaukee, Wis. (261), 4-6 p. m., Jean Hammond and her tango tinkers; Robert F. Hall, baritone; Ethel Brank, soprano.

WKRC, Cincinnati, Ohio (422.3), 6:45 p. m., songs and services, Walnut Hills Christian church; 10, classical program.

WLIB, Chicago, Ill. (302.8), 4-5 p. m., Chicago Philharmonic orchestra; 5:30-6:30, Fred Hamm and his Liberty orchestra; 8:15-9:15, Atwater Kent program, WEAF.

WLS, Chicago, Ill. (344.6), 6 p. m., Little Brown church.

WLV, Cincinnati, Ohio (422.3), 9:30 a. m., school, editorial staff of Sunday school publications, Methodist Book concern; 11, morning worship, Seventh Presbyterian church, Jesse Halsey, minister; 3 p. m., organ recital, Leo Thuis; 7:30, services, First Presbyterian church, Dr. Frederick McMillan, pastor; 8:30, concert, H. & S. Pogue company, Walter Esberger, director.

WMBB, Chicago, Ill. (250), 3-5 p. m., Trianon orchestra; Woodlawn theater orchestra; Tommy Hughes, Earle Smith, Scotty Welch, Madison Sisters; 7:40-9, Fifth Church of Christ Scientist; 9-11, Trianon orchestra; Woodlawn theater orchestra; Scotty Welch, Madison Sisters, Billie Allen Hoff, Walter Duffly.

WOAI, San Antonio, Tex. (395.5), 11 a. m., services, First Presbyterian church, Rev. P. D. Hill, pastor; 7:45 p. m., services, Central Christian church, Rev. Hugh McLellan, pastor.

WOAW, Omaha, Neb. (526), 9 a. m., chapel services, Rev. R. R. Brown; 2:30 p. m., matinee program; 6, Bible study period, Mrs. Carl R. Gray; 9, chapel services, St. John's English Lutheran church.

WOC, Davenport, Iowa (483.6), 1-2 p. m., orchestra concert; Palmer Little symphony, Erwin Swindell, conductor; Paul J. Vipperman, tenor; 6:30-7, services, Calvary Baptist church, "The Challenge of the Christ," Rev. T. G. Codd; 9:45-11:45, musical program; Palmer Little symphony; Erwin Swindell, conductor; soloists.

WOK, Chicago, Ill. (217.3), 1-2 p. m., Bernice Cummins Town club orchestra; Husk O'Hare's Coconut Grove orchestra; Harriet Lee, contra; Herman Sinaiko, violinist; George Allen, tenor; Bob Mokreis, pianist; 6-1:30 a. m., Husk O'Hare's Coconut Grove orchestra; Bernice Cummins Town club orchestra; Capitol theater complete musical program; WOK mixed quartet; Herman Sinaiko, violinist; Harriet Lee, contra; George Allen, tenor; Bob Mokreis, pianist; Bill Hay, bass.

WOK, Kansas City, Mo. (278), 11 a. m.-12:30 p. m., services; 7-7:45, services.

WORD, Batavia, Ill. (275), 10 a. m., hymns and sacred songs, solos, duets; 10:15, Bible lecture, W. E. Page; 7 p. m., Webster hotel instrumental trio; 7:10, hymns and sacred songs, I. B. S. A. choral singers; 7:20, address, L. M. Smith; 9, hymns and sacred songs, I. B. S. A. choral singers; 9:10, Esther Arneson, pianist; 9:20, Bible lecture, Oscar A. Olson.

WOS, Jefferson City, Mo. (440.9), 11 a. m., services, First Baptist church, Rev. Paul Weber, pastor.

WQJ, Chicago, Ill. (447.5), 9:30-11:30 a. m., People's church, Dr. Preston Bradley, minister; 3-4 p. m., Sunday afternoon musical concert, Marvin Hinshaw, director; 8-10, Ralph Williams and his Rainbo Gardens orchestra; Frederick Mueller, German tenor; Kathryn Diepenbrock, pianist; stringed trio, Louis Perlman, Oscar LaPedus, John Zwick; Fontella trio; Grace Wallace, soprano; Voris Worthley, tenor.

WSAI, Cincinnati, Ohio (325.9), 2:45-4:30 p. m., address, Dr. S. Parkes Cadman, Gloria trumpeters, George Betts, chimer, WEAF; 7:45, chime concert, Robert Badgley; 8, sermon, Bible service; 8:15-9:15, Atwater Kent hour, WEAF; Rosa Low, soprano; Benjamin Gigli, tenor; 9:15, Union Central Life Insurance company orchestra, Sigmund Culp, director.

WSM, Nashville, Tenn. (282.8), 10:30 a. m., First Presbyterian church, sermon, Dr. James I. Vance.

WSUL, Iowa City, Iowa (483.6), 9:15 p. m., familiar hymns, Esther Dyke.

Mountain Time Stations

CFAC, Calgary, Can. (435.8), 7 p. m., First church of Christ, Scientist.

KFXF, Colorado Springs, Colo. (250), 7:30-9 p. m., First Methodist church, services.

KOA, Denver, Colo. (322.4), 11 a. m., services, Montview Boulevard Presbyterian church; 3 p. m., afternoon music, Montview Boulevard Presbyterian church; 7:45, "Messiah," Montview Boulevard Presbyterian church.

Pacific Time Stations

KFON, Long Beach, Calif. (232.4), 6-6:30 p. m., organ recital, Brayton's theater; 8-9, services, First Church of Christ Scientist.

KFWB, Hollywood, Calif. (252), 9-11 p. m., late news, Warner Brothers holiday movie frolic with George Cronk's serenaders, California Blue Boys and others.

KGO, Oakland, Calif. (361), 11 a. m., Trinity Episcopal church; Rev. Charles P. Deems, rector; 3:30 p. m., KGO Little Symphony orchestra; William Edwin Chamberlain, baritone.

KGW, Portland, Ore. (481.5), 10:55 a. m., St. Stephens Pro Cathedral; 7:25-9, First Church of Christ Scientist; 9-10, Chevrolet Motor company.

KHJ, Los Angeles, Calif. (405.2), 6:30-7 p. m., Leighton's Arcade cafeteria orchestra, Jack Cronshaw, leader; 7-7:30, First Methodist Episcopal church organ; 8-10, second night of chamber music, Los Angeles Soap company.

KNX, Hollywood, Calif. (336.9), 2-4 p. m., City Park board outdoor musical program; 7-8, First Presbyterian church of Hollywood; 8-9, Ambassador hotel concert orchestra, Josef Rosenfeld, leader; 9-10:30, Sunday night classical hour.

KPO, San Francisco, Calif. (428.3), 9:45-10:45 a. m., undenominational and non-sectarian church services; "The Spirit of Christmas," Dr. C. E. Tingley; 5-6 p. m., organ recital, Marshall W. Giselman; 8-6:30, Waldemar Lind and the States restaurant orchestra; 6:35-7:30, Palace hotel concert orchestra; Cyrus Trobbe,



Frances W. Norris, soprano, left, wiling with the Messiah choir Sunday at KLDS, Independence, Mo. The pretty lady to the right is a WTAM entertainer, Ruth L. Kinney. She sometimes appears with the Coo Coo club of WTAM.



director; 8-8:35, Palace hotel concert orchestra; 8:35-10, Rudy Seiger's Fairmont hotel orchestra.

KPSN, Pasadena, Calif. (315.6), 8:45-9:45 p. m., Maryland artists' ensemble, Henri J. Van Praag, director.

KTAB, Oakland, Calif. (240), 9:45-10:45 a. m., Bible lecture, Prof. E. G. Linsley; 11-12:30 p. m., church services; 7:45-9, services; 9:30-11, concert.

Monday, December 28

Headliners Today

Eastern	Central	Mountain	Pacific
8 p. m.	7 p. m.	6 p. m.	5 p. m.
WMCA (340.6)	Knickerbocker family circle.		
9	8	7	6
KDKA (309.1)	Spear's Happy Home hour.		
KPRC (296.9)	Senor Adolpho Jimenez, Spanish tenor.		
WHAZ (379.5)	Little theater night, two plays.		
WTAG (268)	Robin Hood hour of music.		
10	9	8	7
KSD (545.1)	Double piano recital.		
KTHS (374.8)	Show hour.		
WOAW (526)	De luxe program.		
11	10	9	8
WEAF (491.5)	Grand opera, "Ernani."		
WLIT (394.5)	Vaudeville features.		
WSAI (325.9)	Community symphony, Christmas program.		
11:30	10:30	9:30	8:30
KOA (322.4)	Comedy skit, the Three Ralphs.		
1 a. m.	12 m.	11	10
KOIL (278)	Mona Motor Oil homecoming.		

Monday, silent night for: CHIC, CNRA, CNRW, CNRE, CNRM, CNRO, CNRR, CNRT, CNRV, CNRW, KFDN, KFEG, KFMO, KFMY, KFVA, KHJ, KLDS, KYW, PWX, WBBM, WCAD, WCBF, WEAQ, WEAH, WEBJ, WEBW, WENR, WGBS, WGES, WGN, WHAS,

Eastern Time Stations

CKAC, Montreal, Can. (411), 2:45 p. m., Christmas program, Capitol theater hour.

CKNC, Toronto, Can. (356.9), 10-12 p. m., Toronto Conservatory instrumental trio; Frank Blachford, violinist; Leo Smith, cellist; Alberto Guerrero; Lawrence DeFore, tenor; Madeline Bell, soprano.

KDKA, Pittsburgh, Pa. (393.1), 7:15-8 a. m., morning exercises, O. Shannon; 5:45 p. m., Lady That Travels Afar; 6:30, dinner concert; 9, Spear's Happy Home hour.

WAHG, Richmond Hill, N. Y. (315.6), 12-12:30 p. m., Nickels' trio; 7:30-8, Riako club orchestra; 8-8:15, Martha Brauninger, soprano; 8:15-8:45, Synchronophase trio; 8:45-9, Horace J. Taylor, dramatic recitations; 9-9:15, Richard Delunzio, violinist; 9:15-9:30, William Edelson, bass; 9:30-9:55, Synchronophase trio; 10-10:15, William Edelson, bass; 10:15-11, Joe Zimmerman's orchestra; 12-1 a. m., Brown's Trapezoidians, Ukulele Bob MacDonald.

WBAL, Baltimore, Md. (375), 6:45-7:45 p. m., WBAL dinner orchestra, Robert P. Iula, conductor; 8-9, musical program; Marie Buddy, soprano; Jacob Dasche, violinist; Walter Lintheum, baritone; 9-9:10, Swebson Earle, Maryland conservation commissioner; 9:10-10, musicale; Sol Sax, pianist; Hazel Fox, contralto; Antonio Lanasa, tenor.

WBZ, Springfield, Mass. (333.1), 6:30 p. m., Little Symphony orchestra, KDKA; 7:30, Capitol theater orchestra; 8, Copley Plaza orchestra, W. Edward Boyle, director; 8:30, organ recital, Rene Dagenais; 9, Aleppo drum corps or Shriners' band; 9:30, Springfield Conservatory of Music program; 10:05, Leo Reisman's Hotel Brunswick orchestra.

WCAP, Washington, D. C. (468.5), 6:45-7:45 a. m., Tower health exercises, WEAF; 6-11 p. m., Washington Post hour; Hohner harmonica hour, WEAF; A. and P. Gypsies, grand opera, WEAF.

WCAU, Philadelphia, Pa. (277.6), 8 p. m., "Tuning Your Receiver," Wilson N. Durham; 8:10, Florence Reese, soprano; Virginia Kline, pianist; 8:45, Barry O'Moore, American Radio trio; 9:10, Royal P. MacLellan, tenor; 9:30, Delaware serenaders; 10, Eddie Mack and Charles Borrelli, popular songs; 10:30, Parodians dance orchestra.

WCX, Detroit, Mich. (517), 6 p. m., dinner concert, Book-Cadillac hotel; 8, studio program.

WEAF, New York, N. Y. (491.5), 6:45-7:20 a. m., Tower health exercises, also through WEEL, WCAP; 11-11:10 a. m., Gladys M. Hawkins, pianist; 11:10-11:25, "Garden Talk," Leonard Barron, editor of Garden magazine; 11:25-11:35, Gladys Hawkins, pianist; 11:35-11:50, "Winter Sports," Thomas E. Rivers; 11:50-12, Gladys Hawkins, pianist; 4-4:30 p. m., joint recital, Bessie Booth Dodge, soprano; Nana Frances Holmes, reader; Mollie Bennett, violinist; 4:30-4:45, Lawrence Siebotom, boy alto, accompanied by Winifred T. Barr; 4:45-5, "A Spanish Bull Fight," Robert McBridge; 6-7, dinner music, Hotel Waldorf-Astoria; 7-7:15 p. m., Marjorie Lambkin, entertainer; 7:15-7:30, Hans Barth, pianist; 7:30-8, "The Lullaby Lady"; 8-8:30, "Hohner Harmony Hour," also through WEEL, WJAR, WOO, WVVJ, WCAP, WGR; 8:30-8:45, "Pop Concert," also through WOO; 8:45-9, "Tower Health Talk," also through WEEL, WCAP; 9-10, music by the A. and P. Gypsies, also through WEEL, WCAP, WVVJ, WJAR, WOO, WSAI; 10-11, "Ernani" by WEAF

Grand Opera company, orchestral accompaniment direction of Cesare Sodero, also through WOO, WJAR, WCAP, WTAG, WCAE; 11-12, Ben Bernie and his orchestra.

WEEL, Boston, Mass. (348.6), 2 p. m., Happy Hawkins and his orchestra; 6:45, Big Brother club; 7:30, Perkins Beale ensemble; 8, Hohner Harmony hour; 8:30, musicale; 8:45, Tower health talk, WEAF; 9, A. and P. Gypsies, WEAF; 10, Scotty Holmes and his orchestra; Imperial Marimba band.

WFI, Philadelphia, Pa. (394.5), 10:15 a. m., reports; 10:30, solos; 10:40, home service talk; 1 p. m., tea room ensemble; 3:30, Bronson string quartet; 6:30, Bellevue Stratford concert orchestra; 7, Bellevue Stratford dance orchestra.

WGBS, New York, N. Y. (315.6), 10-10:10 a. m., timely talks with Terese; 10:10-10:20, Jack Cohen, jazz pianist; 10:20-10:30, stagecraft, Dorothy Herzog; 10:30-10:40, Jack Cohen; 10:40-10:50, fashion talk, Lillian Regan; 10:50-11, Jack Cohen, pianist; 1:30-1:35 p. m., Scripture reading; 1:35-2, Florence Loftus, soprano; 2-2:15, Clare Schaeffer, bass; 3-3:10, Mrs. Clarence M. Smith, National Women's party program; 3:10-3:20, George Madden, tenor; 3:20-3:30, George Madden, tenor; 3:30-3:40, League of Women Voters program; 6:30-7, Uncle Geebee; 7-8, Premier club orchestra.

WGCP, New York, N. Y. (252), 12:15 p. m., Mirror race results and latest news items half hourly throughout the day; 3-3:15, Eva Rothenberg, pianist; 3:30-3:45, Pendleton and Moore, entertainers; 4-4:15, Jack Davis, songs; 4:15-4:30, Shirley Herman, songs; 4:30-5, Uncle Robert and his Pals; 5-5:15, Sherman and Pollack; 5:15-5:30, Judith Roth, soprano; 6:15-6:30, Littmann's orchestra; 6:30-6:45, Daddy Dingle and his Jingle Machine; 8:30-8:45, Perry Bradford, entertainer; 8:45-9:10, "Inspirational Talk to Boys," Philip Wolf; 9:10-9:40, Loomis orchestra; 9:40-10, Bob Ward and three Little Wards; 10-11, Strickland's orchestra; 11-11:30, Connie's orchestra; 11:30-12, Murphy's entertainers.

WGHF, Clearwater, Fla. (266), 6-7 p. m., Fenway hotel trio; 7:30, fashion revue; 8, Seaside hotel trio.

WGR, Buffalo, N. Y. (319), 2:30 p. m., WGR's afternoon program; 6:30, Clef Dwellers orchestra; 9-11, popular musical program; 11-1 a. m., Vincent Lopez Hotel Statler dance orchestra, Harold Gieser, director.

WGY, Schenectady, N. Y. (379.5), 2 p. m., Asia restaurant orchestra; 2:30, music; cooking lesson, Jessie B. Lane; "How to Select Furs," Ruth Scott; 6:30, dinner program, Reed Hamaker's Hotel Van Curler orchestra; 7, WGY agricultural program, addresses; 7:45, program, Turner Macmerchor, Frank H. Kinum, conductor; literary presentation series, William L. Widdemer.

WHAR, Atlantic City, N. J. (275), 2 p. m., Seaside hotel trio; 7:30, fashion revue; 8, Seaside hotel trio.

WHAZ, Troy, N. Y. (379.5), 9 p. m., "Mr. Bob" and one-act comedy, presented by Masque of Troy; 9:30, "The Literature of 1926," Prof. H. H. Nugent; 10:30, King Jazz and his orchestra.

WHN, New York, N. Y. (361.2), 6-6:30 p. m., Littmann's dinner music; 6:30-6:45, Daddy Dingle and his Jingle Machine; 6:45-7, Littmann's dinner music; 7-7:30, Marlboro State trio; 7:30-8, Joe Ward's Swanee entertainers; 8-8:05, "Storage Batteries," E. B. Shontz; 8:05-8:30, Roseland dance orchestra; 10-10:30, Shanley's orchestra; 10:30-11, Fritivity orchestra; 11-11:30, Cotton club orchestra; 11:30-12, Silver Slipper orchestra; 12-12:30 a. m., Ted Lewis and his orchestra.

WIP, Philadelphia, Pa. (508.2), 6:45 a. m., setting-up

WAHG WILL WATCH OLD YEAR RETIRE

Wednesday, December 30

WEAF, New York, N. Y. (491.5), 6:45-7:20 a. m., Tower health exercises; 10:45-12 noon, Betty Crocker Gold Medal Flour home service talk; musical program; lecture, "Home Management," Columbia university; 4-5 p. m., Alma O'Haire, soprano; Ray Nichols recording orchestra; "Great Moments from Shakespeare," Loyal R. Blaine; 6-7, dinner music, Hotel Waldorf-Astoria; 7-10, concert, U. S. Army band from Washington, D. C.; Huyler's Bon Bon Buddies, Pooley concert, Ipana troubadours; 10-11, musical program, Roxy and his gang; 11-12, Ben Bernie and his orchestra from Hotel Roosevelt.

WEAO, Columbus, Ohio (293.9), 8 p. m., "Elementary Radio," R. C. Higgy; music; 8:15, "Illumination and Vision," Prof. Howard D. Minchin; 9, May Furniture company girl's orchestra.

WEI, New York, N. Y. (272.6), 8-8:45 p. m., Balconades ballroom orchestra; 8:45-9, Gordon Beresford, presenting "On With the Dance"; 9-9:30, Busoni's Neapolitan troubadours; 9:30-9:45, Alfred Dulin, concert pianist; 9:45-10, Kathryn Connolly, soprano.

WEEL, Boston, Mass. (348.6), 6:45 a. m., Tower health exercises; 7:45, morning watch, Y. M. C. A.; 1 p. m., assembly luncheon, Chamber of Commerce; 3, Johnnie Bowles and his orchestra; 5, Chet Frost and his original Bostonians; 6:45, Big Brother club; 7:30, Perkins Beale ensemble; 8, Huyler's Bon Bon Buddies; 8:30, Earl Nelson and his uke; 9, Ipana troubadours; 10, musical program, Roxy and his gang.

WFI, Philadelphia, Pa. (394.5), 10:15 a. m., reports; 10:30, solos; 10:40, home service talks; 1 p. m., Rotary club dinner, Bellevue-Stratford; 3, saxophone solos, Bessie M. Hackenberger; 6:30, Bellevue-Stratford concert orchestra; 7, Bellevue-Stratford dance orchestra.

WGBS, New York, N. Y. (315.6), 10-10:10 a. m., timely talks with Terese; 10:10-10:20, Bernard Kakin, organist; 10:20-10:30, beauty talk, Mary Polly; 10:30-10:40, Miriam Miller, pianist; 10:40, Olive Koch, "House Furnishings"; 1:20-1:35 p. m., Scripture reading; 1:35-2, Robert Soffer, jazz pianist; 2-2:30, Mac and Lennie, popular duo; 3-4, special children's Christmas program, auspices New York Graphic; 6-6:30, Uncle Geebee; 6:30-7:30, Jersey Collegians orchestra.

WGCP, New York, N. Y. (252), 12:30 p. m., Mirror race results and latest news items half hourly throughout the day; 3-3:15, Henry Rogers, pianist; 3:15-3:30, Bobby Grey, songs; 3:30-3:45, Monis Zimmerman, violinist; 4-4:15, dental talk, Dr. J. O. Schwarz; 4:15-4:30, Jeanne Adair, composer; 4:45-5, Charlotte Trystmann, pianist; 5-5:15, Bert Dixon, baritone; 7-7:15, studio recital; 7:15-7:30, Kennedy harmony group; 8-8:15, Hoek and Jerome, songs; 8:15-8:30, Charol de Thome, concert pianist.

WGHB, Clearwater, Fla. (266), 6-7 p. m., Fenway hotel orchestra; 8:30-9:30, Caroline Lee, the Virginia girl, and Bill Ewin.

WGR, Buffalo, N. Y. (319), 2:30 p. m., WGR's afternoon program; 6:30, Gospel Melodists; 8, Adam, Meldrum and Anderson program; 9, jointly with WEA, Ipana Troubadours; 11-1, Vincent Lopez Hotel Statler dance orchestra, Harold Gieser, director.

WGY, Schenectady, N. Y. (379.5), 6:30 p. m., children's program; 6:45, dinner program, Eastman theater orchestra; 7:30, Book of Knowledge program; 8:05, musical program, Rochester, WHAM.

WHN, New York, N. Y. (361.2), 6-6:30 p. m., Littmann's dinner music; 6:30-6:45, Daddy Dingle and his jingle machine; 6:45-7, Littmann's dinner music; 7-7:30, Ted Lewis and his orchestra; 7:30-8, the cheerful philosopher, Burr McIntosh; 8-9, Calvary Baptist church services; 10-10:30, Roseland dance orchestra; 10:30-11, Frivolity orchestra; 11-11:30, Silver Slipper orchestra; 11:30-12, Lew Brown and Sidney Claire, songs; 12-12:30 a. m., Cotton club orchestra; 12:30-1, Harry Richmond and his entertainers.

WIP, Philadelphia, Pa. (308.2), 6:45 a. m., setting-up exercises; 7, setting-up exercises; 10:30, reducing exercises, Dr. Francis D'Eliscu; 1 p. m., Gimbel tea room orchestra; 3, artist recital; 6:05, Benjamin Franklin concert orchestra; 7, Uncle Wip's bedtime stories.

WJR, Pontiac, Mich. (517), 7 p. m., Jean Goldkette's Petite symphony orchestra, soloists; 9, Jean Goldkette's serenaders, soloists; 11:30, Jewett Jesters, Merry Old Chit.

WKAQ, San Juan, P. R. (340.7), 7-9 p. m., musical selections, Municipal band; Prof. Manolo Tizol, conductor.

WLIT, Philadelphia, Pa. (394.5), 12:02 p. m., daily almanac, Arcadia cafe concert orchestra, Stanley theater organ recital; 2, Arcadia cafe concert orchestra; 7:30, Dream Daddy's bedtime stories; 8, Pennsylvania male quartet; 9, Philadelphia Rapid Transit company band concert; 10, Arcadia cafe dance orchestra.

WMCA, New York, N. Y. (340.6), 6-6:30 p. m., Oleott Vail and his Hotel McAlpin string ensemble; 6:30-7:30, Ernie Golden and his Hotel McAlpin orchestra; 7:30-8, Spanish lesson, Professor Cortina; 8-8:15, standard statistics; 8:15-9:30, Northminster church services; 9:30-10, Audubon theater program; 10-10:20, readings, Heda Goldmeyer; 10:20-11, Robert Yopp, Hawaiian guitar ensemble; 11-11:30, Hofbrau Haus entertainers; 11:30-12, Jack Smith, whispering baritone.

WNYC, New York, N. Y. (526), 6:20-6:30 p. m., piano selections; 6:30-7, Spanish lessons; 7:35-8:30, dance program; 8:30-9, Gedney's banjo orchestra; 9-9:15, Chris Meehan, tenor; 9:15-9:30, song recital; 9:45-10:10, piano recital; 10:10-10:30, lecture.

WOO, Philadelphia, Pa. (308.2), 11 a. m., organ recital; 12 noon, Golden's Crystal tea room orchestra; 4:45 p. m., organ recital; 7:30, Hotel Sylvania orchestra; 8, U. S. Army band; 8:30, Pooley period; 9, American male quartet; Fred J. Brown, tenor; Carl A. Lavless, tenor; Robert E. Kerwin, baritone; Felix J. Addis, bass; 10, Fox theater program; 10:30, Hotel Sylvania dance orchestra.

WOR, Newark, N. J. (405.2), 6:15-6:30 p. m., "Words Often Mispronounced"; 6:30-6:45, sport talk, Bill Wathey; 6:45-7:30, Jacques Jacobs' Hotel Shelton ensemble; 8-8:15, topics of the day, Spencer Armstrong; 9-9:15, Sam Siegel, mandolin virtuoso; 9:15-9:30, Dr. Vitzel, lecturer; 9:30-9:45, Sam Siegel, mandolin virtuoso; 11:30-12, Vincent Lopez Pennsylvania orchestra.

WRC, Washington, D. C. (468.3), 10 a. m., women's hour, WJZ; 12 m., Gertrude Smallwood, organist; 1 p. m., Lee House trio; 5, Meyer Davis' New Willard hotel trio; 6, "Things Talked About," Nina Reed.

WTAG, Worcester, Mass. (268), 10:30 a. m., musical selections; 10:45, talk to housewives, Lydia Flanders; 12:05-2 p. m., luncheon music, Will Hardt, director; 4:45, talk; 7:15, Twinkle Twinkle story teller; 7:30, "How to Choose a Wife," Harold Whitehead; 7:40, Spanish lesson, Mrs. John De La Parra; 8-10, concert program; 10-11, Roxy and his Gang, WEA.

WTAM, Cleveland, Ohio (389.4), 12:15-1:15 p. m., lunch hour; 6-7, dinner dance music, Guy Lombardo and his Royal Canadians; 8-10, concert program; 10-11, Hollenden hour, Carl Rupp and his Hotel Hollenden orchestra; 11-1, dance music, Guy Lombardo and his Royal Canadians.

WTIC, Hartford, Conn. (475.9), 6:30 p. m., Hotel Bond trio, vocalists; 10, Emil Heimberger's Hotel Bond orchestra.

WVJ, Detroit, Mich. (352.7), 7:30-8 a. m., setting-up exercises, R. J. Horton; 9:30, "Tonight's Dinner," and a special talk by the woman's editor; 12:05 p. m., Jules Klein's Hotel Statler orchestra; 3, Detroit News orchestra; 6, dinner concert; 8, News orchestra and soloists; 9, dance program; 10, Roxy and his gang.

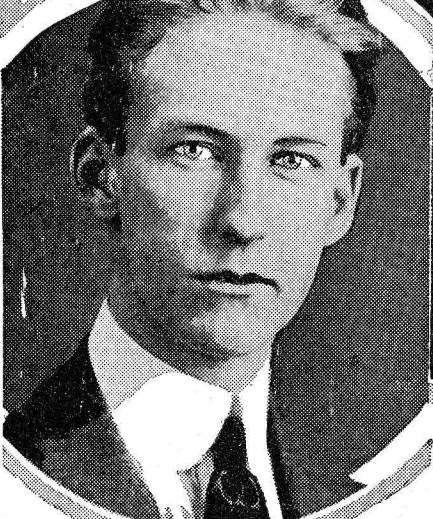

The New Year will be welcomed cordially at WAHG, Richmond Hill, by Chandler Goldthwaite, organist, and Doris Sheldon, contralto, above. Another member of the WAHG family is Martha Branning, soprano, right, who entertains every Monday night at this station.

"Dairy Day—Do Cows Need Minerals?" 5:30, dinner concert, KDKA; 9, program, University School of Music.

KFMX, Northfield, Minn. (337), 9-10 p. m., musical program.

KFNF, Shenandoah, Iowa (266), 7 p. m., glad gang, Syracuse, Lester, Reuter, director.

KFUO, St. Louis, Mo. (545.1), 9:15 p. m., "Abide with Us," Rev. F. Herzberger; songs and music.

KFVE, University City, Mo. (240), 9:15 p. m., amusement review, Romaine Fielding; Paul and Jack Snyder, entertainers de luxe; Orchestra Romaine.

KMA, Shenandoah, Iowa (252), 11:30 a. m., rural program, garden talk, Earl E. May; 5:30 p. m., travelog, G. H. Van Houten; 6-7, domestic science talk, Leon Teget; 9-11, music, Morton Gregson Packing company; songs and clog dance, Bobbi and Babe Riddle.

KOIL, Council Bluffs, Iowa (278), 6:15-6:30 p. m., talk fest; 6:30-7, Randall's Royal Fontenelle orchestra; 7-7:15, "What's Doing in Town Tonight?"

KPRC, Houston, Texas (296.9), 12 m., Lion's club luncheon program; 5:30 p. m., Uncle Judd's Kiddies hour; 7:30, Betty Martin's End O'Main dance orchestra; Mark A. Westcott, vocalist.

KSD, St. Louis, Mo. (545.1), 7 p. m., Fur hour; 8, WEA.

KSO, Clarinda, Iowa (241.8), 7-9 p. m., artists' program.

KTHS, Hot Springs National Park, Ark. (374.8), 12:30-1 p. m., orchestra; 9-10, stringed quartet, New Arlington hotel, numbers, Grand ensemble; 10-11, frolic, Southern Majestic hotel orchestra.

KYW, Chicago, Ill. (535.4), 6:30-7 a. m., morning exercises, Paul A. Leonhardt; 7:30, family worship; 11:35, table talk, Anna Peterson; 12:05 p. m., concert, Commonwealth Edison company; 1, luncheon concert, Congress hotel; 6, dinner music, KDKA; 7:05, Uncle Bob's bedtime story; 7:30-8, musical program, Congress hotel; Sherwood school of music; 10-12:30 a. m., midnight revue; Paul Ash and his orchestra; Coon-Sanders Original Nighthawks; Henri Keates, organist; 1, Insomnia club.

WAMD, Minneapolis, Minn. (243.8), 12 m., musical program; Margaret King, soprano; Hazel Stageberg, pianist; Clarence Nutt, tenor; Kenneth Spears, violinist; C. Wesley Anderson, pianist; 7:05, Garrick theater symphony orchestra, Fred Heiseke, director; 7:09, harmony twins, Fred Roble and Bob Melcher; Elizabeth Schmidt, Martha Cooper, duettists; saxophone solos; Bob Barker, tenor; 11, Skyrocket frolic; George Osborn's Hotel Radisson Skyrockets.

WBBM, Chicago, Ill. (226), 4-6 p. m., Harry Sosnik, Sandy Meek; Valentino Inn orchestra; Edna Wheeler

Floyd Falch, Art Bilquist, Archie Rawls; 12-2 a. m., All American Pioneers; Frank Westphal; Marie Tully, Art Bilquist.

WFAA, Dallas, Tex. (475.9), 12:30-1 p. m., Sears-Roebuck Agricultural Foundation program.

WGES, Oak Park, Ill. (250), 5-7 p. m., studio artists; 8-9, Gus Edwards and his jazz band, artists; 11-1 a. m., orchestra, popular entertainers.

WGN, Chicago, Ill. (302.8), 7 a. m., setting-up exercises; 11-11:30, fashion fancies; 11:30-12 noon, Sally Joy Brown; 12, household hints; 12:40-2:30 p. m., Drake concert ensemble, Blackstone string quintet; 2:30-3, Lyon and Healy artists' series; 4-4:15, sea time music, Marshall Field tea room orchestra; 4:30-5, Edward Benedict, organist; 5:30-5:57, children's program; 6:30-7, Drake concert ensemble, Blackstone string quintet; 8-9, hour of music; 10-11, Jack Chapman's orchestra; Blackstone hotel dance orchestra.

WHAD, Milwaukee, Wis. (275), 11 a. m., pianologue, Andy Hertel; the Housewife; 4 p. m., "With the Humorists," John R. Wolf; Mrs. Marie Weiss, pianist; Linda Herne, saxophone; 6:15-7, Arthur Richter organist; 10:30-11:30, popular dance hits, Dexter's Wisconsin and Elger's Creole roof orchestras; 11:30-12:30 a. m., Edmund Fitch, organist.

WHB, Kansas City, Mo. (365.6), 7-8 p. m., Strong trio, vocalists.

WHO, Des Moines, Iowa (526), 6:30-7:30 p. m., Reese-Hughes orchestra; 7:30-9, artists, Capitol theater; Harvey Waugh, violinist; Smith Sisters; Kate Miller, whistler; Maude Hughes, accompanist; Wendell Reed, Herbert Kale, harmony singers; 9-11:30, dance, Cottol-Bon ballroom.

WHT, Chicago, Ill. (399.8), 10 a. m., Jean Sargent's program, woman's club, Borden health talk; Elke Good Luck Girl, studio music; 10:45, Betty Crocker home service; 11, special studio features; 12 p. m., Al Carney's complimentary organ hour; 1-2, special studio program, Grayling string trio; 6-7:30, classical program, dinner organ recital, Pauline Sachs, Phyllis Burton, violinist; Pauline Peebles, pianist; Jean Carlson, soprano; Hugh Aspinwall, tenor; Grayling's string trio; 7:45-9:15 (238), musical features; 9:30 (399.8), Borden request organ recital, Hickey and Johnson, harmony; Carl Strudel, baritone; Leota Laabe, soprano; Irene Beasley, the Girl from Dixie; Northland trio; Vic Fredericks, baritone; Charles R. Hall, tenor; Badger Four male quartet; Ray Lawson, tenor; 12, Pat Barnes and Al Carney.

WIBO, Chicago, Ill. (226), 2-4 p. m., shut-ins program; Jack Sprat and the Carl Sulzer orchestra; Ted Florio, pianist; Victor Young, Dan Russo, violinists; Vernon Hayes, saxophonist; "Home Economics," Grace Viall Gray; 6-8, Walter Preston, popular American ballads; Dorothy Rae, soprano; Earl Raymond Bigelow, pianist; Charlotte Edwards, contralto; Joe North, baritone; Shepard Levine, tenor; 10, Erwin Cornelius, ukulele; male quartet; William Molnair, tenor; Hickey and Johnson, Alma Adair, soprano; Dorothy Aubrey, contralto; Fred Jacobsen; Dorothy Davie Dillow.

WKAF, Milwaukee, Wis. (261), 10-11 p. m., Ted Osmondson, baritone; Viola Sontag, pianist.

WKRC, Cincinnati, Ohio (422.3), 8 p. m., book review; 8:15, Marion McKay and his orchestra; 8:30, popular songs; 9, J. Henry Koenig Little Symphony orchestra; Robert H. Visconti, Blue Grass tenor.

WLIB, Chicago, Ill. (302.8), 7-8 p. m., dinner concert; 9-10, program, WEA; 11-12, Jack Chapman's orchestra; Blackstone hotel dance orchestra.

WLS, Chicago, Ill. (344.6), 12-1 p. m., R. F. D. farmer program; 6:30, Ralph Emerson, organist; 7, Ford and Glenn lullaby time; 7:15, WLS trio; 7:45, WLS theater; 8:15, Metropolitan choir; 9:15, Ernst Moeller, pianist; 9:30, St. Ita's church boys choir; 10, Thavin brass sextet; 10:40, St. Ita's choir quartet; 11-2, WLS circus.

WLW, Cincinnati, O. (422.3), 7:30 a. m., exercises, Wm. Stradtman of the Y. M. C. A.; 7:45, morning devotions, auspices of Parkway Y. M. C. A.; 12 m., Frank Downing, pianist; 3:30 p. m., Crosley cooking school, conducted by Mrs. Ralph H. Auch; 4, shut-in program, William Dunning; 7, dinner hour, Hotel Gibson, Robert Visconti, director; 7:30, talk, L. B. Palmer, president Ohio Farm Bureau federation; 7:40, Hotel Gibson concert; 10, piano memories, Mary Louise Woseczek; 10:20, "New Year's Eve" reading, Charles Meade; 10:30, Crosley male quartet; 10:45, dance music, Castle Farm; 11:15, Johanna Grosse, Crosby organ request lady; 11:30, pianologues, Carl Bramberger.

WMAQ, Chicago, Ill. (447.5), 12:45 p. m., Radio farm school; 1, luncheon program; 2, shut-in program; 4 recipes, E. O. Hiller; 4:30, Cosmopolitan school of music; 6, Chicago theater organ recital; 6:30, George Gene Faulkner, story lady; 8, lecture, Northwestern university; 8:30, musical program; 9, WMAQ players.

WMBB, Chicago, Ill. (250), 7-8 p. m., Trianon duo; M. Mathews, contralto; 9-11, Trianon orchestra; Woodlawn theater orchestra; Cecil and Esther Ward; Billie Allen Hoff; Scotty Welsh, Madison Sisters.

WOAI, San Antonio, Texas (394.5), 3 p. m., musical program; 8:30-9:30, army night, musical program.

WOAW, Omaha, Neb. (526), 12:45 p. m., Phyllis Griswold, organist; 5:30, Sandman's visit.

WOC, Davenport, Iowa (483.6), 12:15-12:25 p. m., farm school; "Dairy Day—Do Cows Need Minerals?"; 3-3:30, home management schedule, Aunt Jane; 5:45-6, chime concert; 6:30-6:50, Sandman's bedtime stories; 9-10, Erwin Swindell, organist; John Gerwe, tenor.

WOL, Ames, Iowa (270), 12:30 p. m., college chimes; 12:45, "Poultry Husbandry," Prof. H. A. Bittenbender.

WOK, Chicago, Ill. (217.3), 5-7 p. m., Capitol theater organ; Ed Kemp, tenor; Bob Mokrejs, pianist; Bryce Talbot, baritone; 10-1:30 a. m., Bernie Cummins' Town club orchestra; Capitol theater program; Ned Miller, tenor; Harriet Lee, contralto; Herman Sinalko, violinist; George Allen, tenor; Bob Mokrejs, pianist.

WORD, Bataavia, Ill. (275), 7 p. m., Webster hotel concert trio; 7:15, hymns and sacred songs, solos, duets; 7:25, Bible lecture, M. E. Woodley; 9, Webster concert trio; 9:10, I. B. S. A. choral singers; 9:20, "The First Ascending Passage," Calvin H. Swingle.

WOS, Jefferson City, Mo. (440.9), 8 p. m., address, E. E. Underwood; varied musicale, First Christian church, Rev. Haushalter, pastor.

WQI, Chicago, Ill. (447.5), 11-12 m., fish dinner menu, Frank Wendt; talk, Dr. Sadlers; 3-4 p. m., "Using Up Leftovers," Helen Harrington Downing; 7-8, Babu Williams and his Rainbow Gardens orchestra; 10-11, Ralph Williams and his Rainbow Sky-larks; Melodians; Clarence Theaders, tenor; J. Edwin Peterson, bass; Joey Stool, tenor; Eddie Vogel, baritone; George Thurn, kazoo soloist; Harry Kendall, guitarist; Anita Chellis, comedienne; Thelma Pfefferle, soprano; 1-2, Ginger hour.

WSAI, Cincinnati, Ohio (325.9), 7:45 p. m., art talk, John E. Weiss; 8-9, Ipana troubadours, WEA; 9-10, program; 10, talk, Dean Josephine Simrall; 10:15, studio program, Congress Playing Card string quartet.

WSB, Atlanta, Ga. (428.3), 10:45 p. m., Melody artists.

WSM, Nashville, Tenn. (282.8), 6:30 a. m., Francis Craig and his orchestra; 7, bedtime story interlude; 8, Scottish Rite chorus; 10, Mrs. Henry O. Fulton and associate artists of Columbia.

WSOE, Milwaukee, Wis. (246), 5:30 p. m., twilight hour musicale; 8, open air holiday program, 9, program, community singing, Samuel J. McKillop, director.

Mountain Time Stations

CFAC, Calgary, Can. (435.8), 4 p. m., Red Cross address; 8-9, studio program.

KFWA, Ogden, Utah (261), 4-5 p. m., organ recital, Paramount theater; 5-6, Ogden Radio Dealers program; 9-10:30, Paramount theater orchestra; 10:30-12, Olie Reeves and his orchestra.

KOA, Denver, Colo. (322.4), 12:15 p. m., Rialto theater musicale; 6:30, dinner concert, Brown Palace string orchestra; 7:30, Book of Knowledge; 8, "The Silver Fox," KOA players; KOA orchestra.

Pacific Time Stations

KFDJ, Corvallis, Ore. (282.5), 7:30 p. m., musical selections; 7:45, "Money Plans for the Home Income in 1926," Emma S. Weld; 8-8:15, "Which Shall It Be—Serge or Satin?" Alma Fritchhoff.

Wednesday, December 30

KFOA, Seattle, Wash. (454.3), 12:30-1:30 p. m., Rotary club luncheon; 4-5:15, Wm. F. Hoffman's orchestra; today's recipe; 6-6:45, Hoffman concert orchestra; 6:46-8:15, Hopper Kelly company studio; 8:30-10, Times organ recital, Elk's club.
KFON, Long Beach, Calif. (232.4), 4:30-5 p. m., amusement bulletin; 6-6:30, organ recital from Brayton's theater; 8-9, Press-Telegram program arranged by L. D. Frey.
KFWB, Hollywood, Calif. (252), 5-6 p. m., children's hour, Big Brother of KFVB; 7-7:30, Mutual Motors; 7:30-8, microphone brevities; 8-9, program, Check-Neal Coffee company, Maxwell House Coffee string quartet; 9-10, Hoot Owl Harbort program, Bill Hatch's Hoot Owl orchestra; 10-11, Warner Brothers frolic, direction Charlie Wellman; 11-12, Hollywood Roof ballroom orchestra.
KGO, Oakland, Calif. (361), 11:30-1 p. m., luncheon concert; Pacific States Electric company; 3-4, Eva Garcia, pianist; Grace Le Page, soprano; Antonio de Grassi, violinist; 4-5:30, concert orchestra, Hotel St. Francis; 5:30, Mr. Fix-It; 6-7, Norman Woodside's Metropolitan orchestra.
KWV, Portland, Ore. (481.5), 12:30-1:30 p. m., Rose City trio; 6-7, dinner concert; 8-9, Western Auto Supply company; 10-11, Sherman, Clay and company studio.
KHJ, Los Angeles, Calif. (405.2), 6-6:30 p. m., Leighton's Arcade cafeteria orchestra, Jack Cronshaw, leader; 6:30-7:30 p. m., history story, Prof. Hertzog; Daniel De Luce and Beatrice Wilson, saxophone duets; Dick Winslow, juvenile reporter; Mickey McBan and Vivian Marple, seven starlets; 8, Dr. Marc Baumgardt, scientific lecturer; 8:30-10, program, Broadway Department store; 10-11, Don Clark's Biltmore hotel dance orchestra.
KMTR, Hollywood, Calif. (238), 5-6 p. m., home hour, Mammy Simmons and pupils of Geraldine Kasal, Irene Bennett, Louise Trooper; 8-10, Turner orchestra, Loren Powell, director; Rondeau male quartet; 10-11, Starr Piano company studio.
KNX, Hollywood, Calif. (336.9), 5-5:30 p. m., Sunny JWS's talk to children; 5:30-6:15, Wurlitzer pipe organ studio; 6:15-7, travel talk, W. E. Alder; 6:30-7, Atwater Kent concert orchestra, Paul Feinstein, leader; 7-8, Ambassador hotel concert orchestra, Josef Rosenfeld, director; 8-9, program, Security Trust & Savings bank; Sarah Ellen Barnes' talk on the symphony orchestra; 9-10, popular program, W. W. Rainey organization; 10-11, dance music.
KOB, San Francisco, Calif. (428.3), 7, 7:30, 8 a. m., daily dozen exercises; 10, sewing talk, Betsy Ross; 1-2 p. m., Rudy Selge's Fairmont orchestra; 2-3:30, popular music, James Lono's Hawaiian orchestra; 3-3:30, fashion talk, Ninon; 5:15-6:15, children's hour stories, Big Brother; 6:40-7, Waldemar Lind and the States restaurant orchestra; 7-7:30, Rudy Selge's Fairmont hotel orchestra; 8-9, Atwater Kent artists, Ernest Ingold, Inc.; 9-10, Goodrich Silvertown Cord dance orchestra; 10-11, Waldemar Lind and the States restaurant orchestra.
KTAB, Oakland, Calif. (240), 9-9:30 a. m., prayer service, Rev. G. W. Phillips.
KTLA, Fullerton, Wash. (348.6), 7:30-9 p. m., Pauline Williams, pianist; "Pyrotol, a Safe Explosive," R. N. Miller; "The Proper Housing of Poultry," J. S. Carver.

AN EVENING AT HOME WITH THE LISTENER IN IN CENTRAL TIME

Table with columns: Call, Location, Met., Saturday, Sunday, Monday, Tuesday, Wednesday, Thursday, Friday. Lists radio stations and their schedules for the week.

Thursday, December 31

Headliners Today

Table with columns: Eastern 8 p. m., Central 8 p. m., Mountain 7 p. m., Pacific 6 p. m. Lists radio stations and their programs for the day.

Eastern Time Stations

KDKA, Pittsburgh, Pa. (309.1), 7-15, 8 a. m., morning exercises, O. Shannon; 5:45 p. m., Uncle Ed; 6:30, KDKA Little Symphony orchestra, Victor Saudek, conductor; 9, concert, KDKA Symphony, Victor Saudek; 10:10, Shrine band, orchestra, Syria Mosque; 11, Watch Night service; 12:15, dance program, Morrowfield hotel.
WAHG, Richmond Hill, N. Y. (315.6), 12-12:30 p. m., Nickels trio.
WBAL, Baltimore, Md. (375), 6:45-7:45 p. m., dinner program, WBAL orchestra, Robert P. Iula, conductor.
WBZ, Springfield, Mass. (333.1), 6:30 p. m., Little Symphony orchestra, KDKA; 7:30, Hotel Kimball dance orchestra, Bob Patterson, director; 8, concert; 8:30, Helms, soprano; Pauline Taylor, violinist; Marion Wynne, pianist; 9, Irish music program, Patrick Gaffney, Susanne Peters, pianist; 9:30, guitar and ukulele specialties, Ralph Hanna and Brenton Roberts; 10:05, organ recital; 11, Watch night service, South Congregational church, Rev. James Gordon Gilkey, pastor; music, Prof. Wilson P. Moore, organist; quartet; Grace R. Donovan, soprano; Nora Winton, contralto; William Spittal, tenor; Albert Edwards, bass; 11:50, New Year's revue, Capitol theater.
WCAD, Canton, N. Y. (263), 8 p. m., 12 midnight, dance program, Northern Dansoan orchestra.
WCAP, Washington, D. C. (468.5), 6:45-7:45 a. m., health exercises, WEAF; 7-11 p. m., Popular Science talk; chimes, Church of the Epiphany; dance program, Wardman Park hotel.
WCAU, Philadelphia, Pa. (277.6), 6:30 p. m., Billy Hayes and his Cathay Tea Garden dance orchestra; 7:30, N. Stenburgh orchestra; S. Mitchell Gondoliers; 8:15, Michael Fonticoli, tenor, Elizabeth Papetina, coloratura soprano; 8:45, Kandy Kids; 9, Barry O'Moore, Irish tenor; 9:30, Musical Chorus; 10, Sesqui hour; 11, Parodians dance orchestra and Club Cadix revue.
WCX, Detroit, Mich. (517), 6 p. m., dinner concert, Book-Cadillac hotel; 8, musical program.
WEAF, New York, N. Y. (491.5), 6:45-7:20 a. m., "Power Health Exercises" also through WCAP; WEEL; 11-12, Christmas carols, Men's and Women's Glee clubs of the Metropolitan Life Insurance company direct from Great Hall of Metropolitan Life building, address, Bishop William T. Manning; 12-12:20 p. m., Christmas carols, employees of the American Telephone and Telegraph company; 12:20, carol service, St. Paul's church; 4-5, The Tennesseeans dance orchestra; 6-7, dinner music, Hotel Waldorf-Astoria; 7-7:30, Mid-Week "Hymn Sing" under auspices of Greater New York Federation of Churches; 7:30-8, "Happiness Candy Boys"; 8-9, Christmas

carol service, Grace church; choir, direction of Mr. Clarence Mitchell, choirman, also through WEEL, WSAI, WGR, WWJ, WFL, WTAG, WOC, WCCO, KSD; 9-9:30, "The Larkinities" also through WEEL, WGR, WOC, WFL, WWJ, WCAE, WCAE, WCAE, WTAG, KSD; 9:30-10, "Surprise" program, also through WEEL, WGR, WOC, WFL, WWJ, WCAE, WCCO, WSAI, WTAG, KSD; 10-11, Goodrich Zippers, "O Wondrous Star," a story of the three wise kings in Bethlehem, also through WEEL, WSAI, WGR, WWJ, WOC, WFL, WCAE, WJAR, WADC, WTAG, KSD; 11-11:30, Metropolitan male chorus, Christmas program; 11:30-12, "A Christmas Carol," Charles Howard Mills reader, musical setting, presented by Alvin Silver company.
WEEL, Boston, Mass. (348.6), 6:45 a. m., Tower health exercises; 7:45, morning watch; 8 p. m., Lou Klayman and his orchestra; 6:45, Big Brother club; 7:40, "Measuring the Universe," Dr. Shapley; 8, New York Larkinities; 8:30, pop concert; 9, musicale; 10, Goodrich Zippers.
WFI, Philadelphia, Pa. (394.5), 10:15 a. m., reports; 10:30, solos; 1 p. m., tea room orchestra; 3, Sharon Hill club; 6:30, Bellevue Stratford concert orchestra; 7, Bellevue Stratford dance orchestra; 8, The Larkinities; 9, Chequoc club banjo band; 10:30, Goodrich Zippers.
WGBS, New York, N. Y. (315.6), 10-10:10 a. m., timely talks with Terese; 10:10-10:20, Alice Clark Barnhill, Better Homes and Gardens; 11:40-11:50, Hazel Lee, readings; 10:50-11, Jane Warren, pianist; 1:30-1:35 p. m., Scripture reading; 3-4, New York American in the Home program, Helen Ely, soprano; 6-6:30, Uncle George; 6:30-7:30, music; 8-8:30, Crystal Palace orchestra; 8:30-8:45, "Footlight and Lamplight," Oliver Saylor; 9-10, old time minstrels directed by Dalley Paskman; 10:30-11:30, Vanderbilt hotel orchestra.
WGCP, New York, N. Y. (252), 12:30 p. m., Mirror Race results and latest news items hourly throughout the day; 3-3:15, Elvira Rosa Geiger, pianist; 3:15-3:30, Frank Gallasi and Miriam Davis; 3:30-4, Harry Spear, singer; 4-4:15, Bert Dagmar, songs; 4:15-4:30, Gertrude Greenblatt, violinist; 4:30-4:45, Sylvia Schatz, pianist and elocutionist; 4:45-5:30, Joe Kahn's orchestra; 8:30-8:45, Eva Rothenberg, pianist; 8:45-9, Bert Dixon, baritone; 9-9:30, Strickland's orchestra; 9:30-9:45, Piotti and Val, songs; 9:45-10, Hughie Woolford, pianist; 10-10:15, Judith Roth, soprano; 10:15-10:30, Osborne and Meredith, songs; 10:30-11, Strickland's orchestra; 11-11:30, Connie's orchestra; 11:30-12, Murphy's entertainers.
WGH, Clearwater, Fla. (268), 6-7 p. m., Fenway hotel orchestra; 8:30-9:30, E. P. Pianco, program.
WGR, Buffalo, N. Y. (319), 2:30-4:30 p. m., WGR's afternoon program; 6:30, Vincent Lopez Hotel Statler dance orchestra, Harold Gieser, director; 8, jointly with WEAJ, including, the Larkinities, surprise program, and the Goodrich Zippers; 11, New Year's eve program.
WGY, Schenectady, N. Y. (379.5), 2 p. m., music; "The Family's Resources," Prof. Martha Van Rensselaer; 6:30, dinner program, Ten Jack concert trio; 7:30, book chat, William F. Jacob; 7:45, WGY orchestra; Viola Tuttle, soprano; 9, Royal hour, WJZ; Community Watch night service, Churches of Schenectady, First Methodist church; 11:55, Trinity chimes, WJZ.
WHAR, Atlantic City, N. J. (275), 2 p. m., Seaside hotel trio; 7:30, lecture period; 8, Seaside hotel trio; 9, vocal and instrumental concert.
WHN, New York, N. Y. (361.2), 12:30-1 p. m., Lexington organ recital; 3:15-4:30, Lexington orchestra; 6:30-6:40, Jack Cohen, pianist; 6:40-7, Sunshine talk, Billy B. Van; 7-7:30, Iceland dance orchestra; 8-8:30, WHI Oakland's Chateau Shanley; 10:30-11, Club Kentucky orchestra; 11-11:30, Joe Ward's Swane entertainers; 11:30-12, Bob Murphy's orchestra; 12-12:30 a. m., Ted Lewis and his orchestra.
WIP, Philadelphia, Pa. (508.2), 6:45 a. m., setting-up exercises; 7, setting-up exercises; 10, menu talk, Mrs. Anna B. Scott; 1 p. m., Gimbel tea room orchestra; 7:30, Artist recital, Freed School of Music; 6:05, Brunswick recording orchestra; 7, Uncle Wip's bedtime stories; 8, special New Year program; 10:05, Pagoda Cafe orchestra; 11, special New Year celebration, Independence hall; music by Philadelphia Police band, symphony orchestra; 12, tapping of the Liberty Bell ushering in the New Year.
WJR, Pontiac, Mich. (517), 7 p. m., Jean Goldkette's Petite symphony orchestra; soloists; 7:30, Ide and Meginnity; 9, Jean Goldkette's Serenaders, soloists; 11, Jean Goldkette's Victor Recording orchestra.
WLIT, Philadelphia, Pa. (394.5), 12:02 p. m., daily almanac; Stanley theater organ recital; Arcadia cafe concert orchestra; 2, Arcadia cafe concert orchestra; 4:30, recital; 7:30, Dream Daddy's bedtime stories.
WMCA, New York, N. Y. (340.6), 6-6:30 p. m., Olcott Vail and his Hotel McAlpin string ensemble; 6:30-7, Frank Gebbas, Red Lion Inn orchestra; 7-7:15, Violet Kaye Happy Girl; 7:15-7:17, Face Institute program; 7:17-7:30, Violet Kaye Happy Girl; 7:30-8, Lanson's orchestra; 8-8:30, Snedden, Weir, baritone; 8:30-9:30, Cinderella dance palace; 11-12, Ernie Golden and his Hotel McAlpin orchestra.
WNYC, New York, N. Y. (526), 7:10-7:30 p. m., dance program; 7:30-7:35, police alarms; 7:35-8, dance program; 8-8:30, song recital; 8:30-12, ninth annual entertainment and reception, Uniformed Firemen's Association of Greater New York.
WOD, Philadelphia, Pa. (508.2), 11 a. m., organ recital; 12, Golden's crystal tea room orchestra; 4:45 p. m., organ recital; 7:30, Hotel Adelphia French room orchestra.
WOR, Newark, N. J. (405.2), 6:15-6:30 p. m., Words often mispronounced; 6:30-6:45, sport talk, Bill Watney; 6:45-7:15, Jacques Jacobs Hotel Shelton ensemble.
WRC, Washington D. C. (468.3), 10 a. m., women's hour; 12m., organ recital, Homer L. Kitt studios; 1 p. m., W. Spencer Tupman's Hotel Mayflower orchestra.
WRVA, Richmond, Va. (256), 8 p. m., Ukulele club; 8:30, Old English carols, school children; 9, Arthur Perkins, one man Radio show; request numbers; 9:30, Anastasia Taylor, pianist; J. K. Bowman, contralto; 9:40, piano and violin solos; 9:50, Grey Garnet, tenor; Helen Lindsey, pianist; 10, contralto solos, J. K. Bowman; 10:10, Richmond jazz orchestra; songs and features; 11, Carry Me Back to Old Virginia.
WTAG, Worcester, Mass. (268), 10:30 a. m., musical selections; 10:45, talk, Marjorie Woodman; 12:05-2 p. m., luncheon music; 4:30, Indoor Sports club entertainment; 5:15, Twinkle Twinkle story teller; 7:45, nature talks, Esther Averill; 8-8:30, Larkinities, WEAF; 8:30-9, "Pop" concert, WEAF; 9-10, Chequoc Banjoists, WEAF; 10-12:30, Goodrich program, WEAF.
WTAM, Cleveland, Ohio (389.4), 12:15-1:15 p. m., lunch hour; 6-7, dinner hour music, Carl Rupp and his Hotel Hollenden orchestra.
WTIC, Hartford, Conn. (475.9), 6:30 p. m., Hub Restaurant trio; 7:30, talk.
WVJ, Detroit, Mich. (352.7), 9:30 a. m., "Tonight's Dinner"; 12:05 p. m., Jules Klein's Hotel Statler orchestra; 3, Detroit News orchestra; 6, dinner concert; 8, concert, WEAF.
Central Time Stations
KFEQ, Oak, Nebr. (268), 2-3 p. m., King's entertainers.
KFKX, Hastings, Nebr. (288.3), 1 p. m., "Legume Day-Clovers-Clovers-Which One Shall We Use?" John Pieper; 5:30, dinner concert, KDKA; 7, song of the Lazy Farmer.
KFMQ, Fayetteville, Ark. (299.8), 8 p. m., "Employing the Architect", B. N. Wilson; "Child Training-Causes of Backwardness in School", Helen C. Goodspeed; "The House on the Sand: Living on Borrowed Capital", A. W. Jamison; "Health-Play as a Rural Novelty", Irene Story; "The Aim of Education", J. B. Jewell; "Developing a Hydro-Electric Site", W. N. Gladson.
KFNH, Shenandoah, Iowa (266), 7 p. m., New Year's eve.
KPRC, Houston, Texas (296.9) 12 m. popular studio program, talks and music; 5:30, Uncle Judd's Kiddies' hour; 7:30, Blanchard's dance orchestra; 8:30-12, Watch party, KPRC entertainers; Tim Evans, announcing in Spanish.
KFRU, Columbia, Mo. (499.7), 12-2 a. m., musical program, Stephens college conservatory of music; Richard Silberstein, bass; Helen Richards, violinist; Glenn Davis, reader; Sewell Grinstead, flutist.
KLDL, Independence, Mo. (441), 8 p. m., Mrs. Rudolph T. Wickman, soprano; Mildred Woolman, violinist; Emily Cox, pianist; "Can We Do What We Please," Dr. P. M. McDowell.

FANS TO HEAR POETS THROUGH WTIC

Thursday, December 31

KMA, Shenandoah, Iowa (252), 12 m., May's Flower Lady, Lina Ferguson; 4 p. m., travelog, G. H. Van Houten; 6-7, music; 9-11, Delmonico Dreamers hotel orchestra; vocal solos, Eugene Haglund; 1-3 a. m., New Year's eve program.

WMAQ, Chicago, Ill. (447.5), 12:45 p. m., farm school; 2, shut-in program; 4, Illinois Federation of Women's clubs program; 4:45, musical program; 5:15, Topsy Turvy time; 6, Chicago theater organ recital; 6:30, Wide-Awake club; 8, Mr. and Mrs. Marx E. Oberndorfer, musical lecture; 8:30, Whitney trio; 9, University of Chicago lecture; 9:20, Elizabeth Stokes soprano.

WMBB, Chicago, Ill. (250), 7-8 p. m., Trianon duo, Frank Sarney, tenor; 9-11, Trianon orchestra; Woodlawn theater orchestra; Tracy and Duncan, Scotty Welsh, Madison Sisters.

WJAZ, Chicago, Ill. (322.4), 10 p. m., chimes; classical program, E. Warren K. Howe, director; Florence Smith, contralto; William Hayden, tenor; Laura Turner, soprano; Edward Martin, bass; George Smith, baritone; Joseph Brinkman, pianist; Adalbert Huguleit, pianist; Act III of "Faust"; Zenith opera company, selections from operas; Drinking songs of Ye Olden Times.

Friday, January 1

Table with 4 columns: Eastern, Central, Mountain, Pacific. Lists radio stations and their programs for Friday, January 1.

Friday, silent night for: CFAC, CHIC, CKNC, CNRC, CNM, CNRO, CNRW, KFDJ, KFEQ, KFMQ, KFUO, KFWA, KFXE, KGO, KLDL, KMA, KPRC, KSD, KUOM, PWX, WAFB, WBAI, WBBR, WCAP, WCBP, WCBW, WCX, WEAF, WEAQ, WGBS, WGR, WHAS, WHAZ, WHN, WIP, WJAR, WJAZ, WKRC, WLW, WMAQ, WNBC, WNYC, WOR, WOS, WREO, WRVA, WSAI, WSM, WSUI, WSMB, WTAG, WTAM, WTIC.

Eastern Time Stations
KDKA, Pittsburgh, Pa. (309.1), 7:15-8 a. m., exercises, O'Shannon; 10, domestic science and arts for the housewife; 12:20, Sunday school lesson, James Mace; 5:45, Auntie Jim's letter from across the Sea; 6:30, dinner concert; 8:30, Teaberry time.

Mountain Time Stations
CFAC, Calgary, Can. (435.8), 7 p. m., bedtime story; 10-12, Canadian National Railways program; orchestra, Gladys Webb Foster, director; George Burrell, tenor.

Pacific Time Stations
KFWA, Ogden, Utah (261), 4-5 p. m., organ recital, Paramount theater; 5-6, Ogden Radio Dealers program.

WJAZ, Chicago, Ill. (322.4), 10 p. m., chimes; classical program, E. Warren K. Howe, director; Florence Smith, contralto; William Hayden, tenor; Laura Turner, soprano; Edward Martin, bass; George Smith, baritone; Joseph Brinkman, pianist; Adalbert Huguleit, pianist; Act III of "Faust"; Zenith opera company, selections from operas; Drinking songs of Ye Olden Times.

WMAQ, Chicago, Ill. (447.5), 12:45 p. m., farm school; 2, shut-in program; 4, Illinois Federation of Women's clubs program; 4:45, musical program; 5:15, Topsy Turvy time; 6, Chicago theater organ recital; 6:30, Wide-Awake club; 8, Mr. and Mrs. Marx E. Oberndorfer, musical lecture; 8:30, Whitney trio; 9, University of Chicago lecture; 9:20, Elizabeth Stokes soprano.

WLIT, Philadelphia, Pa. (394.5), 12:02 p. m., daily almanac; Arcadia cafe concert orchestra; Stanley theater organ recital; 2, Arcadia cafe concert orchestra; 4:30, recital; 7:30, Dream Daddy's bedtime stories; "Sunbeam Party"; 8:30, concert, Witherpoon hall; 10, Morning Glory club concert; Arcadia cafe dance orchestra; 10:30, "Rufus and Rastus," songs and chatter.

Central Time Stations
KFDL, Beaumont, Texas (315.6), 12:25-12:55 p. m., band concert; 7-7:30, children's program; 8:10-8:30, band concert, Magnolia Petroleum company's Refinery band.

WMAQ, Chicago, Ill. (447.5), 12:45 p. m., farm school; 2, shut-in program; 4, Illinois Federation of Women's clubs program; 4:45, musical program; 5:15, Topsy Turvy time; 6, Chicago theater organ recital; 6:30, Wide-Awake club; 8, Mr. and Mrs. Marx E. Oberndorfer, musical lecture; 8:30, Whitney trio; 9, University of Chicago lecture; 9:20, Elizabeth Stokes soprano.

WMAQ, Chicago, Ill. (447.5), 12:45 p. m., farm school; 2, shut-in program; 4, Illinois Federation of Women's clubs program; 4:45, musical program; 5:15, Topsy Turvy time; 6, Chicago theater organ recital; 6:30, Wide-Awake club; 8, Mr. and Mrs. Marx E. Oberndorfer, musical lecture; 8:30, Whitney trio; 9, University of Chicago lecture; 9:20, Elizabeth Stokes soprano.

WMAQ, Chicago, Ill. (447.5), 12:45 p. m., farm school; 2, shut-in program; 4, Illinois Federation of Women's clubs program; 4:45, musical program; 5:15, Topsy Turvy time; 6, Chicago theater organ recital; 6:30, Wide-Awake club; 8, Mr. and Mrs. Marx E. Oberndorfer, musical lecture; 8:30, Whitney trio; 9, University of Chicago lecture; 9:20, Elizabeth Stokes soprano.

WMAQ, Chicago, Ill. (447.5), 12:45 p. m., farm school; 2, shut-in program; 4, Illinois Federation of Women's clubs program; 4:45, musical program; 5:15, Topsy Turvy time; 6, Chicago theater organ recital; 6:30, Wide-Awake club; 8, Mr. and Mrs. Marx E. Oberndorfer, musical lecture; 8:30, Whitney trio; 9, University of Chicago lecture; 9:20, Elizabeth Stokes soprano.

WMAQ, Chicago, Ill. (447.5), 12:45 p. m., farm school; 2, shut-in program; 4, Illinois Federation of Women's clubs program; 4:45, musical program; 5:15, Topsy Turvy time; 6, Chicago theater organ recital; 6:30, Wide-Awake club; 8, Mr. and Mrs. Marx E. Oberndorfer, musical lecture; 8:30, Whitney trio; 9, University of Chicago lecture; 9:20, Elizabeth Stokes soprano.

WMAQ, Chicago, Ill. (447.5), 12:45 p. m., farm school; 2, shut-in program; 4, Illinois Federation of Women's clubs program; 4:45, musical program; 5:15, Topsy Turvy time; 6, Chicago theater organ recital; 6:30, Wide-Awake club; 8, Mr. and Mrs. Marx E. Oberndorfer, musical lecture; 8:30, Whitney trio; 9, University of Chicago lecture; 9:20, Elizabeth Stokes soprano.

WMAQ, Chicago, Ill. (447.5), 12:45 p. m., farm school; 2, shut-in program; 4, Illinois Federation of Women's clubs program; 4:45, musical program; 5:15, Topsy Turvy time; 6, Chicago theater organ recital; 6:30, Wide-Awake club; 8, Mr. and Mrs. Marx E. Oberndorfer, musical lecture; 8:30, Whitney trio; 9, University of Chicago lecture; 9:20, Elizabeth Stokes soprano.

WMAQ, Chicago, Ill. (447.5), 12:45 p. m., farm school; 2, shut-in program; 4, Illinois Federation of Women's clubs program; 4:45, musical program; 5:15, Topsy Turvy time; 6, Chicago theater organ recital; 6:30, Wide-Awake club; 8, Mr. and Mrs. Marx E. Oberndorfer, musical lecture; 8:30, Whitney trio; 9, University of Chicago lecture; 9:20, Elizabeth Stokes soprano.

STATIONS IN ORDER OF WAVE LENGTHS USED

Table with 6 columns: Meters Call, Meters Call, Meters Call, Meters Call, Meters Call, Meters Call. Lists radio stations and their call letters in order of wave length.

(Continued on page 30)

Radio Digest Illustrated

Reg. U. S. Pat. Off. & Dom. of Canada

Published by the

RADIO DIGEST PUBLISHING CO.,
(Incorporated)

510 North Dearborn Street
Chicago, Illinois

Telephones: Superior 7323, 7324, 7325, 7326, 7327

E. C. RAYNER, Publisher

Eastern Office, Park-Lexington Building, 247 Park Ave.,
New York. Telephones: Ashland, 8144, 8145, 8146

Member of the Audit Bureau of Circulations

241
PUBLISHED WEEKLY

SUBSCRIPTION RATES

Yearly in U. S. and Possessions and Canada, \$5.00

Foreign postage, \$1.00 additional. Single copies, 10 cents.

Vol. XV Saturday, December 26, 1925 No. 12

What a Listener Thinks

HUNDREDS of letters arrive on the editor's desk. Many readers write him. Now and then, however, one is striking. Such is one just received from "just a Radio nut," as he styles himself, living in Florence, South Carolina, on the eastern seaboard.

It pleases us to receive such letters. Read what he says. See what criticisms he has to make. Note what he has been able to do with a MERE single circuit regenerative set, coupled with a Thatcher non-radiating radio frequency unit, so that he won't annoy his neighbors.

His letter follows:

"Just a few lines from an old subscriber and 'Radio nut' as to the improved, also DX reception we are now getting, as compared with some years ago when we first started in the game. I compare results by receiving with my pioneer set, a single circuit regenerative, and all praise is due to the transmitting stations. Here's hoping we can finally eliminate the interference between stations. I have a superselective set that can cut out anything except the wave heterodynes, and they are painfully common of late.

"The 5,000-watt supers get through in great shape. Also the new Western Electric outfits, 1,000 to 2,500 watts, I believe, give wonderful results. I get California stations almost any night as soon as they come on, and do not have to wait for eastern stations to get off the air, as formerly. I can even tune in KFI some nights with WRC or WCAP roaring nearby. Of course general reception has to be fair for such results.

"My favorite set is the Thatcher radio frequency unit, described in your issues, coupled to my old single circuit regenerative. I have tried about all the new hook-ups and manufactured sets, but with a good aerial the above brings home the bacon well enough. Have been getting daylight reception (10 a. m. to 3 p. m. in bright sunshine), for the past sixty days, or since cool weather arrived.

"I enjoy distant sermons and football games, things I have never before been able to get successfully in daylight. I travel most of my time, or could perhaps give some better reception facts. The following stations come through plainly some days, as above, even for loud speaker reception, and better at night, accordingly:

• "KDKA, WLIB, WHT, WGY, WBZ, WSB, WSAI, WLW, WWJ and WEAJ.

"KDKA's morning setting-up exercise comes in with night time loudness, and more clear and free of static.

"I am sending a copy of this letter to the interested stations, with congratulations, and hopes for their long life and happiness, in exchange for the pleasure they render us.

"KFI, KNX and KGO are the reliable California stations, I find. Also the stations in Texas, Arkansas, Missouri, Nebraska, etc., come in far better since they have increased power.

"I was not much impressed with the 50,000-watt transmissions by WGY. I suppose I was expecting too much. I have not listened to WJZ with its new high power from Bound Brook, but am on the look out for it; WJZ has been impossible at its old location in New York city.

"I am sold on the short wave transmission by KDKA and WGY. It eliminates most of the static and fading trouble and comes in with fine volume and clearness. "The paid advertising programs seem to be getting better, and we are strong for them, as long as they keep the high standard of quality up."

The writer of the above letter has covered much ground. What is important, he has discussed the subjects from the standpoint of the average broadcast listener. We are glad to reprint what he has written for the benefit of other readers and the broadcasters, mentioned or not.

Radio transmission is improving; 50,000 watts hasn't proven itself worth while yet; a single circuit set with a Thatcher unit brings "home the bacon"; interference between stations is still very bothersome; paid advertising programs are getting better.

Do we all agree with him?

RADIO INDI-GEST

The Lost Station

(With ordinary apologies.)

Seated one day at the Radio
I was weary and ill at ease,
And my fingers wandered listlessly
Over the dial of the coupler keys.

I knew not what I was getting
From that thing with ethereal wings,
But I struck one station astounding—
Oh! What sadness and heartaches it brings.

It came in with perfect reception,
Like it was only a mile away
Then I felt like one feels with a million
As I sat there that gloomy old day.

For five or ten minutes I listened,
Then from the skies—what a blow
The announcer was speaking—
My God! What's that? Lon-Don-Two-eL-O!

Curses it then faded away like a dream
Sadness and gloom filled the air.
Oh! How I have tried to re-get them
And I know they're there and not there.

Some day I shall locate that lost station!
When I do it shall be mine to keep.
For I've a dictaphone placed by my set
And I'll get 'em regardless of sleep.

H. L. D.

Maybe that was during the football season and what you heard was, "one down, two tuh gc." Have conferred with Dielectric and he suggests that if you and your dictaphone don't get 2LO, enlist Scotland Yard.

Trying for 1,000 Islands?

Dear Indi: I just read in your magazine that Mrs. Flossie Erickson of Bloomington, Ill., has logged 240 stations. I believe I have had more than that all at the same time, just now, while trying to tune in a station, and no kidding about it. E. C. L.

Which goes to prove there is no place like home.

Chicago Undertaker Finds Broadcasting Helps His Business

—From WBCN News Notes.

You should be dying to hear him, he is evidently perfectly killing.

Eskimos Are Fortunate

"Explorer MacMillan gave the Eskimos at Etah a chance to talk into the microphone, while others listened in. And the marvel of it is they enjoyed it, though the Eskimos are limited, according to all accounts, to 40 words in their language. If they can make themselves understood with 40 words, why not tie some of our highbrow after-dinner speakers down to that limit?"

—Thoughts of an Eavesdropper,
in Columbus, Ohio, Dispatch.

A good suggestion from the "Eavesdropper" and right now we will cast the first vote to make Eskimo-ese the international Radio language, providing announcers are not allowed to use the same word twice.

Getting Ahead

Dear Indi: Dr. Galdston in a Tower Health talk on headaches over WEAJ expressed, "A headache indicates that the human engine has become overheated." Do you think this is caused by running around too much? DEE TEE.

Yes, Dee Tee, that could cause it if you stepped on it and traveled at too fast a clip, and undoubtedly does cause it if you put alcohol in your radiator.

In for the Night

I've heard of people raving
Of stations they can hear—
KFI and KNX,
From 'cross the pond and near.

These things they do not thrill me,
Not even 2LO,
Or hear a band from a far-off land
Or a shrieking soprano.

No, 'Im not an ether traveler
When by my set I sit
When I get my favorite station,
I stay until they quit.

That Red Head Gal, Bobette.

Dear Bobette: The greatest thing in the world is a constant and enduring love, but as you live in Chicago, we would warn you against any affinity toward KYW. They have a 24-hour program and even the milkman couldn't save you.

Vive la Suffrage

Dear Indi: Recently one of the leading men's tailors of Los Angeles announced the winner of a contest that had been held over the air. The announcer, opening the winning letter, told that "Miss _____ had won the contest and would receive an order for \$25 pair of pants." P. W. B., Los Angeles.

At that, \$25 don't go a very long way these days.

News of the Week



Condensed BY DIELECTRIC

It may have been difficult for some in the Radio audience listening to WNAC, Boston, as that station broadcast the play, "The Miracle," from the Boston opera house, to follow the action and imagine the stage effects, yet to all came the strains of music as vividly illustrative of the plot as any Wagnerian motifs. Undoubtedly the grandeur of a work of this kind is lost to unseeing auditors but so much of it is obtainable that we are very much indebted to Mr. Gest and the Shepard Stores for again broadcasting this masterpiece. The description of the development of the play was helpful and lucidly given while the music composed for the work was exquisitely played.

Station WSAI, Cincinnati, is utilized for presenting a community plan of broadcasting entertainment by first-class artists which apparently has interested listeners in all parts of the country. On one of the evenings devoted to this feature I found myself rubbing dials with governors of many states as well as other notables who made up the cosmopolitan audience enjoying a program given by the Cincinnati symphony orchestra. This series constitutes another link in the growing chain of unusual performances to which all broadcast listeners are invited.

Many of the colleges are broadcasting material of great practical value to countless men and women deprived otherwise of special knowledge. The lighter side of university life and its fraternal spirit was exemplified in the broadcasting by WLIB, Chicago, of the Northwestern university banquet of alumni. Speeches and songs were bolstered up with yells and general jollity impressing listeners with the comradery of fellow students. It may be said that these features have too much of local interest, but I venture to say there are few of us listeners who do not enjoy their enthusiasm.

Very pleasing, indeed, was the concert broadcast by Station WPG, "The World's Playground," Atlantic City, presented in the high school auditorium of that Atlantic coast resort, enabling listeners to hear a selection of popular instrumental numbers rendered by harp, cello, violin and flute artists. Especially pleasing was an effective arrangement of "The Rosary" played by these artists. Distant auditors must have been as willing to applaud as those seated in the auditorium and it is hoped they did so in the only manner possible—writing their applause.

Kathryn Meisle, who sang in the Atwater Kent hour from WEAJ, New York, displayed a quality of contralto none too prevalent among concert singers and for that reason, if no other, she should be heard by Radio listeners again. Comparable to famous contraltos of past operatic history in the peculiar timbre of her vocalizing, we should be proud with her of such attainment with exclusive American tutelage. Allen McQuhae endeared himself by singing Irish songs in true Erin style. These two artists added much to the series.

A good program of dance numbers is never unwelcome but a surfeit of jazz comes with greater or less alacrity, depending upon the listener. I have found few dance programs more completely satisfying throughout than one from the studio of KOA, Denver, recently offered. "I'm Smiling Through My Tears" was one of the numbers played with grace and tonal beauty though every number had its own appeal. We'll travel there again.

Installation and Care of the Christmas Set

Part I—Antenna and Ground Suggestions

By John G. Ryan

THE MAN who is presented with a new receiving set, and who has not previously installed or operated one is very apt to be somewhat bewildered by the number of controls and the accessories which must be connected to the receiver, and taken care of. While the manufacturer has probably furnished a book of operating instructions, the matter of installing an aerial and ground will be somewhat confusing.

Practically all of the receivers which will be given this year are of the 5-tube type known as tuned radio frequency, or the larger type known as super-hetero-

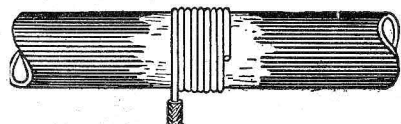

Figure 1—Should ground clamp be not readily accessible, connection can temporarily be made this way.

dyne. The first of these two types requires an outside wire from 40 to 100 feet long, including the wire which comes down to the receiver itself. In localities where there are a great number of broadcasting stations, such as Chicago, New York or Los Angeles, the shorter antenna will give much more satisfactory results because of the increased selectivity or ability to separate stations, which the shorter aerial provides. The antenna proper is usually strung between two chimneys, in the case of the user living in an apartment house, while the Radio set owner who lives in the usual two-story house finds it more convenient to string the aerial between his roof and that of a neighbor. The best height for an antenna is 30 to 40 feet above the ground, as experiments have shown that at this height much less static is picked up.

The type of wire used for an antenna is not extremely important, except that it be made of copper, and it may be cotton covered, bare or coated with enamel.

The Belden company has a very excellent wire for this purpose, covered with a heavy layer of enamel which is available all over the country, and the new Radio set owner will not go wrong if this wire is used.

Insulators Are Important

It is important that a small insulator be inserted at each end of the wire, between the wire actually used and that which is put in for the purpose of separating it from the chimney. The lead-in may very well be a continuation of the actual antenna itself or it may be a rubber covered wire soldered to the antenna, between the insulators and close to one of them. This lead-in wire should be kept clear of the building where it comes down from the antenna by means of more insulators and these insulators can be of porcelain, glass, or bakelite. Where the lead-in wire is brought in through the house, it should preferably be brought through a porcelain tube which can be had from any electrical or Radio supply store.

The ground connection is usually made to a cold water pipe, by scraping the corrosion and dirt from the pipe for a length of about two inches, and fastening a ground clamp (costing about 20c) on the pipe at this point. A wire is then connected to the ground clamp and carried to the receiver for connection to the binding post inserted for that purpose. In the case of the country resident it may be necessary to drive a long rod into the ground to a depth of four to six feet and fasten the ground wire to it either with a clamp or a machine screw inserted into the pipe by means of a drilled and tapped hole. The ground wire should be run as direct as possible so that it will not be too long, and it should, preferably, be insulated.

Super-Het Uses Loop

The owner of a super-heterodyne does not have this antenna problem as this type of set will function on a small framework of wire known as a loop aerial. It is not advisable to try to con-

struct a loop as one can be purchased at a very low cost and will look better and operate better than anything which the home builder might put together.

The Radiola super-heterodyne requires a special loop aerial and several concerns are now making a loop of this capacity.

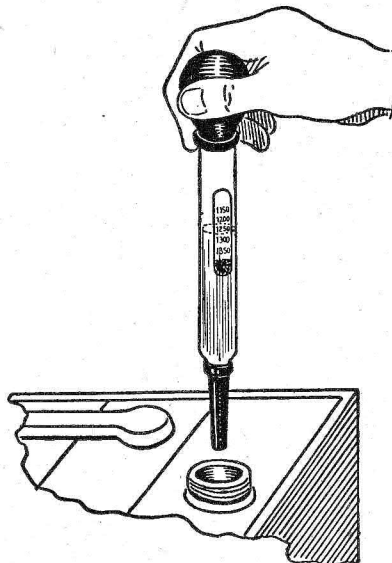

Figure 2—The hydrometer and its use are shown here. Reading should be taken with hydrometer held vertically.

The Radio Corporation of America manufactures such a loop, of course, and this special size is also available under the name of Bodine and as the Aero loop. Other super-heterodyne sets usually take the standard loop such as is used on re-

flex receivers and many types of tuned radio frequency outfits.

Batteries Necessary

All Radio receivers require what is known as an A battery, and also a set of B batteries; most of them also need a small unit known as a C battery. The A battery may be either a storage battery such as we usually find on automobiles, or it may be 3 dry cells such as are used on doorbells. The type of A battery necessary is determined by the type of vacuum tubes used. If the manufacturer's instructions state that the tubes are to be of the 201-A type, a storage battery giving six volts is needed. If the tubes are of the 199 class, they can be lighted from three dry cells such as the Columbia Ignitor, or the Eveready Special Radio A cell. Practically the only receiver now on the market which does not use one or the other of the above mentioned tubes, functions from dry cells but the cells are not connected in the same way that they would be to light the filaments of the 199's.

B batteries are the same for any type of receiver but they come in various sizes which determines the length of life, but not the voltage. It is good economy to purchase a large size B battery as the larger sizes have a length of life far greater than their proportionate cost to the smaller batteries. The Eveready number 486 is recommended for any installation and if the receiver is a single tube affair, it will require but one of these units, while, if it contains from 2 to 8 tubes, two or three of these units will be necessary. B batteries are also made in storage cell types and while these are rather expensive as to initial cost, they are probably somewhat cheaper over a long period of time. They can be readily recharged at low cost about once

(Continued on page 24)

A CHRISTMAS SUGGESTION

Fultone

Trade Mark

THE FORD of LOUD SPEAKERS
\$6.50

Fultone Loud Speaker has conclusively proven to the radio world that a reproducer could be made and sold at \$6.50 which would handle music or speech in volume as perfectly as any speaker at any price. The horn is solid, non-ringing and wide-throated enough to handle the powerful reproduction from super-heterodyne or reflex. The adjustable diaphragm permits matching Fultone to any receiver and "B" battery voltage.

Either speaker or unit will be shipped on a satisfaction or money back basis on receipt of price in money order or currency. The coupon is provided for your convenience in ordering if your dealer cannot supply you.

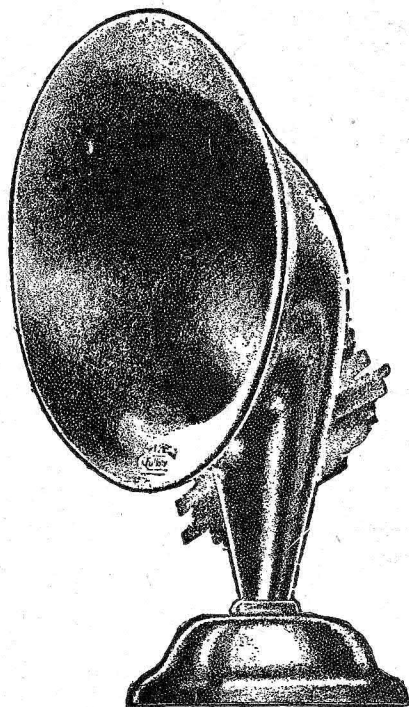

Fultone

Trade Mark

LOUD SPEAKER UNIT
\$3.00

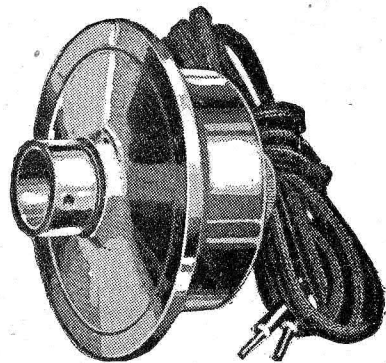

Its large diaphragm and bobbins of fine wire are protected from injury by a heavy nickel-plated case through the means of a special key. The pole pieces are not made from a solid piece of iron but are assembled from 15 laminations of carefully chosen steel.

Use on Your Phonograph
Edison Adapter.....25c
Columbia or Pathe.....20c
Brunswick.....30c

HALL & WELLS, Inc.
128 N. Wells St. Chicago, Ill.

This unit is the secret behind the unparalleled success of Fultone Speaker. Each of which adjustment is made by

Tear Off, Fill in, Mail Now

HALL & WELLS, Inc. 128 N. Wells Street, CHICAGO, ILL.
Enclosed is \$.....for which ship me () Fultone Speaker.....() Fultone Unit at once, my money to be refunded if I am not satisfied and return this merchandise within 5 days.
NAME.....
ADDRESS.....
CITY AND STATE.....

4 Big Improvements in Amplification!

- 1 Full amplification of those bass notes hitherto largely "lost".
- 2 Greater clarity on all notes.
- 3 Improved reception of distant programs.
- 4 Better volume control.

A Thordarson Autoformer Amplifier built in accordance with instructions and diagrams furnished with each instrument.

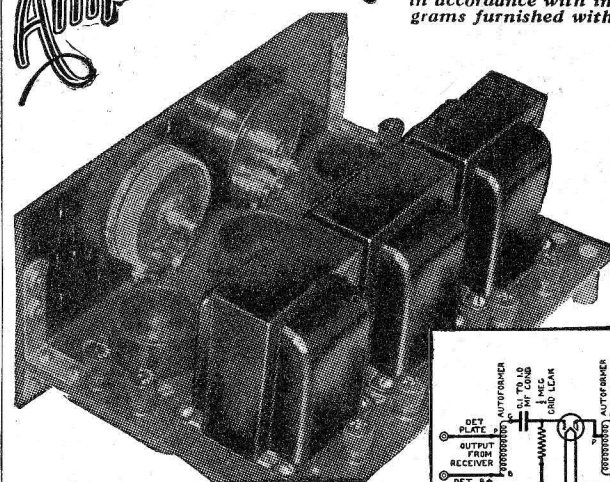

fans!

Send for our new interesting bulletins on Autoformer amplification. They contain hook-ups and complete directions.

No note is too low—no note is too high—to be fully amplified by Thordarson Autoformers. Autoformers are all frequency amplifiers—they amplify with even magnitude ALL notes within range of the human ear. Developed, perfected and built only by Thordarson.

THIS latest Thordarson development—the Autoformer—utilizes for the benefit of your radio set, the same principle used in the line amplifiers adopted by the more recent high-powered broadcasting stations. The excellent tone quality of these stations—due to perfect amplification—offers proof of Autoformer effectiveness.

Autoformer amplification is for those who seek the finest reproduction of programs to be had. May be used with any set in place of regular audio transformer hook-up. Full directions, with diagrams, supplied with each instrument. Autoformers are \$5 each.

Sold by the Leading Dealers

THORDARSON ELECTRIC MANUFACTURING CO.
Transformer specialists since 1895
WORLD'S OLDEST AND LARGEST EXCLUSIVE TRANSFORMER MAKERS
Chicago, U.S.A.

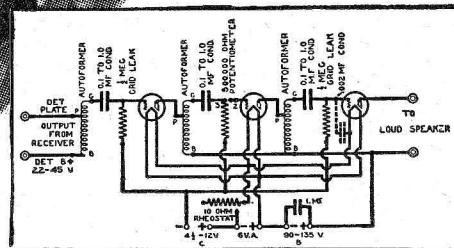

"WLIT 'DREAM DADDY' "

(Continued from page 7)

was born in Chicago, enlisted at the Great Lakes station, and was shipped east. On his way back from Europe he stopped off at Philadelphia, landed a job with Station WIP, and has been in the Quaker City ever since.

Of course, there is a program director, and those who have listened to the excellent classical programs broadcast by WLIT can thank Mrs. B. F. Maschal, who is very well known in musical circles throughout the country. She is an executive of the Matinee Musical club, the largest club of its kind in the country; a member of the board of the Philadelphia Civic Opera company, and a national board member for eastern Pennsylvania of the National Federation of Music clubs. Her acquaintanceship with many noted musicians, has enabled this station to broadcast musical features of high quality.

When "Dream Daddy" became station director, the destinies of operation fell on the shoulders of James Nassau, known as announcer "J.A.N.," and a brother of Joseph Nassau, of Station WOO. "Jimmy" is a dyed-in-the-wool Radio fan, and like the motorman who takes a trolley ride on his day off, he works his low-wave set, and tries to "raise" some fan in far-off Chile or Peru, when he is not on duty at the station. Horace Shivers is next in charge of the operating room, and to say he is capable is putting it mildly.

Allyn C. Saurer is the "remote control" man of the station, and it is his voice you hear when the Arcadia concert orchestra broadcasts a concert every day. Besides, he broadcasts a dramatic review every Tuesday evening and conducts the "Morning Glory" concerts every Friday evening. These concerts are epics to those who love the popular type of program, and after each concert comes hundreds of letters from all over the country.

Probably the most stable feature of WLIT is the "Stanley Hour of Music," broadcast every Monday evening. It is done direct from the stage of the magnificent Stanley theater in Philadelphia. It usually consists of selections by the symphony orchestra, largely composed of members of the Philadelphia orchestra, and selections by a nationally famous dance orchestra, or songs by some well-known vocalist. Another exceptional and popular feature is Rufus and Rastus, a team of "Dark Clouds with a Silver Lining," who dispense good cheer every time they go on the air, and who have, by the

way, a repertoire of one thousand songs. They also form half of the Fireside quartet, a regular feature.

The latest control of WLIT is Wither- spoon Hall, where some of excellent musical concerts are given. Always having in mind the listener in, only those concerts that are considered the proper material for the average fan are chosen by Mrs. Maschal, who, as we have said before, has a keen sense of judgment in matters musical.

The station broadcasts on 394.5 meters, and uses both storage batteries and generator for its power. The aerial towers are 400 feet above street level.

YOUR CHRISTMAS SET

(Continued from page 23)

every three weeks, and with a little care should last for several years. Excellent storage B batteries are made by Prest-O-Lite, Willard, World and Philco.

Care of Batteries

The above mentioned batteries are all of the sulphuric acid type, but storage B units are also made using alkali solution instead of acid. Probably, the best of these is put out under the name of Hawley, by a concern in Danbury, Connecticut. These alkali batteries cannot be injured electrically, and do not require quite the careful attention that the acid type of storage B must have.

There is only one method of testing the storage A battery, which, while it is rather mussy, must be done at frequent intervals if the battery is to function properly and enable your receiver to give satisfactory results. A device called a

Hydrometer can be obtained at Radio and automobile supply stores and consists of an outer glass tube, an inner glass float and a rubber bulb. The small tip on the end of the outer glass tube is inserted through one of the holes in the top of the battery, sufficiently so that it is below the level of the liquid within. The rubber bulb is then squeezed and released, which will draw liquid up into the outer glass tube. The small glass float will then rise to the surface of the liquid in the hydrometer and the condition of the battery is determined by the number on the side of the float which is at the level of the liquid.

There is a scale in the float reading from 1100 to 1400, and if the surface of the liquid is between 1100 and 1150 the battery is pretty well discharged, while if it reads between 1250 and 1300 the battery is charged and ready for use. When the reading has been taken, the liquid is then squirted back into the cell from which it was taken. The only care necessary for this battery is that distilled water be added to the cells to keep the level just above the top of the plates. This can be observed by looking down through the hole in the top of one of the cells and the distilled water can readily be added with the hydrometer. Nothing else should ever be added as the acid does not evaporate.

The vacuum tubes of any type should be handled very carefully as the interior construction is very delicate and a severe jar would bend them out of their allotted places, and, while the glass may not be broken, the efficiency of the tube would be seriously impaired. You will note

when unpacking them that the tubes are carefully wrapped in corrugated board and a soft cottony material. In the majority of receivers of from 5 to 8 tubes, the tubes are all of the same type, but there are a few sets now on the market which require a special tube in the third socket such as the UV-200 or a special tube in the last socket such as the new UX-112. The writer made a mistake recently and tried to operate a receiver with a UX-120 in the wrong socket, and searched for an hour to find the cause of the distortion. The power tube used in the last socket is to be the UX-112 if the rest of the tubes are of the 201-A type, and should be the UX-120 if the rest of the tubes are of the 199 class. There is no power tube for use with WD-11 tubes.

So much for accessories, and in the next issue we will take up the connections to the receiver of the accessories, and will discuss loud speakers.

By running a wire from the receiving set to head phones in another room, it is possible for persons some distance from the set to enjoy concerts. When confined to bed by illness or permanent injury, this is an excellent means of bringing entertainment to their bedside.

Conversational French is being taught through Station WGY in a course of lessons which began recently. The instructor will be Leon A. Huguemont, a native of Aix-les-Bains, Savoy, France, and now an electrical engineer in the employ of the General Electric company.

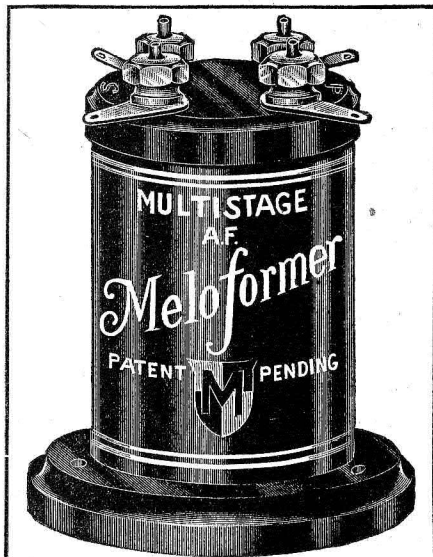

Powerful Rich Tones

ARE to be expected when Meloformers are installed in the audio circuit of any set.

The straight "8" super, built and fully described in this issue by Christen & Fournier verifies, to the fullest extent, the findings of radio engineers everywhere.

Install them in your set—whether it be a Super or not—and note what clear, rich tones the Meloformer produces.

For Sale at All Dealers at \$4.00 each

MELOFORMER SALES CO. National Distributors 9 S. Clinton St. Chicago

Manufactured by ROBERTSON-DAVIS CO., Inc., 412-420 Orleans Street, CHICAGO



for Audio Amplification

The New Radio Book HOW TO

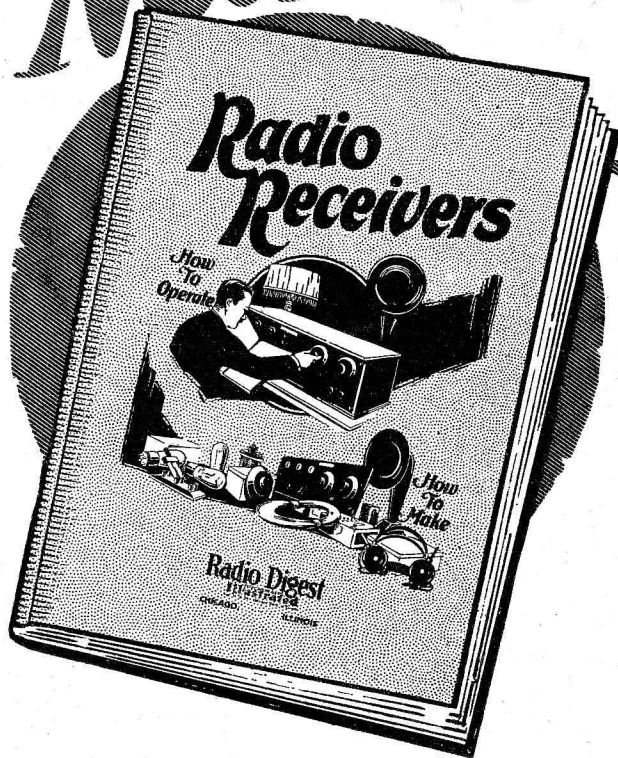

Operate Sets Construct Parts Improve Reception Understand Radio Assemble Circuits

FREE With One Year's Subscription to Radio Digest

THE greatest assemblage of facts and hints, from actual everyday practice, ever gotten together. Edited by the technical staff of Radio Digest it supplies the demand for a book covering every phase of Radio from a simple explanation of Radio reception to a technical explanation of the different parts of a set which leads to the best reception possible. The sections on selecting and making sets develops the different types of sets and circuits with blue-prints and diagrams to explain same. "How to Operate" gives detailed information on the operation of all the well-known sets. The section of general information contains a complete Radio map and schedule and a section of workshop kinks which save time and money. Now is the time to take advantage of the exceptional offer as listed in the coupon for your convenience.

RADIO DIGEST, 510 N. Dearborn St., Chicago, Ill. 12-26-25

Enclosed find five dollars for one year's subscription to Radio Digest including FREE the New 124 Page Radio Book called "Radio Receivers—How to Operate and How to Make."

NAME.....

ADDRESS.....

CITY..... STATE.....

This Handy Radio Reference Book Is Yours Today

Use the Coupon—Mail Today

Straight-8: Outside Aerial Tuned R.F. Super

Part II—Panel Drilling and Assembling

By A. Christen and Jacques Fournier

IN THE first article of this series, the writer discussed the various parts used and the reason for their choice. Presuming that we now have all these parts available, or on the way, we can take up the layout of the front panel and that of the sub base, and the mounting of the apparatus on these panels.

Regular readers of Radio Digest have probably noticed by this time that it is the practice of this paper to always have a bakelite sub base mounted on brackets in preference to a wooden base board secured to the panel with wood screws. There is no questioning the superiority of bakelite for this purpose since wood absorbs moisture which will cause leakage if any live parts happen to be in contact with it. The use of a bakelite sub base also has the advantage that parts can be mounted beneath it where they should be in close proximity to certain other units but there is not sufficient space on the upper surface. Then too, much of the wiring can be put below the sub base, which materially improves the appearance of the inside of the receiver and frequently also is an aid to efficiency. In this case, this practice enables us to mount the coupling transformer between the first and second tubes, close to their sockets, yet not in such a position that it is likely to feed back into the transformer used to couple the antenna to the receiver. It also permits us to mount the second audio transformer close to the last two sockets yet not crowd the upper surface of the sub base.

Full Size Templates Available

The reader can either make his own templates, following the dimensions given in figures 5, 6, and 7, or can write in to Department 5, Radio Digest, 510 N. Dearborn St., Chicago, and secure full size drilling templates for 25c. These templates are available for all receivers presented by the Digest, as there are many readers who feel competent to construct their own receivers but are not so sure of their ability as draftsmen.

Considering now figure 5, which is the layout for the front panel, the 30-ohm rheostat is placed in the first hole to the left about mid-way the height of the panel. The next hole on this line is to be drilled $\frac{1}{2}$ inch in diameter for the mounting of one of the Karas condensers. In this case, we have chosen to mount it by means of the single hole mounting feature instead of the three hole mounting arrangement. Near the top edge, and in the center of the panel lengthwise, there is a $\frac{1}{8}$ -inch hole for a four spring jack. The other $\frac{1}{2}$ -inch hole is for the second Karas condenser and the hole at the right end is for another 30-ohm rheostat. In the lower left corner of the front panel, there are two holes each $\frac{1}{8}$ inch in diameter, and the single

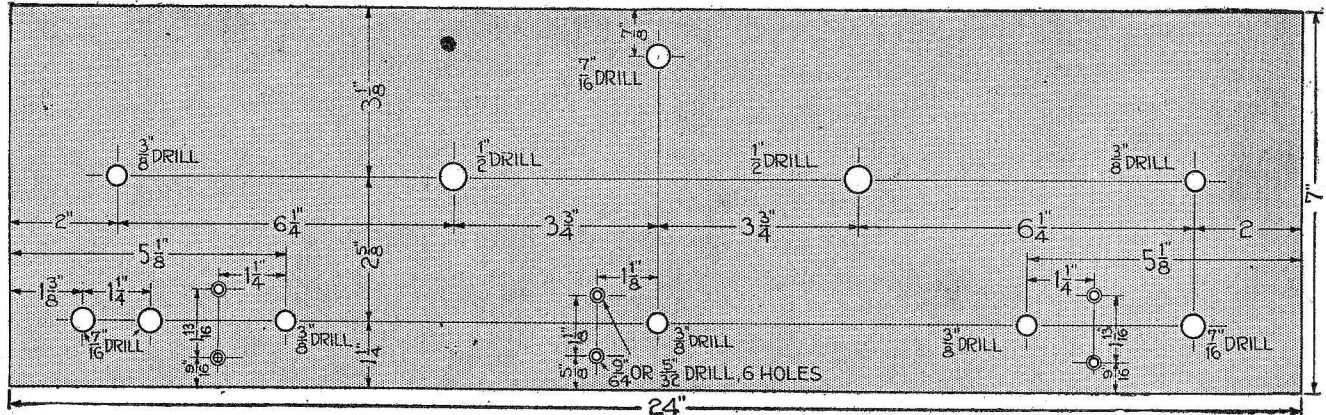

Figure 5

spring open circuit jack goes in the first hole to the left, while the second four spring jack, Carter number 104, goes in the other hole. A little to the right, and close to the bottom edge is a $\frac{3}{8}$ -inch hole for one of the 400-ohm potentiometers. A little further to the right the $\frac{3}{8}$ -inch hole is for the 10-ohm rheostat and further yet to the right we place the second 400-ohm potentiometer. The last hole to the right on this lower line is for the Cutler-Hammer switch which is to be mounted horizontally.

Assembling Front Panel

Since all of the instruments on the front panel are assembled with the single hole mounting feature, placing them on the panel is comparatively easy. The two pairs of holes just inside the potentiometer holes are, of course, for the Benjamin brackets, while the pair of holes to the left of the 10-ohm rheostat are for mounting two of the coils. The 25-turn coil is mounted on the upper hole, while

the double coil consisting of 25 turns and 45 turns is mounted on the lower hole so that it will be about $\frac{1}{4}$ inch from the former.

Figure 6 shows the layout for the sub base as to the apparatus mounting holes and, while the reader can possibly place the various instruments correctly from a study of figures 8 and 9, some suggestions will probably help. The tube sockets have been numbered in the illustrations in the order in which the signals pass through them, and will be referred

to in these articles by the numbers. Sockets 7 and 8 are at the left edge of the sub base and are mounted with the P and G terminals toward the front of the receiver. Sockets 2, 3, 4, and 5 are mounted along the rear edge toward the right and are to be placed with their P and G terminals toward the left. Socket 6 is in the front right corner to the right of the second Karas condenser and is placed with the P and G terminals toward the front. Socket 1 is that in the middle between (Continued on page 26)

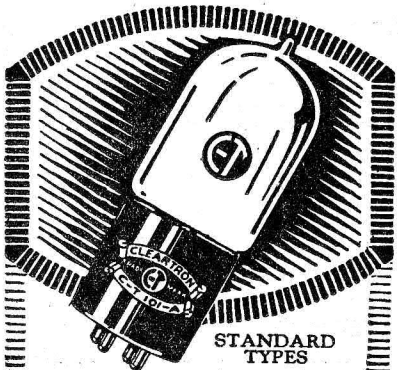

STANDARD TYPES \$2.50

CLEARTRON

GUARANTEED RADIO TUBES

Flawless reception—full enjoyment of radio is impossible without perfect tubes. Use Cleartrons and be sure of noiseless reception, more volume and long distance. Perfect service or instant replacement guaranteed.

At all reliable dealers

Write for free six page tube folder. CT-101A—A Hi-Mu tube for Resistance-Coupled Amplifiers \$3.00

CLEARTRON VACUUM TUBE CO. 28 West 44th Street New York City

Factories West New York, N. J., Birmingham, Eng.

FOR BETTER RECEPTION

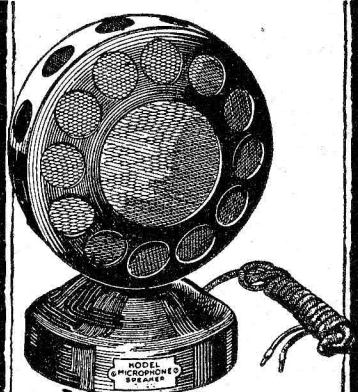

The **LOUD SPEAKER** that has the whole country talking

An exact replica in size and appearance of the microphone used in broadcasting.

Tremendous volume—loud—clear—every note as pure and rich as when it enters the broadcasting microphone in the studio.

Handsomely finished in Roman Gold. At any radio dealer

Two Models \$15 and \$20

The **KODEL MICROPHONE Loud Speaker**

Manufactured only by

The Kodel Radio Corporation

Owners of Broadcasting Station WKRC

509 East Pearl St., Cincinnati, O.

charges A or B Batteries 3 times as fast

NO longer is it necessary to wait several days for your battery to become fully charged. The new 5-ampere GOLD SEAL HOMCHARGER charges 150% faster than most other chargers - - - will fully charge the average battery OVERNIGHT!

It charges either A or B batteries - - is troubleproof, shock-proof, fire-proof, there are no bulbs to break, no acids to spill, no extras to buy. Any radio dealer can show you the new 5-ampere GOLD SEAL HOMCHARGER - - or can get it for you.

Manufactured Only By THE KODEL RADIO CORPORATION Owners of Broadcasting Station WKRC 509 EAST PEARL STREET CINCINNATI, OHIO

The New 5 Ampere **GOLD SEAL HOMCHARGER**

\$19.50

Free

Write for interesting 16-page booklet "The Secret of Distance and Volume in Radio" contains information for better radio operation.

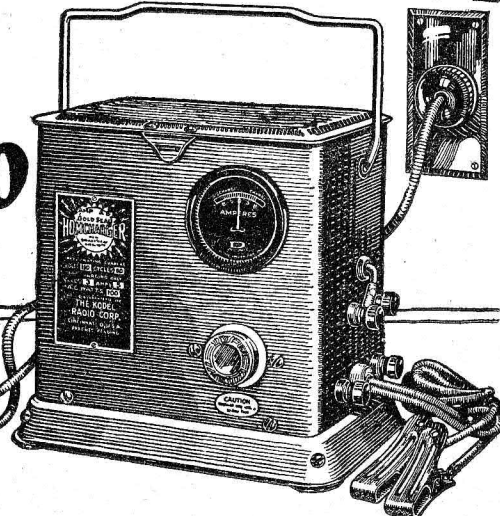

DEALERS: Watch for the KODEL double-page advertisements appearing every other week in LIBERTY MAGAZINE.

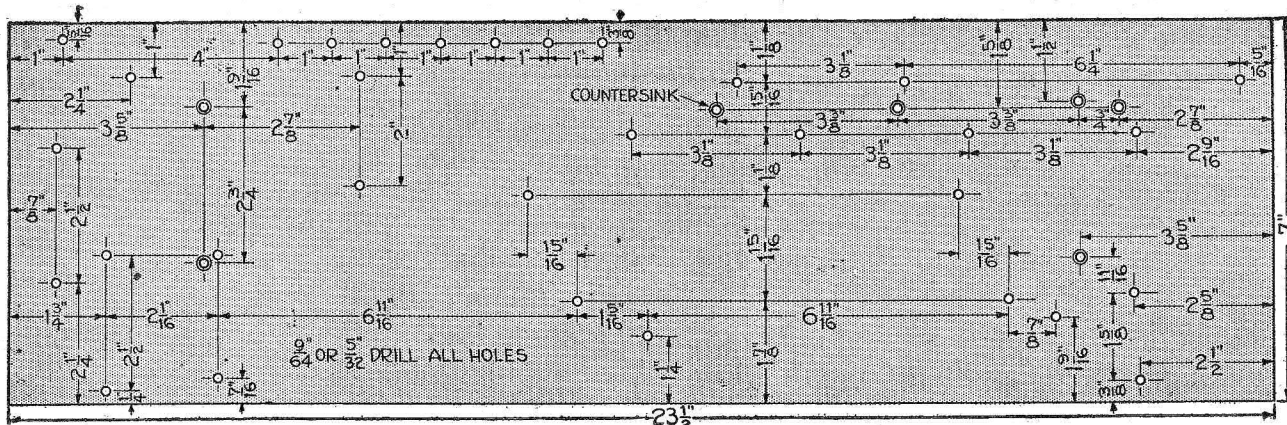

Figure 6

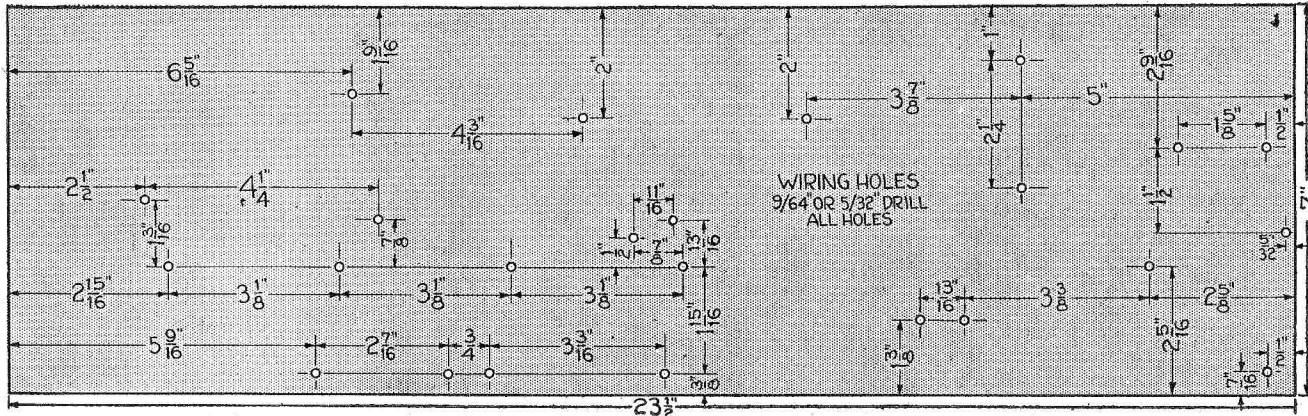

Figure 7

STRAIGHT-8 SUPER-HET

(Continued from page 25)

the two condensers and P and G are to the rear.

As the Victoreen intermediate transformers come to you, the small brass mounting brackets are bent at right angles. These will have to be bent down against the transformer so that they can be mounted beneath the sub base at a sharp angle as shown in figures 8 and 9. The writer found it a good idea to remove the small brass machine screw which secures the bracket at the edge of the coil. This will leave more room for the mounting nut which is placed on the machine screw that secures the transformer to the sub base. The 1/2-mfd. condenser is secured on the underside of the sub base by means of one of the mounting screws that hold socket 6. If the nut on this screw is turned up tightly, it will also hold the

condenser just as well as it could be done with two or three screws.

The mounting of the Amperites is perfectly clear from the photographs, and there is only one hole for a machine screw. This hole, as provided by the Radiall company, will not pass a 6-32 machine screw, and it will be necessary to ream or drill out the hole on each a little bit. A hole must be drilled in the lower strip of the left bracket for the mounting of one of the Meloformers and this hole is to be 4 1/8 inches back from the front surface of the flange by which this bracket is secured to the front panel. The coils should be mounted last as they are comparatively delicate and might be injured. When the other parts have been assembled, and when you come to them, the small 10-turn coil goes to the rear and the 52-turn coil is placed 1 1/2 inches in front of it. Their mounting arrangement and position can be clearly seen in the photographs.

The holes through which wiring must pass from the upper surface of the sub base to those parts mounted below, are shown in figure 7, and a separate template is provided for them so that there will be no confusion either in laying out the holes or drilling them. The reader can combine figures 6 and 7 into one template, but it will be better to make figure 6, punch the center marks and then drill these holes, and then duplicate this performance with figure 7. The 7 binding posts are placed in the seven holes directly behind the 10-turn antenna coil and in the following order. The antenna post is the first at the left and the ground post comes next. The third hole is for the plus A binding post, the fourth is for the negative A. The last three holes are for the negative B, the plus 45 B, and the plus 90 B, in that order.

(The wiring of "Straight-8" will be thoroughly explained in next week's issue. —Editor's Note.)

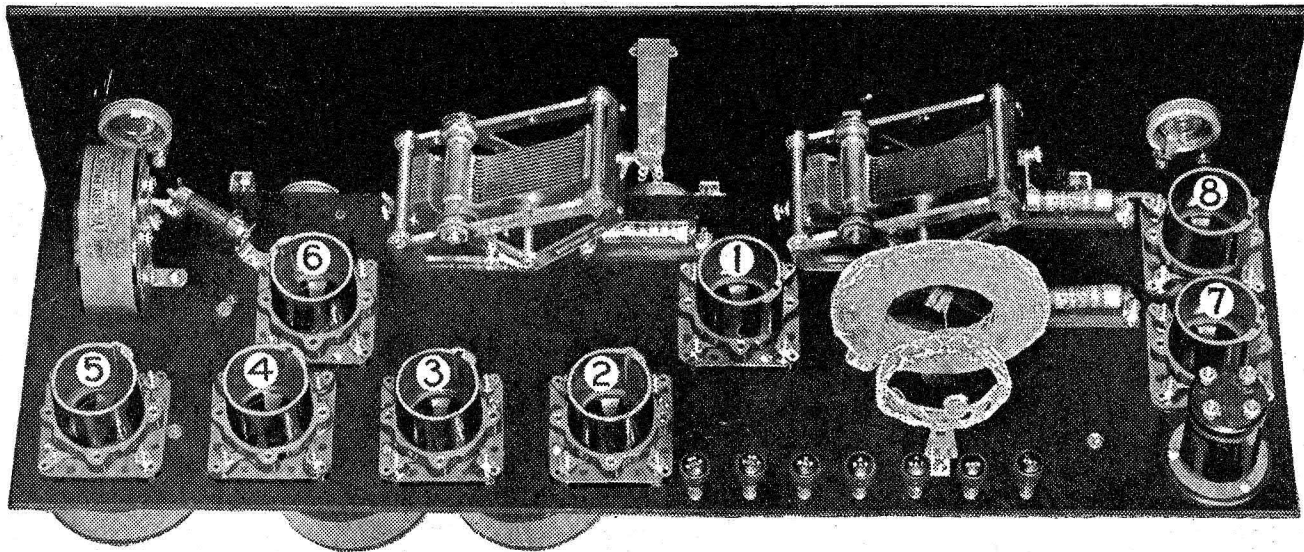

Figure 8

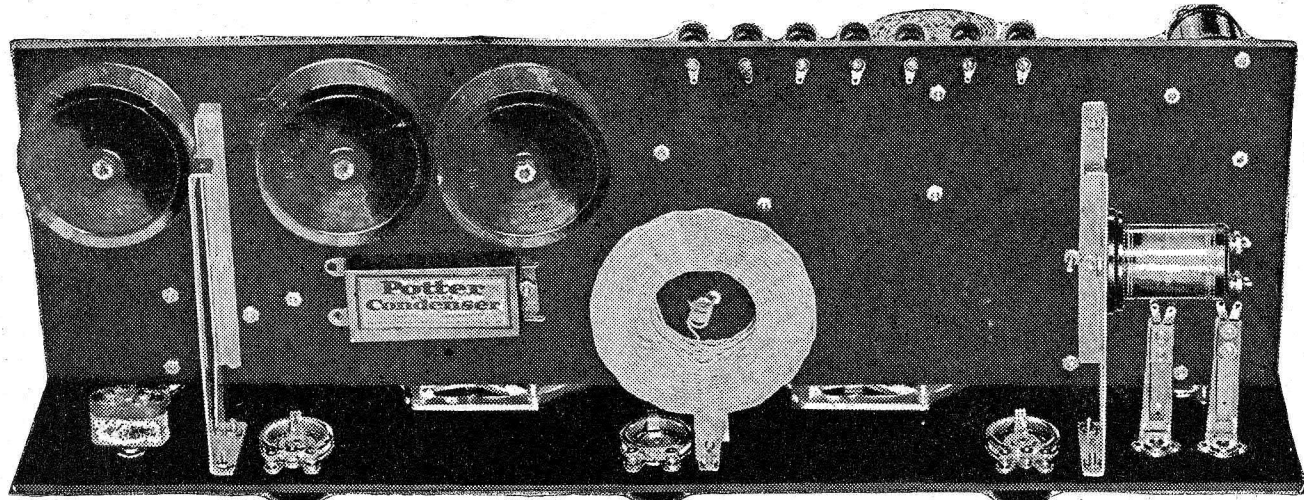
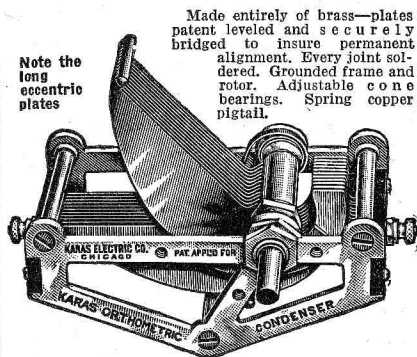

Figure 9

Recommended
by
Christen and Fournier
for their
"Straight 8" Super



But equally necessary for
all other hook-ups



Made entirely of brass—plates patent leveled and securely bridged to insure permanent alignment. Every joint soldered. Grounded frame and rotor. Adjustable cone bearings. Spring copper piston.

KARAS
Orthometric
Condensers

— the Condenser that inaugurated

Straight Frequency
Line Tuning

When we sprung the Karas Orthometric Condenser on a restless, hungry radio public—we knew we had started something. But we scarcely expected to be snowed under with such a literal avalanche of orders.

We inaugurated Straight Frequency Line Tuning at the psychological moment. Radio Fandom was waiting hungrily for something new. And here was something—not only new—but so perfectly simple—so thoroughly scientific—so downright sensible, that everyone wanted KARAS Orthometric Condensers at once.

Our scheduled production was like a drop in the bucket. Buyers pleaded—cajoled—even threatened. Our plans were doubled, trebled, quadrupled. But it all took time.

KARAS Orthometric Condensers could not be thrown together. It took months to train gangs to build them with the absolute precision KARAS demands. So tens of thousands had to wait or buy other makes, hurriedly assembled to supply the demand we had created.

NOW—after months of preparation we are able to produce enough KARAS Orthometric Condensers to take care of at least a fair share of the demand.

If your dealer hasn't secured a stock of Karas Condensers

Order on this Coupon!

Most good dealers everywhere, sell Karas Orthometric Condensers. If your dealer happens to be one who hasn't secured them, we will supply you direct on our 30-day Money-Back Guarantee. Just fill in and mail this coupon at once. Send no money. Pay your postman on delivery.

SIZES AND PRICES

- 23 plate, .0005 mfd.....\$7.00
- 17 plate, .00037 mfd..... 6.75
- 11 plate, .0025 mfd..... 6.50
- 5 plate, .0000972 mfd..... 6.50

Karas Electric Co.,
4034 N. Rockwell St., Chicago

Please send me.....Karas Orthometric Con-

densers, size.....at \$.....each. I will pay the postman the list price, plus postage, on delivery. It is understood that I have the privilege of returning these condensers any time within 30 days if they do not prove entirely satisfactory, and you will refund my money at once.

Name.....

Address.....

Dealer's Name.....
If you send cash with order, we'll send package postpaid

Applied A B C Principles of Radio Receivers

Part II—Your Duties as Train Dispatcher

By Carl Patterson

THIS season the majority of receivers are divided into the three classes: single circuit regenerative, 5-tube, and super-heterodyne. The chief difference between these receivers lies in their ability to separate stations and permit you to bring in to the unloading platform the train which you wish.

At the end of last week's article, it was stated that the 3-tube regenerative set provides only a limited switching equipment. Within the receiver there is a unit called a condenser, which operates in conjunction with a single layer coil of wire, and these two pieces of apparatus constitute a switching arrangement by which various trains can be brought in. If your terminal is provided with only one set of switches, as in this receiver, it is easy to handle the equipment but difficult to get the desired results. The 5-tube receiver includes three of these switching combinations and 2 tubes used as refueling stations.

Different Size Trains

Getting back to our comparison with a railroad, the effect of this switching arrangement as used is as though each train had a different width between the wheels, and you had a number of tracks with varying distances between the rails. It is up to you to manipulate the switches so that a train with a distance of, let us say, 5 feet between the wheels, gets on to the track in which the rails are 5 feet apart. A few minutes later it may be necessary to get a train with 4 feet 6 inches between the wheels onto the track with that distance between the rails. If your switches are set for the 5 foot width, any train which tries to come through having a different width between wheels will be derailed and does not get to the unloading platform, which is the detector.

The difficulty with the 3-tube receiver is that, due to the strength of local broadcasting stations, which may be comparable to the high speed of certain trains, they are enabled to jump over the switch and get to the detector where they unload at the same time with some other train. The 5-tube receiver in addition to provid-

ing refueling points, gives you three switches, and undesired incoming trains, if they jump the first one, will probably be wrecked by the second one, and surely by the third. Naturally, some manufacturers make their equipment more efficient than do others, and most of the cheaper outfits on the market are so inefficient as to switching apparatus, that unwanted trains get by even with three groups of switches.

It is your duty as the train dispatcher to carefully adjust the width of the rails at all three points so that they are exactly the same, and only the desired train can ride the rails. If this is done with sufficient care and the receiver is of a good make, even those stations whose wheel separations is very close to that of the desired train, will not get through and cause interference.

Known as "Wave Length"

The Radio comparison to this distance between wheels is called "wave length," and each station has a different wave length on which its programs are sent. The super-heterodyne provides only one group of switching apparatus but this is exceptionally efficient and usually functions better than three or four of the ordinary switches as contained in a set of the tuned radio frequency type. The super-heterodyne has one desirable feature in that there are only two dials necessary for the manipulation of its very complicated switches. It, of course, also provides amplifier tubes so arranged that they correspond to refueling trains which you can send out to strengthen those incoming trains which are very exhausted.

Part of your duties as train dispatcher includes the upkeep and care of the detector tube, the unloading platform, the amplifier tube refueling points, and the vacuum tubes provided to increase the volume of the programs after they are unloaded. All of these tubes are kept in operating condition by means of batteries, of which there are three types.

The first and most important kind is called the A battery which may be either the storage variety or consist of dry cells.

This battery is used to light the filaments of all tubes no matter what their use in the receiver, and this would correspond to repairs and replacements on our railroad system. The B battery supplies the difference in energy between that contained on the programs as they come in and that which is found at the loud speaker, to give the desired volume. The purpose of the B battery might well be compared to the salaries of the employees of the railroad. The C battery is found on most receivers, although there are a few which do not allow for their use, and the purpose of the C battery is to make all signals clear and distinct and also to cut down the amount of current drawn from the B units. The C battery corresponds to the efficiency manager and his department, on our railroad. Without the C battery there is likely to be too much current (salaries) drawn from the B units and the program, when unloaded, may be distorted.

Care of Batteries

The repairs and replacements are taken care of by frequent testing and recharging of the storage battery or occasional replacement of the dry cells. The care of the storage battery is fully explained in another article in this issue of Radio Digest. B batteries usually require but very little attention and perform their duties most efficiently. It will be necessary to replace the efficiency manager or C battery only about once every four months. The amount of energy drawn by the filaments of the tubes from the storage A battery or dry cell A battery, is controlled on the front of the panel by small knobs attached to pieces of apparatus which the Radio man calls rheostats. Turned in one direction they permit the tube to draw out more current, while turned in the other the available amount of energy is cut down. A certain point is usually found in the matter of rheostat adjustment from which the tubes draw

out sufficient current, but not too much from the standpoint of economy.

Antenna Important

Little has been said up to this point about antennas, of which every receiver needs one, nor about a connection with the ground. These two adjuncts have no similar equipment on the railroad. A receiving antenna or, as it is also called, an aerial, consists of a single wire either outside the building or within it, which serves to collect the various programs (trains) flying through the air and guide them to the receiver. The ground connection does this also, except that it collects that portion of the Radio energy from a broadcaster which travels in the ground.

All the 3-tube receivers available, and most of the 5-tube sets known as tuned radio frequency, require such an antenna and ground connection. There is no question but that a wire from 50 to 100 feet long, strung outside, about forty feet high if above a house and 10 feet above the roof if over an apartment building, is vastly superior to any arrangement of wire inside. A length of wire can be strung around the picture moulding in one or two rooms or it can be stretched in the attic, but it cannot give the range possible from the same length of wire hung outside. An inside antenna such as mentioned has only one point in its favor. In hot months it will not pick up quite as much static or atmospheric interference as will the outside wire—neither, however, will it pick up as much Radio station energy. At best it can only be called a makeshift to be used where the erection of an outside antenna is impossible.

Get a Good Ground

The ground connection is obtained by securing a wire to some large piece of metal that has broad surface in contact with the earth. Most Radio set owners

(Continued on page 28)

Hello Europe!

You can be prepared to tune in European Stations during International Test Week if you have a

VICTOREEN SUPER-HETERODYNE

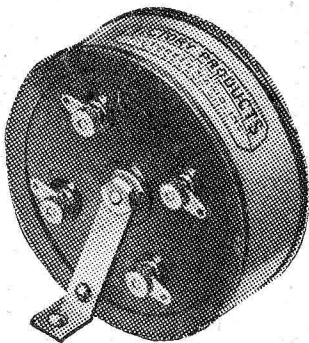

Many radio fans who had built Victoreen Super-Heterodyne sets last year were able to hear French and English stations during the test period.

Build your Victoreen set now

4—No. 170 R.F. TRANSFORMERS at \$7.00 each and

1—No. 150 Oscillator Coil at \$5.50.

Constitute the Heart of the Circuit.

No oscillations, howls or squeals—no matching of tubes.

Victoreen No. 170 R.F. Transformer—neat and compact—3" in diameter, 1" thick. Complete parts to build the "Victoreen" can be purchased of your dealers for between \$50.00 or \$75.00—depending on quality of material selected.

Ask your dealer for free "Victoreen" folder which contains hookup and complete information, or write us direct.

Your dealer is prepared to furnish you with all parts necessary.

The George W. Walker Co.

6505 Carnegie Ave.

Cleveland, Ohio

Branch Offices in Principal Cities

Trans-Atlantic Reception

The Crosley "Pup" is an improvement over the Crosley 1-tube sets on which over a hundred instances of Trans-Atlantic reception have been reported. Yet it sells for only

\$9.75 (Add 10 per cent west of the Rockies)

THE CROSLEY RADIO CORPORATION, Cincinnati, Ohio

CROSLEY RADIO

BETTER · COSTS LESS

Christmas Suggestion

WHAT could be more appropriate than an annual subscription to Radio Digest? The publication is built as a necessity to all Radio set owners. Your Radio friends will appreciate such a gift.

Fifty-two reminders throughout the year! Fill out the coupon and we will advise the subscriber that it is a Christmas gift from you. This gift subscription includes the new book, "Radio Receivers."

Five Dollars enclosed
Subscription goes to

Name

Address

City State.....

Name of Donor.....

Mail to Radio Digest, 510 North Dearborn Street, Chicago, Illinois

Canary Shares Place Of Honor with Organ

Bird at WOC Breaks Into Program Unannounced

DAVENPORT, IA.—Dr. B. J. Palmer's pipe organ, frequently heard in organ recitals broadcast from WOC in this city, usually has a rival for the place of honor on the broadcast programs. That rival is no other than a little canary. Many of WOC's listeners have commented on the little feathered fellow's determined efforts to make himself heard. Day or night, no sooner does the organ start playing than the canary starts up his song, and although his cage is located at a considerable distance from the microphones, his notes can be very plainly heard through the ether. Although never announced the canary is a frequent artist at the Chiropractic station at Davenport.

WAAM Brings Christmas Cheer to Crippled Kiddies

NEWARK, N. J.—So that the inmates of the Home for Crippled Children, in this city, might enjoy a more cheerful Christmas, Station WAAM broadcast a special feature Thursday afternoon, December 17, to swell the Christmas fund of the institution. Written requests for numbers accompanied by donations to the fund were broadcast during the afternoon, and fans from every section of the country and Canada helped to bring joy to the unfortunate kiddies.

The following artists appeared on the program and gave request numbers exclusively: Ray Nichols Recording orchestra, Hilda White Kay, John A. Scott, Arthur Johnston and the Hartley Joy Boys.

University of Cincinnati Is Now Broadcasting Lectures

CINCINNATI.—Following the custom of the past two years, WSAI is broadcasting a series of lectures by faculty members of the University of Cincinnati. President Frederick C. Hicks recently inaugurated the new series which can be heard every Wednesday night at 10 o'clock, central time, when some member of the faculty gives a five-minute discussion on various phases of science, art or literature.

DIRECTIONS FOR REQUESTING INFORMATION

The Questions and Answers department offers service to Radio Digest subscribers without charge and, to those not subscribers, the same service with a charge of 50c for each letter requiring up to three answers or diagrams. We feel that this policy is necessary for the protection and best interests of our regular readers, as the volume of correspondence to this department has increased to such an extent that it is almost impossible to give our subscribers' letters adequate attention nor a complete answer. To those who have long been newsstand readers this may, at first, seem an injustice but a little thought on the matter will show that this is the only possible solution of what has been, to the technical department, a very perplexing and difficult problem. We ask that the following suggestions be read carefully before writing:

1—Search carefully the back issues which you have, as the point in question has probably been covered several times before.

2—The book, "Radio Receivers," given free with each yearly subscription (when received by Radio Digest direct with full remittance of \$5), contains the answers to the majority of the questions asked. If you have this book, go through it thoroughly and it is probable that you will find the solution of your problem.

3—Letters for this department should be kept separate from all correspondence to other departments and on other subjects.

4—Questions should be written on one side of paper only and each sheet should bear the sender's name and address. All letters should be accompanied by a self-addressed stamped envelope of standard business size.

5—Unsigned (or anonymous) letters cannot be answered, either in

Radio Digest or by letter, nor can those without address.

6—No comparative statements on advertised apparatus will be given except as to efficiency in some particular circuit.

7—Drawing diagrams on a separate sheet of paper will save time and enable us to give all questions more attention.

8—Write each question as a separate paragraph.

9—Keep a copy of your letter and diagrams, to which we can refer without re-drawing.

10—The names and addresses of the writers of letters published will not be released except with the writer's permission.

11—We want to be of assistance to you in your difficulties, but are sometimes limited because of the length and time required for the proper consideration of the questions asked. Therefore, please make your letters brief.

Atwater Kent Hour in Canada

MONTREAL.—The first of a series of Canadian Atwater Kent hour was given recently by Station CKAC, La Presse, Montreal. Arrangements have been made between the Atwater Kent company and the Canadian superpower station to broadcast a number of concerts by famous artists booked by the Radio firm. Artists appearing on this special series travel from New York to Montreal to broadcast the programs.

Are Now WLIB Artists

The Langdon brothers, Hawaiian guitar specialists, well liked by Chicago listeners, have become exclusive WGN and WLIB artists. They are heard usually on Friday evenings between 10 and 11 p. m., central time, from WGN, and during Fred Hamm's Sunday afternoon jazz concert over WLIB.

APPLIED RADIO A-B-C'S

(Continued from page 27)

get this by firmly clamping or soldering a wire to a cold water pipe which provides miles of surface in contact with the earth. Farm users must devise some other method and this usually results in their driving a long rod about four feet into the ground, preferably where it is damp, and attaching the wire from the set to this rod. A still better idea, however, is to bury all the large pieces of metal available with a wire connecting them all. The thin copper shims used on cars between the cylinder block and the cylinder head are excellent for this purpose and garages are usually very glad to have someone drag them away. Old copper wash boilers, ice box linings, chicken wire, rain gutters, etc., are used.

The super-heterodyne, in 95% of installations, does not require either outside wire, inside wire or ground connection. Its pick up means takes the form of a square framework about two feet on a side, wound with 85 to 100 feet of flexible insulated wire. The ends of this wire are lead directly to a condenser within the set and this type of antenna, which is called a loop aerial, forms, with the condenser, a switching arrangement. It takes the place of a coil which would, ordinarily, form the wire part of our switch. The super can be altered to operate on an outside wire and ground connection if one desires to do this.

(Connecting the accessories and the operation of receivers will be the subject of the next article of this series by Mr. Patterson.—Editor's Note.)

South Dakota Woman Logs

345 Stations in Two Years

DX champions throughout the country may well look to their laurels. A strong contender for long distance honors entered the field when Mrs. Marie Quickstad of Toronto, South Dakota, sent an official affidavit to the Radio Digest to the effect that in the past two years she has tuned in and logged 345 Radio stations. In her log are included stations in Cuba and Porto Rico. As there are only four stations in her state, Mrs. Quickstad has become accustomed to reaching out and bringing in distant stations.

When using battery chargers it is absolutely necessary to connect the positive terminal of the charger to the positive terminal of the battery.

Building a Super?

Ryan's Simplest Possible Super-het Manual

50¢

Full Size Drilling Templates— Loop Aerial Construction

ANYONE who has built a crystal set or single-tube can follow Mr. Ryan's concise, simply worded instructions and enjoy the range available only from a super-heterodyne. Every wire, every lug, is placed by his directions and you cannot go wrong.

The construction of loop aerials, storage "B" batteries, a charger and even the cabinet are gone into thoroughly. This manual covers the complete installation of a selective, quiet, long range Radio outfit. Send money order, stamps or currency to

Radio Digest Publications
510 N. Dearborn St., Chicago

Used by John G. Ryan in the "Simplest Possible" Super

ONLY
\$22⁵⁰
BY MAIL



Qualitone Super Kit

USING the Qualitone Kit in the Simplest Possible Super-heterodyne described in Radio Digest, makes unnecessary any changes in the diagram and insures perfect operation on completion of the wiring. Each part fits into place as shown in Mr. Ryan's layouts.

Kit includes three long wave transformers, one filter coupler and one oscillator coupler, with complete set of blueprint instructions, all packed in sturdy SEALED carton. Genuine Bakelite and silk covered wire employed throughout.

Mail orders filled promptly on receipt of check or money order.

Can be used in 7 or 8 tube supers and the Heteroflex described in Radio Digest of August 1st.

QUALITONE RADIO CORP.
4600 LINCOLN AVE. CHICAGO, ILL.

Code Practice Buzzer Easily Made

Experimenter Can Wind Magnets Very Cheaply

If you have a small transformer, a very good buzzer can be made at very small cost for practicing the code. First get two spools and wind twenty-two turns, then put some tape on and then,

WORKSHOP KINKS EARN A DOLLAR—

THERE are many little kinks worked out at home that would aid your fellow Radio worker if only he knew about them. There are new hook-ups, new ways of making parts and various unique ways of operating sets that are discovered every day. Radio Digest is very much interested in obtaining such material. Send them in with full details, including stamped envelope, so rejected copy may be returned. The work must be entirely original, not copied.

RADIO KINKS DEPARTMENT
Radio Digest
510 North Dearborn St., Chicago

without breaking the wire, wind on twenty-two more turns. Use number 23 d.c.c. wire. Then force stove bolts through the spools and clamp them to a small panel provided with a baseboard. Then cut a piece of tin and bend at right angles so it can be fastened to the baseboard and set just in front of the spool cores. The illustrations show how these parts go together. When adjusting for operation do not let the tin quite touch the bottom core but keep it about 1/8 inch from it.—Harry Freeman, Mitchell, S. D.

Homemade Cablelug

Take a burned out or broken WD-11 type tube and remove all the glass part. This may be done by heating the solder tips of the pins and pulling the glass from the base. Now solder the terminals

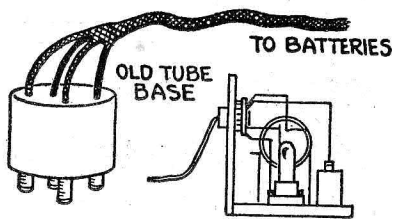

of a four-wire cable to the contacts within the tube base and fill with sealing wax. A hole may be bored through the panel and a WD-11 type socket used for the wire terminals within the set.—G. E. Norton, Oklahoma City, Okla.

Salvaging Pfanstock Clips

Most Radio fans have worn out B batteries lying around. One can make good use of the clips on them by breaking out the clips and boring a hole big enough for a binding post or machine screw close to the end of the clip where it is broken from the battery. There are many uses for the clips after they have been fixed this way. The experimenter who makes set-ups of apparatus and then makes changes can put the clips on condensers, rheostats transformers, etc., and then does not have to melt solder at the connections.—Allan Waldron, Oregon, City, Ore.

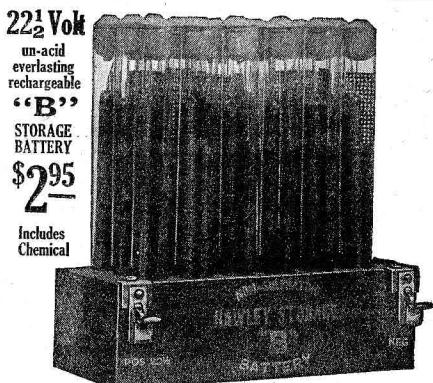

45 volts, \$5.25; 90 volts, \$10.00; 112 1/2 volts, \$12.50; 135 volts, \$14.75; 157 1/2 volts, \$16.80. Truly the biggest buy today. Easily charged on any current including 32-volt systems. Any special detector plate voltage had. Tested and approved by leading authorities such as Popular Radio laboratories. Over 3 years sold on a non-refundable 30-day trial offer with complete refund if not thoroughly satisfied. Further guaranteed 2 years. Knock-down kits at great savings. Complete "Hawley" "B" battery charger, \$2.75. Sample cell, 35c. Order direct—send no money—simply pay the expressman cost on delivery. Or write for my free literature, testimonials and guarantee. Same Day shipments. B. Hawley Smith, 317 Washington Ave., Danbury, Conn.

DETAILS OF BUZZER CONSTRUCTION

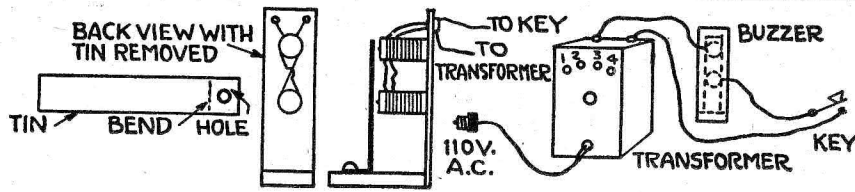

Switch Permits Wide Wave Range

Many single circuit receivers will not tune to the very high waves. If you wish to receive stations on these waves, here is a simple way to do it. Obtain one of the small double-pole, double-throw

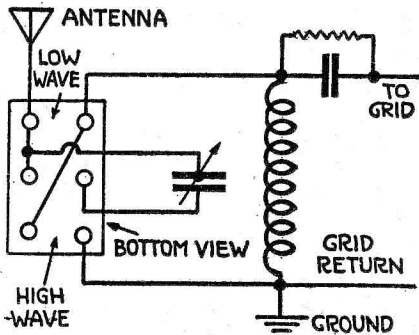

switches on a bakelite or hard rubber base (or a DPDT jack switch) and wire according to the attached diagram. The switch may be mounted anywhere convenient about the Radio or on the panel or sub-panel.—Allan Murphy, Paducah, Ky.

Fixed Condenser Terminals

This is a good wrinkle for the fan who is always building up and tearing down new hook-ups. Switch contact points have a threaded portion and nuts and make good binding posts by slipping the

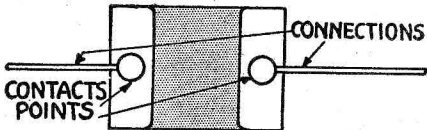

threaded portion through the holes in the fixed condenser. Connecting wires can be slipped under the nut or the head of the contact point and, when an assembly is being torn down, it is not necessary to unsolder a lot of leads.—Omer D. Evans, Hazelton, W. Va.

EKKO BROADCASTING STATION STAMP ALBUM

Official Stamp at Over 400 Stations

A permanent, authentic means of recording all stations you hear. Squares for more than 650 stations. Proof of Reception cards furnished with album. Send card to station, proving you heard it, with 10c to cover cost of verification. They send you beautiful engraved verified stamp showing call letters. Almost all, over 400 stations, distribute Ekko stamps. Album is 9 1/2 x 11 inches, handsomely bound in two-color board cover, 96 pages. Start your collection now. Sent postpaid on receipt of price.

MONEY BACK IF NOT SATISFIED Price \$1.75

THE EKKO COMPANY
940 Harris Trust Building CHICAGO

Driving Ground Rods

I am attaching a sketch of the method I use in putting in ground rods in the winter time. When using a regular telephone ground rod for a ground, take three pieces of half-inch gas pipe in two-foot

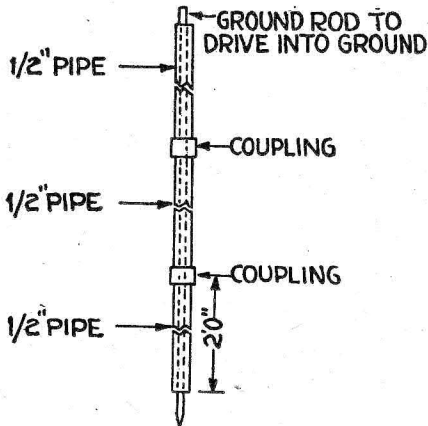

lengths, thread both ends, and place the ground rod inside. As the rod is driven into the ground, uncouple the pipe. This arrangement holds the pipe steady for driving and prevents it from bending.—R. H. Rauh, Luton, Iowa.

Letters received from fans all over Great Britain show that London programs are preferred to those of any other British station. Country fans are unanimously of the opinion that 2LO is better than their local stations.

The MOLLIFORMER "B" UNIT REPLACES "B" BATTERIES

BUILD IT YOURSELF

You can build the marvelous unit easily in an hour and have a "B" eliminator that gives perfect reception on Locals or DX stations. Model FW4 designed especially for 5 or 6 tube sets has low internal resistance. Full wave rectifier and perfect filtering action take out all AC Hum. Capacity 90-120 volts. If your dealer cannot supply you order direct. Descriptive literature and wiring diagram sent upon request.

Price per Kit of all Parts— \$17.00
60 cycle
25, 40 or 50 cycle 19.00

Kits include full wave rectifiers.
DEALERS—The Molliformer will make friends for you. Send for demonstrator today.

C. E. JACOBS, Sole Mnfr.
2802 N. Kedzie Ave. CHICAGO

Christmas Suggestion

YOUR immediate action will give an ideal Christmas present. Your Radio friends will surely appreciate a gift of an annual subscription to Radio Digest. You can be the kindly remembered donor of such a gift. The reminder will come each week during the year. Fill out the coupon and mail with your remittance. We will advise the subscriber that the subscription is being sent them as a present from you. The gift subscription includes the new book, "Radio Receivers."

Five Dollars enclosed
Subscription goes to

Name

Address

City State.....

Name of Donor.....

Mail to Radio Digest, 510 North Dearborn Street, Chicago, Illinois

Filament Circuit Tester

No doubt many a fan has had the experience of blowing a tube from a short circuit in the filament leads with those of the B circuit. This device prevents that. Take the base of an old tube and

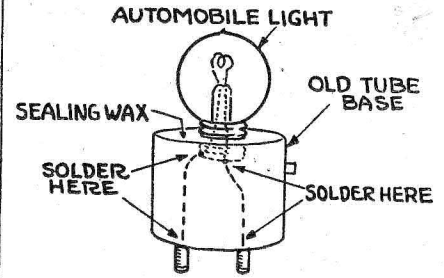

solder leads from a small auto light to the filament pins of the tube base. Then force the light down into the base, making sure that the wires do not short and pour melted wax in around the base of the lamp to hold it in place.—Edward Ford, Birmingham, Ala.

ELIMINATE! STATIC!

Enjoy perfect reception regardless of weather conditions. The Static Eliminator—the newest and most startling thing in Radio—cuts out practically all static without loss of volume! And in addition it will help increase selectivity, tune out local stations, sharpen signals, remove noises, lessen interference and prevent re-radiation!

Use it with any receiving set—simply hook up to your aerial lead-in and enjoy perfect reception unmarred by static.

100 Postpaid
STATIC ELIMINATOR COMPANY
610 United Bank Bldg. Cincinnati

\$39.95

The Biggest Value in Radio

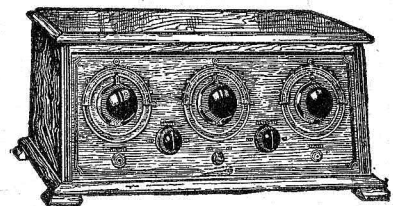

D-X-RANGER

The D-X Ranger is a remarkable 5-tube Tuned Radio Frequency, Long Distance, Selective Set that brings stations in clearly. The cabinet is gracefully designed, made of hand-polished walnut and is decorative in the extreme. All parts have been selected by thoroughly schooled Radio experts and constructed by skilled Radio engineers. The D-X Ranger is

GUARANTEED

to be absolutely perfect. Our gigantic output of the D-X Ranger 5-tube Tuned Radio Frequency makes possible the sensationally low price. Mail your order at once and begin to enjoy Real Radio Reception.

\$39.95

WARD & CLARK
3335 North Clark St. Chicago

The Reader's View

Cheating Themselves

I have been very much interested in your comments on the attitude of the announcers of some broadcasting stations. I think, by continuing along the lines that you have started, no doubt, some good must develop.

My experience has been the same as many of your subscribers. I have logged over 235 different stations and last night I made a record for my set. I tuned in for a period of over two hours and heard one station announced, that was WBOQ, Richmond Hill, N. Y. There was a very good program by some station around 260 meters that I would say I listened to for at least three-quarters of an hour. The program was an excellent one on which anybody who heard it could not help complimenting the station if they knew who to compliment. A week ago I listened to one of your Chicago stations at about 11 o'clock for over one solid hour with the hopes that I would hear the name of the station announced. The reception in both of these instances was very clear but in neither case was I rewarded for my patience.

At some of the stations which do announce at, I would say, about 2-4 time so that you can get everything clearly, when it comes to announcing the name of the station, the announcer immediately jumps to 8-10 time. There is only one conclusion I can draw and this is the station is on the air for the entertainment of those only who are in the studio or who know what to expect.—T. P. D., Hartford, Conn.

He Has to Criticize; He's Our Critic

We are sure a good many readers of Radio Digest would enjoy your column if you desisted from adverse criticism of certain stations, or at least had the courtesy to omit the call letters in writing of broadcasters who personally disatisfy your tastes.

We are speaking now, in particular, of your naively phrased criticism of WSMB, in the November 21 number.

If your set can stand the strain, we would suggest that you tune in on WSMB and notice if any musical numbers are repeated for telegraphic requests. They are not. The announcer only reluctantly started reading a few telegrams over the "mike" after insistent requests of thousands of listeners—and then only on dance nights.

Having only logged 174 stations so far, I am really no authority on the idiosyncrasies of broadcasters and my opinion that WSMB is above the average cannot compare, of course, with your superior judgment.

It would be easier on the eyes, though, to keep the columns of Radio Digest free from warped personal opinions.—W. A., Covington, La.

After Every Number

I noticed last night a number of station announcers still neglect to give their call letters between each number. The worst of these offenders were WMAK of Lockport, WBAP, Fort Worth, and WJR, Detroit.

I would suggest that you try, through the editorial columns of your paper, to get the different station announcers to at least announce their call letters after each number. Some of these stations last night played as many as eight numbers without making any announcement as to their station.—R. M. K., Chicago.

Attention Announcers

Why do so many of you announcers withhold your call letters and location? How long does it take to pronounce three or four letters and the name of the city? Give us at least the call letters before each programmed number and we can find the location.

Don't forget that there are new Radio owners making up their logs, dealers

CLASSIFIED ADVERTISEMENTS

RADIO

Long Distance Radio \$2.95. Lambert's newest crystal success. No tubes. No batteries. No grief. Always ready. Works 600 miles. Fully guaranteed. We pay postage. Order direct from this ad. Leon Lambert, Wichita, Kansas.

SALESMEN WANTED

Make \$100 WEEKLY in spare time. Sell what the public wants—long distance radio receiving sets. Two sales weekly pays \$100 profit. No big investment, no canvassing. Sharpe of Colorado made \$955 in one month. Representatives wanted at once. This plan is sweeping the country—write today before your county is gone. OZARKA, INC., 126-G, Austin Ave., Chicago.

Sell Five Tube Radio Sets. Thirty days' free trial. Three sales weekly pay \$90 profit. No experience necessary. Direct, 197 Fourteenth St., Milwaukee, Wis.

demonstrating to prospective buyers and other reasons why you should identify your station.

We certainly appreciate the splendid programs rendered and other efforts of the broadcasters.—A. C. R., Cambridge City, Ind.

Attention, Pacific Coast!

There seems to be some difficulty among the California stations in trying to get their favorable decision to close down one hour each night during International Radio week, when the fans of the country are to listen in for foreign station programs. Now there should be no difficulty in convincing Californians that their stations should get off the air for the seven hours of the tests. Here are a few reasons:

1. California, if it does not sign off, will be heard all over the U. S. Any three or four tube set (and larger sets, of course), can get California under such conditions—just when the listener doesn't want the "sun-kissed" state.

2. If the California station owners desire to serve the interests of the largest majority of listeners, it would do well for them to concentrate their minds on the fact that not one-tenth, indeed, not one-twentieth of the American invisible audience lives on the entire Pacific slope, or is out of range of European reception.

3. If only a few Pacific coast stations decide to disregard the international tests and keep on broadcasting, in order to serve perhaps their miserably small quota of the listening audience, they will be ruining the small chances of five millions of fans living in all parts of the United States and Canada, for hearing any of the European stations.

4. Whether or not the Pacific coast fans' sets are capable of European or Asiatic reception, the Pacific fans want to try. I know this for sure, for I am one, and I have asked many of my Radio friends, all of whom are of the same opinion. I know of a number of sets as small as two tubes located here on the Pacific coast which heard Europe last year, that is, when the coast stations shut down. My four tube dry cell set picked up two.

The above four reasons seem to be enough. Why go further? If any coast station stays on the air during the test hours, it is going to be labeled "AIR HOG" by 95 per cent of the United States and Canadian Radio public.

I suggest as fit retaliation that disgruntled Radio fans, of which there are sure to be several millions, quit eating grape fruits, oranges, raisins, prunes and stop using anything coming from California. That's a harsh order coming from a native Californian, but it is one way of bringing the question to an issue. Eat Florida oranges and citrus foods. Go to Florida instead of California for your

vacation. And let California broadcast all it pleases, if it has any money with which to do so.—R. A. M. San Francisco, Calif.

ADVANCE PROGRAMS

(Continued from page 21)

Friday, January 1

WOAI, San Antonio, Tex. (394.5), 3 p. m., musical program, Kamma's Hawaiians; 8:30, Hotel Menger trio.

WOAW, Omaha, Nebr. (826), 12:45 p. m., Sunshine Sunday dinner menu, recipe service; 1, Randall's Royal Fentelle orchestra; 6, music review; 6:50, Jaffy's string quintet; 9, classical program; 10:30, Frank Hodek and his Nightingale orchestra.

WOC, Davenport, Iowa (483.6), 4-5 p. m., Crescent orchestra; 8-9, musical program, artists, F. E. Kellogg, director; 9-10, special program, Palmer Little symphony orchestra, Erwin Swindell, conductor; W. L. Mueller, baritone; Selma Hickey, violinist; John Gerwe, tenor; Walter Voss, bass; E. J. Bettendorf, pianist; B. J. Palmer, organist; talks.

WOI, Ames, Iowa (270), 12:30 p. m., college chimes; 12:45, "Agricultural Economics"; Prof. C. L. Holmes. WOK, Chicago, Ill. (217.3), 5-7 p. m., Capitol theater organ; Jean Carlson, soprano; Bob Mokrejs, pianist; George Allen, tenor; 10-1:30, Bernie Cummins Town club orchestra; Husk O'Hare's Coconut Grove orchestra; Capitol theater program; Arnold B. Stephenson, musical saw soloist; Harriet Lee, contralto; Herman Sinalko, violinist; George Allen, tenor; Bob Mokrejs, pianist.

WORD, Batavia, Ill. (275), 7 p. m., Webster hotel concert trio; 7-15, musical program; 7:30, Uncle Dan Radio study club; 9, musical program, Lillian Read, director.

WSB, Atlanta, Ga. (428.3), 8 p. m., concert; 10:45, Carter Electric Radiola orchestra.

WSOE, Milwaukee, Wis. (240), 1-8 p. m., special open air New Year's day program; chimes; 9, special studio program, community singing, S. J. McKillop, director.

Mountain Time Stations

KFWA, Ogden, Utah (261), 4-5 p. m., organ recital; 5-6, Ogden Radio dealers program.

KOA, Denver, Colo. (322.4), 12:15 p. m., Rialto theater musicale; 3:15, exercises; 3:30, matinee for housewives; 4, culinary hints; 4:15, fashion hints; 6:30, Brown Palace string orchestra; 7:30, preview of international Sunday school lesson; 3, minstrel show, KOA minstrel players; KOA orchestra; Blue Bell quartet.

KQB, State College, N. M. (348.6), 7:30 p. m., special musical program.

Pacific Time Stations

KFOA, Seattle, Wash. (453.3), 6:45-8:15 p. m., Sherman, Clay and company, studio program; 8:30-10, Times studio program; 10-11:30, Eddie Harkness and his orchestra.

KFON, Long Beach, Calif. (282.4), 4:30-5 p. m., amusement bulletin; 6-6:30, organ recital, Brayton's theater; 6:30-7, Captain's Inn dance orchestra; 8-9, Press-Telegram program; 11-1 a. m., Long Beach Elks No. 388, midnight frolic.

KFWB, Hollywood, Calif. (252), 7:10 p. m., talk on safety or sorrow, Serat. Edgar Johnson of L. A. P. D.; 7:20, Jack Boaz, fishing and hunting scout; 7:30, eye-ologue, Dr. Marshutz; 7:40, microphone brev-

ties; 8-9, program, John Wright, The Right Tailor; 10-11, Warner Brothers frolic, direction Charlie Wellman; 11-12, Hollywood Roof ballroom orchestra by remote control.

KGO, Oakland, Calif. (361), 11:30-1 p. m., luncheon concert; 3-4, George Kruger, pianist; Myrtle Gable, Tina Pucinelli; violin numbers, courtesy Nathan J. Landsberger; "Magazine Article Digest," Library Service bureau; vocal numbers, Artilaga Musical college; 4-5:30, concert orchestra, Hotel St. Francis; 6-7, Norman Woodside's Metropolitan orchestra.

KGW, Portland, Ore. (481.5), 12:30-1:30 p. m., Rose City trio; 6-7, dinner concert; 8-9, concert; 9-10:30 p. m., concert, Sherman, Clay and company studio; 10:30-12, Hoot Owls.

KHJ, Los Angeles, Calif. (405.2), 6:30-7:30 p. m., history story, Prof. Herzog and New Year's party for the KHJ Radio kiddies; 8-10, program, Western Auto Supply company; 10-12, Don Clark's Biltmore hotel dance orchestra.

KMTR, Hollywood, Calif. (238), 5-6 p. m., Peter Pan hour with Mammy Simmons, Marion Gilmore, Magdalene Schaffer and pupils, Adelaide Gosnell Lee; 7, "Color Photography," Chas. W. Beam; 7:30, "Wonders of Nature," Prof. Alfred Cookman; 8-10, The Turner orchestra, Loren Powell, director; 10:11, Starr Piano company studio.

KNK, Hollywood, Calif. (336.9), 7-7:30 p. m., El Patio ballroom orchestra; 7:30-8, program, Eastern Outfitting company; 8-9, West Coast theaters; 9-10, Optimistic Order of Donuts; 10-11, program, Walter G. Scheek; 11-12, Ray West's Coconut Grove dance orchestra from Ambassador hotel.

KPO, San Francisco, Calif. (428.3), 7, 7:30, 8 a. m., daily dozen exercises; 12:45, talk; 1:30-2 p. m., Rudy Seiger's Fairmont hotel orchestra; 5:30-6, special program for children; 6:30-7, Waldemar Lind and the States Restaurant orchestra; 7-7:10, investment talks; 8-11, Palace hotel dance orchestra, Gene James, director; Maurice Ginsky, tenor; Merton Borjes, pianist; Al Jacobs, pianist.

KTAB, Oakland, Calif. (240), 9-9:30 a. m., prayer service, Rev. E. L. Spaulding; 8-10, program, Breuner's.

HEATH CONDENSERS

For Real Radio Reception

Write for Literature

HEATH RADIO & ELECTRIC MFG. CO.
206 First St., Newark, N. J.

\$1.50 for Your Old Radio Tubes

regardless make or condition, toward purchase of each new standard \$2.50 tube. Positively guaranteed. We do not sell re-built or bootleg tubes. Agents Wanted.

Super-Service Laboratories, Dept. M, Room 58, 39 West Adams, Chicago, Ill.

CARTER
Year after year the sale of Carter radio products increases. Insist on genuine Carter products, for the "just as good"—and "just the same"—may not be here tomorrow. As Lincoln said, "you can't fool all of the people all of the time."
Carter Radio Co.
CHICAGO

Big Money in Radio

Demand for high pay radio men is so great that a big Kansas City wholesale concern is now fitting men free to get into the radio business for themselves and make \$60 to \$200 a week without any capital invested. Select territory open. Send today for free catalog and amazing offer. Write direct to Mr. H. J. Saizow, Standard Radio Co., 1440 Walnut St., Kansas City, Mo.

Hear What YOU Like

YOUR OWN Name and Address Printed Free on Applause Cards Stations gladly put on numbers you request. We print special cards that get ATTENTION. Applaud your favorites.
FREE LOG with 1st Order
Quality cards. High grade printing. All the rage. 100—\$1.45; 200—\$1.95; 300—\$2.45. Money refunded if not delighted.
Send No Money, just pay postman when you get cards and FREE Log. Order NOW.
Radio Printers, Dept. 8919, Marengo, Ill.

AMBASSADOR
KFI LOS ANGELES
SEND FOR FREE 4 PAGE COIL FOLDER
COILS GOT KF ON INDOOR ANTENNAE VERIFIED ONLY 2 TUBES
AMBASSADOR SALES CO. 108 Greenwich St., N.Y.

ARE YOU THE MAN

to be first in your town to sell and demonstrate POWEROLA, the famous 5 tube NO-BATTERY ELECTRIC LIGHT SOCKET RADIO RECEIVER (not an attachment), universal for D.C. or A.C. (100-115 v., 40-60 cycle), now sold and demonstrated by THE NEW YORK EDISON CO., public utility companies and radio, electric and music dealers everywhere. Absolutely dependable, fully guaranteed, powerful, practical, perfect in performance.

Are You the Man Who Sees Opportunities Ahead for Real Money Making?
Write for literature, terms and prices at once.

You, Too, Can Make Powerola
Send \$1.00 for wiring designs showing parts used and how to make any set or circuit (one to eight tubes) operate satisfactorily from A.C. or D.C. current.
POWEROLA RADIO CORP.
Dept. R.D., 1845 Broadway New York

GO into the RADIO BUSINESS
We specialize in Equipping New Dealers with entire stock—advice free.
Send for Our Radio CATALOG & BARGAIN LISTS
Wholesale Only
MANHATTAN RADIO COMPANY
112 Trinity Place New York City

GET THIS BIG RADIO CATALOG FREE
Simply send name TODAY for big 64-page book explaining liberal proposition paying agents \$60 to \$100 a week, and how to make money from latest radio goods.
Live dealers and agents wanted
Standard Radio Co., 1442 Walnut St., Kansas City, Mo.

New Revisable LOG
Loose Leaves—Large Colored Radio Map FREE
New 64 page log. Corrected sheets published as changes in calls, wave lengths, owners, addresses, etc., occur. 504 stations. 4 dial settings, remarks, etc. Tuning suggestions. Station lists by wave lengths—by states, etc. Trouble aids. Dictionary Radio Terms, Repair Hints, Trouble Preventers. Other valuable information. So convenient. Worth many times small cost. Only \$1. Pay postman after log and large FREE map arrive. Postpaid if pay with order. Money refunded if not delighted. Order today—now. Postal will do.
Radio Printers, Dept. 9919, Marengo, Ill.

Radio Dealers WANTED!
If you are the type of dealer who hustles after business, who isn't content to wait for trade to come in but who takes sets out to demonstrate, can talk and sell quality merchandise, and knows Radio values, we have a big proposition for you. Are you that dealer?
This Means More Money for You
Our location at Kansas City, the great center of distribution of the United States, enables us to give quicker service and unusual satisfaction. We manufacture a complete line of high grade receivers and sell to dealers only. We are distributors for more than 225 Nationally advertised lines.
Write today for amazing offers, new 112-page catalog and regular monthly catalogs of latest merchandise—all free.
AMERICAN RADIO MFG. CO.
1416-18 McGee St., Dept V, Kansas City, Mo.

FREE RADIO ALBUM

For limited time, we will give ABSOLUTELY FREE a 48 PAGE Radio Album and Log, containing lists of stations alphabetical by states and cities—also by call letters, with each order for 168 beautiful copper-etched American, Canadian and European radio stamps (8 colors) each with call letters of a station. As you hear stations, insert proper stamps. A fascinating hobby. A permanent record of stations heard. You and your children and friends will enjoy it.

Send No Money
Pay postman \$1 after stamps and FREE album arrive. We prepay postage if you prefer to pay with order. MONEY REFUNDED if not DELIGHTED. Send order today—NOW. Postal will do.

IDEAL CO., Dept. 9919, 366 Wrigley Bldg., Chicago

World Storage Batteries
32 Cells 24 Volts
RADIO Storage "B" Battery
Lasts Indefinitely—Pays for Itself
Economy and performance unheard of before. Recharged at a negligible cost. Approved and listed as Standard by leading Radio Authorities, including Pop. Radio Laboratories, Pop. Sci. Inst. Standards, Radio News Lab., Letax, Inc., and other important institutions. Equipped with Solid Rubber Case, an insurance against acid and leakage. Extra heavy glass jars. Heavy, rugged plates. Order yours today!
SEND NO MONEY Just state number of batteries order is received. Extra Offer: 4 batteries in series (36 volts) \$12.75. Pay expressman after examining batteries. 5 per cent discount for cash with order. Mail your order now!
WORLD BATTERY COMPANY
1219 So. Wabash Ave., Dept. 76 Chicago, Ill.
Prices: 6-volt, 100 Amp. \$11.25; 120 Amp. \$13.25; 150 Amp. \$14.00. All equipped with Solid Rubber Cases.
World STORAGE BATTERIES
Set your Radio Dials at 2100 meters for the new 1000 watt World Storage Battery Station. W.S.B.C., Chicago. Watch for announcements.

Radiohone Broadcasting Stations

Corrected Every Week—Part I

United States

AT9, Fort Bragg, N. C. 435 meters. 750 watts. U. S. Government. Announcer, Lieut. James Y. LeGette. Slogan, "The Pioneer Broadcasting Station of the Army." Tues, Thurs, Sat, 8-9:55 pm, dance music, talks, bands, fights. Sun, 8-9:55 pm, service. Eastern.

KDKA, E. Pittsburgh, Pa. 309.1 meters. 1,000 watts. Westinghouse Elec. & Mfg. Co. Announcer, H. W. Arlin. Slogan, "The Pioneer Broadcasting Station of the World." Daily ex Sun, 9:45-10 am, 11:55, time, 12, markets, reports, weather; 2:30-5:30, music; 7-9:55, time, daily except Sun, Sat; 12:15 pm; 7:30-9 pm, talks. Daily ex Sat, Sun, 8:30 pm; 8:45, concert; 9:55, time. Sat, 8:45 pm, concert; 9:55, time. Tues, Thurs, 10:30 pm. Sun, 9:45 am, 3 pm, 3:45, 6:45, Eastern.

KDLR, Devils Lake, N. Dak. 231 meters. 5 watts. Radio Elec. Co.-Wilson Ins. Agency. Daily ex Sun, 12:10 pm, weather; orchestra; 6:15, markets. Mon, 9:30-11:30 pm, Sun, 11 am, church. 4:30-6, Central.

KDPM, Cleveland, O. 250-1817 meters. 750 watts. Westinghouse Elec. & Mfg. Co. Announcer, H. W. Irving. Experimental station.

KDYL, Salt Lake City, Utah. 246 meters. 50 watts. *Newhouse Hotel. Announcer, Gene Pack. Slogan, "Out on the Great Divide." Daily ex Sun, 3-4 pm, 6:30-8, news, music, entertainment. Sun, 11-1 am, Mountain.

KDZB, Bakersfield, Calif. 209.7 meters. 100 watts. Frank Siefert. Daily ex Sun, 8-9 pm, reports, music. Pacific.

KFAB, Lincoln, Neb. 340.7 meters. 1,000 watts. Nebraska Buick Auto Co. Announcer, Gayle Greig. Daily ex Sun, 9:30-9:55 am, weather reports; Mon, Tues, Wed, Fri, 10:30-11 am, talks; 1:15-1:30 pm, high school; 3-3:30 pm, educational talks. Mon, Wed, Fri, 8:05-8:30 pm, agricultural talks. Daily ex Sun, Thurs, 5:30-6:30 pm, Tues, Wed, Fri, Sat, 8:30-10:30 pm, Sun, 4-5 pm, Central.

KFAD, Phoenix, Ariz. 273 meters. 100 watts. Electrical Equip. Co.-McArthur Brothers Mercantile Co. Announcer, Arthur C. Anderson. Slogan, "The Voice of the Atwater Kent Radio." Daily ex Sun, Mon, 6-7 pm, 8-9. Daily ex Sun, Wed, 6-7 pm; 9-11, concerts, news stocks. Mountain.

KFAF, San Jose, Calif. 217.3 meters. 50 watts. Alfred *Powell.

KFAJ, Boulder, Colo. 261 meters. 100 watts. Univ. of Colo. Announcer, F. M. Orsborn. Tues, Sat, 9 pm, time, music, addresses by faculty. Thurs, 7:30 pm Sat, 2:30-5 pm, sports. Mountain.

KFAU, Boise, Idaho. 282.8 meters. 750 watts. Boise H. S. Announcer, Hoyt Cooper. Slogan, "Idaho Station." Daily ex Sat, Sun, 4-4:45 pm, markets, weather, news. Mon, 7:30-9 pm, concert. Thurs, 8-10 pm, concert. Sun, 7:30-8:30 pm, church service. Mountain.

KFBB, Harre, Mont. 275 meters. 50 watts. F. A. Buttery Co. Announcer, C. O. Boettger. Daily ex Sun, 12:45 pm, music, markets, weather, reports. Mountain.

KFBC, San Diego, Calif. 244 meters. 100 watts. W. K. Azbill. Sun, 9-10 am, Bible lesson, sermon. Tues, Thurs, 8-9 pm, Pacific.

KFBL, Sacramento, Calif. 248 meters. 100 watts. Sacramento Bee. Mon, Tues, 7:30-10 pm, Pacific.

KFBL, Everett, Wash. 224 meters. 100 watts. Lesse *Bros. Daily, 7:30-8:30 pm, Pacific.

KFBS, Trinidad, Colo. 238 meters. 15 watts. School District No. One.

KFBU, Laramie, Wyo. 270 meters. 500 watts. Bishop N. S. Thomas.

KFCB, Phoenix, Ariz. 238 meters. 100 watts. Nielsen Radio Supply Co. Announcer, E. A. Nielsen. Slogan, "When It's Wintertime in Michigan, It's Summer Time Down Here." Daily 7-7:30 pm, bedtime stories. Mountain.

KFCF, Walla Walla, Wash. 256 meters. 100 watts. Frank A. Moore. Slogan, "The Valley They Liked So Well They Named It." Mon, 8-10 pm, Thurs, Fri, 8-12 midnight, Pacific.

KFDD, Boise, Idaho. 275 meters. 50 watts. St. Michael's Episcopal Cathedral. Announcer, E. Mark Hanford. Sun, 11:15-12:30 pm, 7:30-9:15, Mountain.

KFDJ, Corvallis, Ore. 282.8 meters. 500 watts. Oregon *Agricultural College.

KFDM, Beaumont, Tex. 315.6 meters. 500 watts. Magnolia Petroleum Co. Announcer, Magnolene Mike. Slogan, "Call for Dependable Magnolene." Tues, Fri, 12:30-12:55 pm, band concert; 7-7:30, children's hour; 8-10:30, concerts. Sun, 11-12 m, 8-9 pm, Central.

KFDX, Shreveport, La. 250 meters. 100 watts. First Baptist church. Announcer, Hugh Clancy. Sun, 10:50 am, 7 pm, Wed, 9-10 pm, Central.

KFDZ, Minneapolis, Minn. 231 meters. 10 watts. Harry O. Iverson.

KFEC, Portland, Ore. 248 meters. 50 watts. Meier & Frank Co., Inc. Daily ex Sun, 12 m, weather, reports; 4-5 pm, music; 6:30 pm, weather, crop, markets, reports. Sat, 11 am-12 m, children's hour. Pacific.

KFEL, Denver, Colo. 254 meters. 50 watts. W. L. Winer. Inc. Announcer, Eugene P. O. Fallon. Daily ex Sun, 11 am, 2 pm, 4 Thurs, Sat, 8-12 midnight, Sleep Wrecker program. Mountain.

KFEG, Oak, Nebr. 268 meters. 500 watts. J. L. Scroggin. Announcer, G. G. Scroggin. Daily ex Sun, 2-3 pm, orchestra. Sun, 4:30-6 pm, Central.

KFEV, Kellogg, Ida. 268 meters. 100 watts. Bunker Hill & Sullivan Mining & Con. Co. Announcer, Walter C. Clark. Slogan, "Voice of the Coeur D'Alene." Closed for the summer.

KFFP, Moberly, Mo. 242 meters. 50 watts. First Baptist Church. Announcer, Granville Ray. Slogan, "The Gospel Messenger of the Air." Pacific.

KFGC, Bay Ridge, La. 268 meters. 100 watts. Louisiana State University. Temporarily off the air.

KFGH, Stanford Univ., Calif. 270.1 meters. 500 watts. Leland Stanford Junior University. No regular schedule.

KFGQ, Boone, Ia. 226 meters. 100 watts. Cray Hardware Co. Announcer, Harold E. Wilcox. Slogan, "Daniel Boone Station." Wed, 8-9 pm. Sun, 8-4 pm, Central.

KFHA, Gunnison, Colo. 252 meters. 50 watts. Western State College of Colorado. Announcer, E. Russell Wightman. "Where the Sun Shines Every Day." Tues, Fri, 6:30 pm, bedtime story; 8 pm, musicale; 10:30, orchestra. Mountain.

KFHL, Oskaloosa, Iowa. 240 meters. 10 watts. Penn College.

KFI, Los Angeles, Calif. 468.5 meters. 5,000 watts. Earle C. Anthony, Inc. Announcer, Glen Rice. Slogan, "The Radio Central Super-Station." Daily ex Sat, Sun, 5:30-6:30 pm, 6:45-11, Sat, 5:30-3 am. Sun, 10-10:45 am, 4-5 pm, 6:30-11, 11-12:30 pm, first and third Sunday of month. Pacific.

KFIF, Portland, Ore. 248 meters. 100 watts. Benson Tech. School.

KFIG, Yakima, Wash. 256.3 meters. 100 watts. First Methodist Church. Announcer, Dr. I. M. Miller. Wed, 7:30 pm, organ. Sat, 7 pm. Sun, 11 am, 7:30 pm, Pacific.

KFIU, Juneau, Alaska. 226 meters. 10 watts. Alaska Elec. Light & Power Co. Announcer, O. E. Shoem-bell. Mon, Wed, Fri, 6-7 pm, Alaskan.

KFIZ, Fond du Lac, Wis. 273 meters. 100 watts. Daily Commonwealth and Wisconsin Radio Sales, Inc. Announcer, Albert Mayer. Daily ex Sun, 5 pm, music, news, markets, weather. Central.

KFJB, Marshalltown, Iowa. 248 meters. 10 watts. Marshall Elec. Co. Announcer, E. N. Peck. Slogan, "Marshalltown, the Heart of Iowa." Daily ex Sun, 10 am, markets. Tues, Fri, 8:30 pm, Central.

KFJC, Junction City, Kan. 218.8 meters. 10 watts. L. B. Fegan.

KFJO, Oklahoma City, Okla. 261 meters. 500 watts. National Radio Mfg. Co. Announcer, Tired Hand. Slogan, "Radio Headquarters." Daily ex Sun, 9:40 am, 12:15 pm, markets; 2:15, markets; 6:30, weather news. Mon, Fri, 8:30-10:30 pm, orchestra. Wed, 7:30 pm, Thurs, 9 pm, band concert. Sun, 10 am, 11, 7:30 pm, Central.

KFJI, Astoria, Ore. 246 meters. 10 watts. E. E. Marsh and Liberty theater. Announcer, E. E. Marsh. Wed, 9:10 pm, organ. Sun, 12:30-1:30 pm, Sun, 10:30-11 pm, Pacific.

KFJM, Grand Forks, N. D. 278 meters. 100 watts. University of North Dakota. Slogan, "Grand Forks, the Educational Center of the State."

KFJR, Portland, Ore. 263 meters. 50 watts. Ashley C. *Dixon & Son. Mon, Tues, Wed, Thurs, 7:30-8 pm, Mon, 8-8:45 pm, Tues, Thurs, 9-10:30 pm, Wed, 8-8:30 pm, Sat, 1:30-3 pm, Pacific.

KFKM, Cedar Falls, Iowa. 253 meters. 50 watts. Iowa State Teachers' College. Educational programs.

KFJY, Fort Dodge, Iowa. 246 meters. 50 watts. Tun- *Wall Radio Co. Announcer, Carl Tunwall. Daily 5:30 pm, markets, news, weather, bulletins, Sun, 11 am, church. Central.

KFIZ, Fort Worth, Tex. 254 meters. 50 watts. South-western Baptist Theological Seminary.

KFKA, Greeley, Colo. 273 meters. 50 watts. Colorado *State Teachers' College. Announcer, Charles F. Valentine. Central.

KFKU, Lawrence, Kan. 275 meters. 500 watts. University of Kansas. Announcer, John F. Patt. Slogan, "Up at Lawrence on the Kaw." Mon, Thurs, 6:55-8 pm, Central.

KFKX, Hastings, Nebr. 288.3 meters. 5,000 watts. *Westinghouse Elec. & Mfg. Co. Slogans, "The Em- press of the Air," "The Pioneer Re-Broadcasting Sta- tion of the world." Daily ex Sat, Sun, 9:30 am, 10:30, 12:30 pm, markets. Mon, Wed, Fri, 9-11 pm, music. Sat, 9:30 am, 10:30, 12:30 pm, Central.

KFKZ, Kirksville, Mo. 226 meters. 10 watts. E. M. *Henry. Mon, Wed, 8-9 pm, dance music. 1st and 3rd Mon, Radio plays. Sun, 4-5 pm, classical music. Central.

KFLB, Albuquerque, N. M. 254 meters. 100 watts. U. & N. M. Announcer, Phillip S. Donnell. Slogan, "The Sunshine Center of America."

KFLU, San Benito, Texas. 236 meters. 10 watts. Benito Radio club. Announcer, B. W. Thacker. Slogan, "Heart of the Magic Valley." Mon, Thurs, Sat, 8:30-10 pm, concert. Sat, 8:30 pm, Sunday school lesson. Central.

KFLV, Rockford, Ill. 229 meters. 200 watts. Swedish Evangelical Mission Church. Announcer, A. T. Frykman. Fri, 8:30 pm. Sun, 12:30 pm, service for shut-ins (Swedish); 9:30, service (English). Central.

KFLX, Galveston, Texas. 240 meters. 10 watts. George R. Clough.

KFPW, Carterville, Mo. 253 meters. 20 watts. St. John M. E. church, S. Slogon, Keeping Pace with Christ Means Progress." Tues, Fri, 8-10 pm, popular program. Sun, 1-3 pm, chapel service. Central.

KFPY, Spokane, Wash. 266 meters. 100 watts. Symons Investment Co. Announcer, E. B. Craney. Daily ex Sun, Tues, 7-7:45 pm, Wed, 9-12, Sun, 9:45-10:30 am; 9-10 pm, Pacific.

KFQA, St. Louis, Mo. 261 meters. 50 watts. The *Principia. Sun, 8 pm, church service. Central.

KFQB, Fort Worth, Tex. 263 meters. 2,500 watts. The *Searchlight Pub. Co. Announcer, Horace B. Greene.

KFQP, Iowa City, Iowa. 224 meters. 10 watts. George *S. Carson, Jr. Wed, 8-9 pm, Central.

KFQU, Holy City, Calif. 217.3 meters. 100 watts. W. Riker. Announcer, Arthur J. Landstrom. Daily ex Mon, 9-10 pm, Sun, 11-12 m, 9-10 pm, Pacific.

KFRW, North Bend, Wash. 215.7 meters. 50 watts. *The Photo Radio and Elec. Shop. Announcer, Carl F. Knierim. Slogan, "At the Western Entrance of Snoqualmie Pass." Thurs, 8-9 pm, Sun, 8:45-10 pm, Pacific.

KFQZ, Hollywood, Calif. 226 meters. 50 watts. Taft *Radio company. Tues, Fri, 9-11 pm, Pacific.

KFRB, Beeville, Tex. 243 meters. 250 watts. Hall *Bathers. Temporarily off the air.

KFRS, San Francisco, Calif. 268 meters. 50 watts. City of Paris Dry Goods Co.

KFRM, Fort Sill, Okla. 242 meters. 50 watts. James P. Boland.

KFRU, Columbia, Mo. 499.7 meters. 500 watts. Steph- *ens college. Mon, Tues, Thurs, Fri, 6:15 pm, Fri, 12-2 am, Central.

KFRV, Olympia, Wash. 218.8 meters. 50 watts. "The *Loy Memorial." United Churches of Olympia. Slogan, "Make the World a Brotherhood." Thurs, 9-10 pm, Sun, 11-12:15 pm, 7:30-9, Pacific.

KFRY, State College, N. M. 266 meters. 50 watts. New Mexico College of Agriculture and Mechanic Arts.

KFSG, Los Angeles, Calif. 275 meters. 500 watts. Angeles Temple. Tues, Thurs, Fri, Sat, 3:30-4:30 pm, Tues, 6:30-7:30 pm, Wed, 2:30-4:30 pm; 6:30-

KFWA, Ogden, Utah. 261 meters. 500 watts. Brow- ing Brothers Co. Announcer, H. C. Mailander. Slogan, "Keeping Friends with All." Daily ex Sun, 4-5 pm, Zenith hour, stocks, markets, time. Mon, Wed, Fri, 9-10 pm, music. Mon, Wed, 10-11 pm, Sun, 9-12 midnight, music. Mountain.

KFWB, Hollywood, Calif. 252 meters. 500 watts. War- ner Brothers.

KFWC, Upland, Calif. 211.1 meters. 50 watts. L. E. Wall.

KFWF, St. Louis, Mo. 214.2 meters. 250 watts. St. *Louis Truth Center. Slogan, "The Voice of Truth." Announcer, Rev. Charles H. Hartmann. Tues, 8 pm, Wed, 12 m, Thurs, 7 pm, 7:45; Fri, 12 m; Sat, 11 pm, Sun, 10:45 am; 7:45 pm, Central.

KFWH, Chicago, Calif. 254 meters. 100 watts. F. Wellington Morse, Jr. Slogan, "Kind Friends We're Here." Daily 6:30-7:15 pm, dinner concerts. Daily ex Sun, 6:15-6:30 pm, news, music. Mon, Wed, Fri, 8-10 pm, Pacific.

KFWI, South San Francisco, Calif. 226 meters. 500 *watts. Radio Entertainments, Inc.

KFWM, Oakland, Calif. 206.8 meters. 500 watts. Oak- land Educational Society.

KFWO, Avalon, Calif. 211.1 meters. 250 watts. Major Lawrence Mott-Signal Corp. Slogan, "Katalina for Wonderful Outings." Daily, 7:30-9 pm, Tues, Thurs, Fri, Sun, 5-6 pm, Pacific.

KFWP, Brownsville, Tex. 214.2 meters. 10 watts. Rio Grande Radio Supply House.

KFWU, Pineville, La. 238 meters. 100 watts. Louisiana, La.

KFWV, Portland, Ore. 212.6 meters. 50 watts. Wilbur *Jerman.

KFXB, Big Bear Lake, Calif. 202.6 meters. 500 watts. Bertram O. Heller. Announcer, Charles Stillwell. Slogan, "Rim of World Super Station." Mon, 5-5:30 pm; 9-11. Daily ex Sun, 8-9 pm, Pacific.

KFXC, Santa Maria, Calif. 209.7 meters. 100 watts. Santa Maria Valley Railroad Company.

KFXD, Logan, Utah. 205.4 meters. 10 watts. Service *Radio Co.

KFXE, Waterloo, Ia. 236 meters. 100 watts. Electrical Research & Mfg. Co. Announcer, G. Pelton.

KFXF, Colorado Springs, Colo. 250 meters. 500 watts. *Pikes Peak Broadcasting Company. Announcer, W. D. Pyle. Slogan, "The Pikes Peak Station."

KFXH, El Paso, Tex. 242 meters. 50 watts. Bledsoe Radio Company. Slogan, "The Voice of the Rio Grande." Mon, Wed, Fri, 8-10 pm, Mountain.

KFXJ, Colorado. 215.7 meters. 10 watts. Mountain States Radio Distributors, Inc. (Portable).

KFXM, Beaumont, Tex. 227 meters. 100 watts. Neches Elec. Co.

KFXV, Flagstaff, Arizona. 205.4 meters. 50 watts. Mary M. Costigan.

KFYF, Oxnard, Calif. 205.4 meters. 10 watts. Carl's *Radio Den. Announcer, Carl Newcomb. Slogan, "Voice of the Sugar City." Daily ex Sun, 5-6 pm, weather, crops, news. Pacific.

KFYJ, Houston, Texas. 238 meters. 10 watts. Houston *Chronicle Pub. Co.

KFYR, Bismarck, N. D. 248 meters. 10 watts. Hos- *kins-Meyer, Inc.

RGB, Tacoma, Wash. 250 meters. 100 watts. Tacoma *Daily Ledger. Pacific.

KGO, Oakland, Calif. 361.2 meters. 3000 watts. Gen. Elec. Co. Announcer, Howard L. Mitholland. Daily ex Sun, 7:15-7:45, 8:15, am, exercises; 8:30, stock strength; 11:30 am, luncheon concert. Daily ex Sat, Sun, 1:30 pm; Sat, 12:30 pm, markets, weather. Mon, Wed, Fri, 3 pm, music. Daily ex Sun, Mon, 4-5:30 pm, concert orchestra. Mon, Tues, Wed, Fri, 6-7 pm, music; Mon, Tues, Thurs, Sat, 8-10 pm lectures, music. Thurs, Sat, 8-12, Mon, 5:30-6 pm, Children's half hour. Mon, Tues, Wed, Thurs, Fri, 7 pm, stocks, markets, weather, baseball. Thurs, 5:30-6:30 pm, boys' hour. Fri, 5-5:30 pm, girl's half hour; Sun, 11-12 m, 8 pm, church services; 3:30-5 pm, Little Symphony orchestra. Pacific.

KGTT, San Francisco, Calif. 234 meters. 50 watts. *Glad Tidings Tabernacle.

KGU, Honolulu, Hawaii. 270 meters. 500 watts. Marion A. Mulrony, The Honolulu Advertiser. Announcer, W. K. Karmen. Daily, 7:30-9 pm, Tues, Thurs, Sat, special program. Sun, 11 am; 7:30 pm. 150 meridian. 2 1/2 hours earlier than Pacific.

KGW, Portland, Ore. 491.5 meters. 500 watts. Port- land Morning Oregonian. Announcer, Dick Haller. Slogan, "KGW, Keep Growing Wiser." Daily ex Sun, 10:30-11 am, Town Crier; Mon, Wed, Fri, 7:15-7:30 am, exercises. Daily ex Sun, 12:30-1:30 pm, Mon, Tues, Wed, Thurs, Fri, 7:30-7:45 pm, utility service; Mon, Tues, Wed, Fri, 8-9 pm, Mon, Tues, 9-10 pm, Tues, Sat, 10-12, Wed, 9-11 pm, Fri, 9-10:30 pm; 10:30-12, Hoot Owls. Sun, 10:30-12 m, 7:30-9, Pacific.

KGY, Lacey, Wash. 246 meters. 50 watts. St. Martins Coliere. Announcer, Sebastian Ruth. Slogan, "Out Where the Cedars Meet the Sea." Sun, Tues, Thurs, 8:30-9:30 pm, Pacific.

KHI, Los Angeles, Calif. 405.2 meters. 500 watts. Los Angeles Times. Announcer, John S. Daggett. Slogan, "Kindness, Happiness, Joy." Daily ex Sun, Mon, 7 am, 7:30, 12 m, 1:30 pm, 2:30, 3:30, 5:30, 11, Mon, 7-7:30 am, 12-1:30 pm. Sun, 10-12:30 pm, 6-7:30, 8-11, Pacific.

KHQ, Spokane, Wash. 273 meters. 500 watts. Louis *Wasmer, Inc. Announcer, Frank A. Buhler. Slogan, "In the Friendly City."

KIAF, Shtepoc, Minn. 422.3 meters. 500 watts. Steele Co. Slogan, "Far from the Maddening Crowd." Mon, Wed, Fri, 7-8 pm, Pacific.

KJBS, San Francisco, Calif. 220 meters. 5 watts. *Julius Brunton & Sons Co. Announcer, Edward Ludes. Daily ex Sun, 9-10:40 am; 2-2:30 pm. Mon, Wed, 8-10 pm, Fri, 8-11:30 pm. "Royal Order of Smoked Herring." Pacific.

KJR, Seattle, Wash. 384.4 meters. 1000 watts. North- west Radio Service Co. Announcer, Ross W. Swift. Slogan, "Radio Headquarters." Daily ex Sun, 10:30-11:30 am, educational program; 1 pm, time; 1:15-2, organ; 2-2:15, cooking; 2:15-2:30, produce report; 5-6 pm, stocks; time; 6-6:30, theater news; 7-11, 10, time. Sun, 11-12:30 pm, service; 7-7:30, organ; 7:30-9, service; 9-10, Pacific.

KLDS, Independence, Mo. 440.9 meters. 1,000 watts. *Reorganized Church of Jesus Christ of Latter Day Saints. Announcer, Arthur B. Church. Tues, Thurs, 8 pm, Sun, 11 am, 6:30 pm; 9, Central.

KLS, Oakland, Calif. 250 meters. 250 watts. Warner *Bus Radio Supplies. Announcer, S. Warner. Slogan, "The City of Golden Opportunity." Sun, 10-11 am, Pacific.

KLX, Oakland, Calif. 508.2 meters. 500 watts. Oakland *Tribune. Announcer, Charles H. Gabriel, Jr. Slogan, "Where Rail and Water Meet." Mon, Fri, 6-7:30 pm; 8-10:30, Tues, Wed, Sat, 7-7:30 pm, Tues, 6-7:30 pm, Wed, 8-11:30 pm, Pacific.

KLZ, Denver, Colo. 266 meters. 250 watts. Rey- nolds Radio Co. Announcer, Mrs. William D. Reynolds. Slogan, "It's a Privilege to Live in Colo- rado." Closed for the summer.

KMA, Shenandoah, Ia. 252 meters. 500 watts. May *Seed & Nursery Co. Daily ex Sun, 11:30-12:30 pm, 6-7, 9-11, Sun, 4-6 pm, Central.

KMJ, Fresno, Calif. 234 meters. 50 watts. Fresno *Bee. Mon, Wed, Fri, 7:15-9:15 pm, Pacific.

KMO, Tacoma, Wash. 250 meters. 100 watts. Asso- ciation Station. (Love Electric Co.) Mon, Wed, Fri, 6-7 pm, popular program; 9-10, artist's program. Pacific.

KMTR, Los Angeles, Calif. 238 meters. 500 watts. *K. M. Turner Radio Corp.

KNRC, Los Angeles, Calif. 208.2 meters. 250 watts. *Kierulff & Ravenscroft Co. Announcer, "Hastings." Daily ex Sun, 10 am, Mon, 1:30 pm, Tues, Wed, Thurs, Fri, 7-9 pm, Pacific.

CHALLENGE!

ONE DOLLAR will be paid to the Radio fan submitting the most errors in any one station's listing in this directory. Letters must reach Radio Digest office not later than one week from date of issue corrected. Readers are not limited to correcting one station, but such corrections must be certified by the stations themselves, and NOT by comparison to other so-called accurate broadcasting directors and lists. Readers also must live in same state or province as stations corrected are located. Station verifications must accompany corrections.

That's just how sure Radio Digest is that this broadcasting station directory is correct! To make the challenge fair for everyone, broadcasting stations and their employes are barred from this offer. Why? Because the broadcasters are the source of all the data given herein. They are (or should be) interested enough to answer the inquiry sent them every time data on their station appears. This inquiry contains a proof of their last listing and must either be corrected or O K'd as correct and returned to the Digest. Nevertheless,

sometimes the stations are careless and mistakes are made. But Radio Digest is so sure of the exactness of this directory that this challenge is made unconditionally.

With reference to the directory: It appears in six parts, serially continuously; the first four parts are station data listings, arranged alphabetically; the fifth part is a state, city index of stations; the sixth part is a wave length index. The information contained in each station data listing is given in the following order: Call letters, city, state, wave length used, watts antenna input, owner's name, announcer's name, slogan used if any, name of listener in "club," schedule of operating hours, and kind of time used, as "Central," "Moun- tain," etc. Asterisks have been placed in front of corrected listings and new stations in order to distinguish these.

Six successive issues of Radio Digest will give one the most complete and accurate list of broadcast- ing stations obtainable. This service is original with this publication, and has been maintained from the start. Right of reproduction without permission of any or all of the data contained herein is denied.

KFLZ, Anita, Iowa. 273 meters. 100 watts. Atlantic Automobile Co. Operated by Walnut Grove Hog Remedy Co. Announcer, H. A. Marshall. Daily ex Sun, 11:50-12:15 pm, question box, markets. Tues, Thurs, 8:30-10 pm, music. Central.

KFMQ, Fayetteville, Ark. 299.8 meters. 750 watts. U. of Arkansas. Mon, 7:30 pm. Tues, Thurs, 8 pm, Central.

KFMR, Sioux City, Ia. 261 meters. 100 watts. Morn- ingside College. Announcer, Jesse C. Ducommun. Wed, 9:15 pm, Central.

KFMW, Houghton, Mich. 263 meters. 50 watts. M. G. Sateren (announcer). Sun, 3-4:30 pm.

KFMX, Northfield, Minn. 336.9 meters. 500 watts. Carlton College. Announcer, Merrill O. Bolen. Tues, Fri, 9:30 pm, Wed, 9 pm, Sun, 7 pm, vesper. Central.

KFNF, Shenandoah, Ia. 266 meters. 500 watts. Henry Field Seed Co. Announcer, Henry Field. Slogan, "Friendly Station in a Friendly Town." Daily ex Sun, 9, 10, 11 am, 12:15-1:30 pm, 3-4, 7-9 pm, Sun, 10:45 am, 2:30 pm, 3-4, services; 6:30-7:30, Golden Rule; 7:30-8:30, church service. Central.

KFOA, Seattle, Wash. 454.3 meters. 1,000 watts. Rhodes *Dept. Store. Slogan, "The Gateway to the Orient." Daily ex Sat, Sun, 12:30-1:30 pm. Daily ex Sun, 4-5:15, Times bulletins, concert. Daily ex Sun, Thurs, 6-6:45 pm, 8:30-10 pm, Times program. Mon, Wed, Fri, 6:45-8:15 pm, studio music. Tues, Fri, Sat, 10-11:30 pm, orchestra. Pacific.

KFOB, Burlingame, Calif. 226 meters. 50 watts. Bur- ington KFOB Inc. Daily, 8-10 pm, Pacific.

KFOJ, Moberly, Mo. 242 meters. 10 watts. Moberly High School.

KFON, Long Beach, Calif. 233 meters. 500 watts. *Echophone Radio Shop. Slogan, "Where Your Ship Comes In." Daily ex Sun, Mon, 10-11 am; 2:30-5 pm; 6-11, Mon, 10-11 am; 6-11, Sun, 2:30-4 pm; 8-9, Pacific.

KFOO, Salt Lake City, Utah. 236 meters. 250 watts. Latter Day Saints University. Announcer, Don C. McRae.

KFOR, David City, Nebr. 226 meters. 100 watts. David *City Tire & Elec. Co. Slogan, "The Voice of David City." Announcer, Howard A. Shuman. Tues, Fri, 6:30-7:30 pm, Central.

KFOT, Wichita, Kansas. 231 meters. 50 watts. Col- lege Hill Radio Club. Announcer, Leon Garnett. Slogan, "Radiocasting Church." Sun, 11-12:30 pm, 7:30-9, church services. Mon, 9-10:30 pm, music. Central.

KFOX, Omaha, Nebr. 248 meters. 100 watts. Board of Education. Technical High.

KFOY, St. Paul, Minn. 252 meters. 50 watts. Beacon Radio Service. Thurs, 11-12 m, Sun, 8:30-4:30 pm, Central.

KFPL, Dublin, Tex. 252 meters. 15 watts. C. C. Baxter, announcer.

KFPM, Greenville, Tex. 242 meters. 10 watts. The New Furniture Co. Announcer, Dave Ablowich, Jr. Slogan, "The New Furniture Co., the Home of Good Furniture." Located at Greenville, Texas, Where You Find "The Blackest Land, the Whitest People." Daily ex Sun, 2 pm, music. Tues, Wed, Thurs, Fri, 8 pm, Sun, 11 am, services; 7:30 pm, irregularly. Central.

KFPR, Los Angeles, Calif. 231 meters. 500 watts. Los Angeles Co. Forestry Dept. Irregular schedule.

7:30, Thurs, Fri, Sat, 7:30-11 pm, Sun, 10:30-12:30 pm, 2:30-4:30, 7-9:30, Mon silent. Pacific.

KFUJ, Breckenridge, Minn. 242 meters. 50 watts. Hoppert Plumbing & Heating Co. and Hoppert Radio Electric Co. Announcer, F. H. Rettig. Slogan, "Where the Red River of the North Finds Its Source." Daily ex Sun, 10:30 am, 5:40 pm, weather. Daily ex Sun, 10:40 am, 1:30 pm, 5:45 pm, markets. Mon, Wed, 8-9 pm, Central.

KFUL, Galveston, Texas. 258 meters. 50 watts. Thomas Groggan & Bros.

KFUM, Colorado Springs, Colo. 242 meters. 100 watts. W. D. Corley. Slogan, "Known for Unsurpassed Mountain Scenery." Tues, Sat, 8:30-10:30 pm, Sun, 11 am, 7:30 pm, Mountain.

KFUO, St. Louis, Mo. 545.1 meters. 500 watts. Con- cordia Theological Seminary (Lutheran). Announcer, Herm. H. Hohenstein. Mon, 8 pm, Wed, 9:15 pm, Sun, 9:15 pm, Central.

KFUP, Denver, Colo. 234 meters. 50 watts. Fitzsimons *General Hospital, Educational and Recreational Dept.

KFUR, Ogden, Utah. 224 meters. 100 watts. Peery Building Co. Tues, Thurs, Sat, 9:50-11:50 pm, dance, music. Mountain.

KFUS, Oakland, Calif. 256 meters. 50 watts. The Sher- man School. Slogan, "The City of Opportunity."

KFUT, Salt Lake City, Utah. 261 meters. 100 watts. *University of Utah. Tues, Thurs, 4-5 pm, Mountain.

KFUV, Oakland, Calif. 220 meters. 50 watts. Mathew- son Motor Co. Announcer, H. C. Colburn. Slogan, "The Voice of Automobile Row." Daily ex Sun, 10:45-11:30 am, 6:30-7:15 pm, Tues, Thurs, 8-10 pm, Sat, 8-11 pm, Sun, 8-9:30 pm, Pacific.

KFVD, San Pedro, Calif. 205.4 meters. 50 watts. McWhinnie Elec. Co.

KFVE, University City, Mo. 240 meters. 500 watts. *Film Corp. of America. Daily ex Thurs, Sun, 8:30-10 pm, Central.

KFVG, Independence, Kan. 236 meters. 10 watts. First Methodist Episcopal church. Sun, services.

KFVH, Manhattan, Kan. 218.8 meters. 15 watts. Whan *Radio Shop. Announcer, Herbert Wahn. Slogan, "Kansas Fans Very Happy." Daily ex Sun, 12 m, markets. Daily ex Sun, Central.

KFVI, Houston, Texas. 240 meters. 10 watts. Head- quarters Troop 56th Cavalry Brigade.

KFVN, Welome, Minn. 227 meters. 50 watts. Carl *E. Bagley. Slogan, "The Voice of Martin County." Daily ex Sun, 9 pm, Sun, 3 pm, Central.

KFVR, Denver, Colo. 244 meters. 50 watts. Moon- light Ranch Broadcasting Station. Mon, Fri, 10-12 midnight, Tues, Sat, 8-9 pm, Wed, Thurs, 12-1 am, Mountain.

KFVS, Cape Girardeau, Mo. 224 meters. 50 watts. *Cape Girardeau Battery Station. Announcer, W. W. Watkins. Slogan, "The City of Opportunity." Thurs, 7 pm, Central.

KFVU, Eureka, Calif. 209.7 meters. 5 watts. Standard Pub. Co. Slogan, "On the Redwood Highway." An- nouncer, B. M. Ellis. Daily ex Sun, 12:30 pm, mar- kets, news; 6:30, Mon, Fri, 8-10 pm, Wed, 8-12 mid- night, Pacific.

KFVW, San Diego, Calif. 245.8 meters. 500 watts. *Airfan Radio Corp.

KFVY, Albuquerque, N. M. 250 meters. 10 watts. Radio Supply Co. Announcer, J. F. Walsh. Slogan, Center of the Sunshine State." Daily ex Sun, 5:30-8:30 pm, dinner concert; baseball. Tues, Fri, 8-9:30 pm, dance music. Mountain.

(Note—The second part of the station data list will appear next week.)

ATWATER KENT RADIO

**“Now I can jump from one station
to another without leaving my chair**

“IT'S A GREAT COMFORT, I tell you,” said a veteran radio enthusiast the other day.

“I never knew what real radio enjoyment was until I tucked this new Atwater Kent set among my books and smoking things on this little table.

“My old set was across the room. It was so big and bulky that it had to have a table all its own. Compared with this Model 20 Compact it seems as cumbersome as an old-fashioned limousine.

“Every time I'd get comfortably settled, the station we were hearing would change its program or sign off. That meant getting up, crossing the room, finding another station and going back to my chair.

“I wish I'd had a pedometer some nights! I'll bet I walked miles!

“But with this little fellow at my elbow, I'm settled for the evening.

“It's right at home among my papers, magazines and tobacco. Everything I need for the evening is on the same small table.

“And when I want to find a new station, it's as easy as reaching for a cigarette.

“But the best part of it is that with its small size, the Compact has all the power and pep of a big set.

“All the same parts are there—five tubes and all—just re-arranged to save space. It will do anything a big set will do.

“It's got a great big heart in a mighty small body. It's the baby grand of radio!”

Model 20 Compact
Price, \$80

Hear the Atwater Kent Radio Artists every Sunday evening at 9:15 o'clock (Eastern Standard Time) through stations—

WEAF New York
WJAR Providence
WEEI Boston
WCAP Washington
WSAI Cincinnati
WCCO Minn.-St. Paul
WFI Philadelphia
WOO } alternating
WCAE Pittsburgh
WGR Buffalo
WOC Davenport
WTAG Worcester
KSD St. Louis
WWJ Detroit
WLIE Chicago
WEAR Cleveland

Prices slightly higher
from the Rockies west and in
Canada

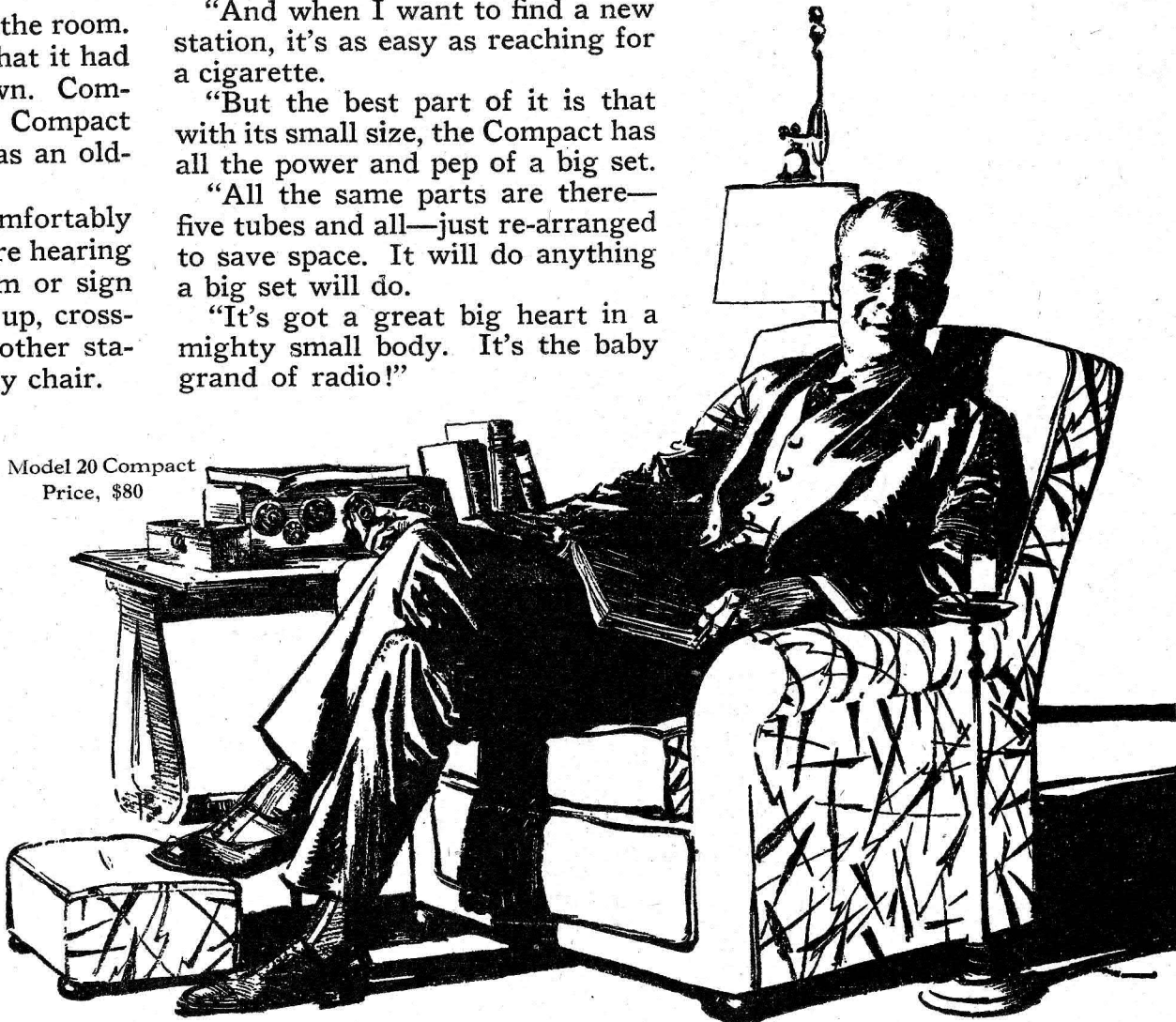

Write for illustrated booklet telling the story of Atwater Kent Radio

ATWATER KENT MANUFACTURING COMPANY

A. ATWATER KENT, President

4708 Wissahickon Ave.

Philadelphia, Pa.