

3-Tube Neutrodyne; Flewelling; Grimes Reflex

Radio Digest

EVERY
WEEK

Illustrated

TEN
CENTS

REG. U. S. PAT. OFF. & DOM. OF CANADA

Vol. VII

Copyright 1923
By Radio Digest Publishing Co.

SATURDAY, DECEMBER 29, 1923

No. 12

RADIO UNITES CHURCHES

"TINY TIM" GIVEN HIS RECEIVING SET

BRINGS HAPPINESS TO LITTLE CRIPPLE

Lawrence Comes Home from School and Finds His Heart's Desire

CINCINNATI.—There is no happier child in the world than Lawrence Hundermer, of this city, the real "Tiny Tim" of Radio, a helplessly crippled little boy to whom a Radio receiving set was given recently by the Crosley Manufacturing Co.

Not long ago Station WLW suggested that there might be some of the listeners who would like to help purchase a tube set for this little fellow. A fund was raised and one day last week the complete outfit was taken to his home. Lawrence was in school. The receiver was hooked up. Soon a school bus stopped at the door and the driver carried the little cripple into the house. The first thing he saw was his new set. His face beamed, but he was speechless. His mother was crying.

The happy boy, whose crippled legs and twisted back make him absolutely helpless, was lifted into a chair and the phones were placed on his head. WLW was broadcasting market quotations.

Tears were in the eyes of everyone present—everyone but Lawrence. His eyes were on the new set.



ALL RELIGIONS JOIN IN PLAN TO BROADCAST

World Peace Is Possible

Report Tells of Station for Vatican in Rome—Creeds See Benefit of Radiophone

By J. L. Newman

CHICAGO.—With the Christmaside has come to an awed and reverent world what is termed a true message of "Peace on earth, good will toward men"; the glad tidings that that ethereal something between the stars which carries the feeble voice of man, Radio, is to be dedicated a messenger of the Messiah.

And millions of the faithful, under the cross, even under the crescent, on desert and moor, in valley and on mount, will soon bow head or bend knee, it is prophesied, in homage to the word of God as it vibrates through the ether.

Creeds May Unite for Peace Radio

Because of the universality of Radio as a means of communication, the chasms of the creeds may soon be bridged, predict various leaders, and what they call the greatest curse to man—war—may, within the minds of those who now read, be but a hideous memory.

(Continued on page 2)



Alice Brady, star of film and stage, recently gave an interesting beauty talk from station WJAX, Union Trust Co., Cleveland. Miss Brady has been heard from many stations

How even a little lame girl may dream of love was described by Sara Southern, one of the stars of "The Fool," when she spoke from Station WMAQ, the Chicago Daily News. Channing Pollock, producer of the play, is one of the growing number of dramatists who are sold on the advertising value of broadcasting



Alice G. Poyner, prominent violinist, is popular throughout the Pacific coast for her broadcasts from Hale Brothers, KPO

WORLD RADIO PLAN TAKES EYE OF ALL CREEDS

(Continued from page 1)

The world's greatest savants and diplomats, pontiffs and princes, now vision what they describe as the longest stride toward the peace of all peoples since the birth of the Babe of Bethlehem. In these days of travail the various sects have united in one purpose—to cast abroad through the cosmos by means of Radio words of peace and calm, the unctious of the church to those wounded by the woes of the world.

Roman Catholic Church to Broadcast

The courts and chancelleries of Europe, some of the satrapies of the East, the republics of earth—all Christendom—awaits the first international move of its churches to bring religion by means of Radio to humanity.

First to take what is said to be the most momentous step of the kind is the Roman Catholic church. The Vatican will, in a few months, adopt Radio to spread the word of the Pope to millions of devout men and women all over the earth. It is said that official word to this effect will soon be received by prelates of the church in the United States, especially by His Excellency, the Most Rev. Pietro Fumasoni-Biondi, papal delegate to the government in Washington.

Station in the Vatican

Due to the efforts of the company of which Guglielmo Marconi, pioneer Radio inventor, is head, a broadcasting station may soon be operated in the Vatican. By this means Rome will be enabled to transmit the voice of the Holy Father to almost every land. There are in North America more than 37,000,000 Roman Catholics; in South America, 36,000,000; Europe, 184,000,000; Asia, 5,500,000; Africa, 2,000,000, and in Oceania, 9,000,000, a grand total of 273,500,000.

The plans of the Roman hierarchy have not as yet been detailed, but it is considered probable that broadcasting stations will be established or operated by it wherever its cross is raised aloft.

U. S. Protestants Consider Use

Of similar magnitude is the probable scheme of Protestant churches, particularly in the United States. Millions of communicants of and adherents to the various sects in this country may soon be in direct vocal communication with their governing bodies, according to reports emanating from what are considered authoritative sources.

During the last few years the chiefs of Protestant denominations in North America have considered the practicability of Radio as a means of spiritual regeneration. Independently of each other their executives and prominent ministers have used Radio for such purposes as the broadcasting of sermons, Biblical lessons and appeals to the public conscience. But not until the last few months have the national advantages of Radio been deeply considered.

Federal Council to Discuss Broadcasting

As an important part of what is called the world's greatest religious revival the next quadrennial meeting of the Federal Council of Churches of Christ in America, headquarters New York city, may include in its program plans for utilizing Radio in a national scheme to bring the church to the people.

This was the opinion expressed here recently by Dr. Herbert L. Willett of Chicago, one of the executives of the council. "It is likely, too," said he, "that during the next meeting (in New York city on the second Friday in January, 1924) the administrative committee of the council may discuss in detail the use of Radio as a national instrument.

Radio Will Promote Church Unity

"One of the features of the meeting of the executive committee of the Council in Columbus, O., a few days ago, was the wide use of Radio in broadcasting formal addresses. The plant at the University of Ohio, WEAO, was thus used to communicate with hundreds of thousands. That was the first instance in which the various Protestant sects co-operated in sending their messages to the people.

"Radio did it. And our leaders declare that Radio opens a new field for religious effort." The churches realize that by working together they can do more. Radio will enable them to work together as they have seldom worked before.

M. E. Church Utilizes Airphone

Among the leading Protestant churches in America which contemplate a wider use of Radio is the Methodist Episcopal. Its committee on conservation and advance, the leading executive body of the church, may soon consider the national use of Radio, according to Dr. R. J. Wade of Chicago, one of the executive leaders.

As a part of the climax of the centenary of the church, Radio may be used by it from coast to coast and from the Great Lakes to the gulf. The Epworth League, composed of more than 800,000 young men and women of the Methodist Episcopal church, will probably consider the national application of Radio.

It is considered probable that during the meeting in February, in Atlantic City, N. J., of executives of the Presbyterian church in the United States, of which the Rev. Charles Wishart of Wooster, O., is moderator, the national use of Radio may be discussed.

Creeds of World to Confer on Radio

Perhaps the most important phase of the probable international use of Radio by the churches is that in which the Protestant Episcopal church of the United States, generally known as the Episcopal, and other factors with a delegation to be appointed by the Holy See (Roman Catholic headquarters in Rome) and a like body named by the Greek Orthodox (Catholic) church in Constantinople is likely to confer soon as to the practicable use of Radio to send spiritual and other messages to all religious denominations throughout the world. This was the opinion of the Rev. George Craig Stewart of Evanston, Ill. (suburb of Chicago), on his return from a conclave in New York City which received from the League of Nations a proposal regarding the international conference.

According to the Rev. Fred Pfotenhauer of Chicago, synodical head of the Lutheran church, the first step in what may be, he said, the national use of Radio by the church is the purchase and operation of a broadcasting plant by the Lutheran theological seminary in St. Louis, Mo.

Other Denominations Consider Radio

The general promotion board, in New York City, of the Baptist church in the United States, according to the Rev. Alfred E. Peterson of Oak Park, Ill. (suburb of Chicago), one of the church's executives, recognizing the growing use of Radio not only by its own ministers but by those of other religious denominations, may soon consider its national use.

Another step toward the national use of Radio is that in which the Radio Bible

Service bureau of Cincinnati purposes to broadcast Biblical lessons daily.

The Radio Bible Service bureau was organized and is supported largely by business firms throughout the country. The Rev. Dr. Robert Watson of Boston, Mass., is president; Dr. Frank H. Stevenson of Cincinnati, vice president; Addison Y. Reid of Cincinnati, secretary; I. F. Tunison, M. D., Cincinnati, treasurer, and Arthur Wilson of Battle Creek, Mich., field secretary.

The service of the bureau is free to broadcasting stations. Of these the San Francisco Examiner, Station KUO, Memphis Commercial Appeal, Station WMC, and Louisville Courier-Journal, Station WHAS, are already enlisted. The bureau is to operate soon in Canada.

Thus, in line with one of its primal aims the church as a whole throughout the world apparently is to rely on Radio to bring permanent peace to all peoples.

Woman Diver Tells What She Found on Bed of Sea

NEWARK, N. J. — Martha Campbell Goodman, who enjoys the unique distinction of being the only woman professional deep sea diver, talked from Station WOR recently. Her broadcast was on the subject, "What I Found at the Bottom of the Sea."

The only woman deep sea diver is a wite of a person, four feet five inches tall. Although she weighs but 110 pounds, she has served on boards of directors with marine men, bankers, literary folk and organized political factions.

CONTENTS

Radio Digest, Illustrated, Volume VII, Number 12, published Chicago, Illinois, December 29, 1923. Published weekly by Radio Digest Publishing Company, 123 West Madison Street, Chicago, Illinois. Subscription rates, yearly, Five Dollars; Foreign Postage One Dollar additional; single copies Ten Cents. Entered as second-class matter at the postoffice at Chicago, Illinois, under the Act of March 3, 1879.

"All the Live News of Radio"	1 to 9
Charts and Lessons in Dancing to Accompany Arthur Murray Broadcasts.....	4
An Evening at Home with the Listener In.....	8
Neutrodyne Circuit Using Only Three Tubes, by Harry J. Marx.....	9
Two Stage R. F. and Detector, R.D.-108; Review of Books.....	10
Further Details of Miloplex Hook-Up.....	11
Advance Programs for Current Week.....	12
Simple Explanation of Radio for Everybody, Chapter VIII, Part III—Antennas and Grounds, by M. W. Thompson.....	15
Editorials; Indi-Gest; Condensed, by Dielectric.....	16
Latest Development in Grimes Inverse Duplex, Part VI—Tuned Radio and the Inverse Duplex, by David Grimes	17
Spider Web Hook-Up Similar to Miloplex.....	18
Simple and Efficient Honeycomb Coil Circuit, Part I—Kinds and Types of Coil Windings, by H. J. Marx.....	19
R. F. and A. F. with Special Transformer.....	21
Questions and Answers.....	22
Broadcasting Stations, Part IV.....	23
Radio Illustrated, a Page of Pictures.....	24

Looking Ahead

Single Tube Reflex Hook-Ups Take Home the Bacon when it comes to picking a good fool-proof circuit for the beginner to build, but C. K. Beebe tells us his tuned impedance form has them all backed off the boards. He'll tell about it next issue. And David Grimes, the inventor of inverse reflexing, concludes his interesting series on the adaptations of his circuit by giving a number of precautions.

WD-11 and WD-12 Tubes Are Fine When Used Right—but when used wrong, they won't percolate a whimper. So in R. D.-106 next issue we'll tell you a dandy circuit for the single dry cell tubes.

Regeneration—What Is It? M. W. Thompson knows, and he will tell, beginning next issue. You might as well get in on the secret. Regeneration is liable to happen most any place where you don't want it, or not happen where you do want it, so learn how to tame it!

Honeycomb Coils and Other Forms of Special Inductances will be discussed again by H. J. Marx in the first number of the New Year. Certain hook-ups lend themselves more easily to these special coils. Get the hook-ups for future reference. Yes sir, his super-heterodyne set building series is coming soon.

When We Told About Dr. A. Meisner Last Week a lot of anxious readers wanted to get an advance line on him. Well, since it takes a long time and fifty billion marks to get a letter over from Germany, Dr. Meisner's series won't begin at once. So you'll hear a lot about him for several issues yet. He's the man who invented regeneration in Germany almost at the same identical moment as did Major E. H. Armstrong in this country. You've heard and read a lot about the Major, but Dr. Meisner is worth keeping in mind. He is to Germany what Marconi is to Italy; Lodge to England; Flewelling to the United States.

Newsstands Don't Always Have One Left

WHEN YOU WANT

Radio Digest

YOU WANT IT!

BE SURE OF YOUR WEEKLY COPY BY SUBSCRIBING NOW

SEND IN THE BLANK TODAY

Publisher Radio Digest, 123 West Madison St., Chicago, Illinois.

Please find enclosed check M. O. for Five Dollars (Six, Foreign) for One Year's Subscription to Radio Digest, Illustrated.

Name

Address

City..... State.....

Carter Jack Switch

\$1.00



The best radio switch yet devised—easily mounted on panel—just like a jack—a quarter turn of the knob operates the heavy phosphor-bronze springs.



Furnished complete with "On and Off" name plate, knob and pointer.

Made in four different spring combinations. Ask your dealer.

Send for FREE wiring diagrams of various hook-ups; also complete catalog of other new improved Carter Radio Products.

Carter Radio Co.



Columbia Inside Coil Mounting

Newer, Neater, Better

Here is an inside coil mounting made for the radio owner who wishes to keep bulky coils out of sight. It is friction geared and fine "vernier" adjustments are possible. Nothing shows outside panel except knob and pointer. Only \$6.00 at all good dealers. DEALERS—Responsible distributors all have Columbia Radio products. It pays to give your customers the best. No other radio products have this name—insist on it.

Columbia Radio CORPORATION



It's Columbia—So It's Good!

Morrison



Loud Speaker --to the LUCKY ONES

YOU who received new receiving sets for Christmas naturally are eager to get the best from the wonderful broadcasting now sending from all over the country.

Morrison Loud Speaker, attached to the tone arm of your phonograph, will give you the real thrill of radio. Relaxing in your chair, you hear the chosen concert with unbelievable reality. No fussing and adjusting—Morrison has but one adjustment to make and this is from soft to loud—no distracting vibrations and harsh noises—Morrison brings it in smoothly, truly.

You'll like your new set with Morrison Loud Speaker

\$10.00

Complete with 5 foot cord Nickel Plated Model

Our new two-color folder is just out—it's yours for the asking

Morrison Laboratories, Inc. 343 Jefferson Avenue East, Detroit, Mich.

EXPOSE OF MUSIC TRUST PRINCIPLES

ADMIT CLEVERNESS OF AMERICAN SOCIETY

Patrons Paying Tribute to Organization Believe Money Going Wrong Way

(The following article is the last of a series which has been published with the express purpose of explaining to the Radio public the situation existing between the broadcasting stations and the American Society of Composers, Authors and Publishers. The series tells in detail the reasons why the National Association of Broadcasters was organized, and why certain popular songs, the copyrights for which are controlled by the "music trust," are not being broadcast.—The Editor.)

Part VII.—Conclusion

CLEVERNESS must be conceded to the management of the American Society. They have their arguments and though their logic may be twisted they make the most of what they have to do with. For instance, when they are confronted with the very pertinent argument that broadcasting does popularize their music, they very quickly dodge and say: "Thank you, but we do not ask for your help and do not want it. We will choose our own advertising mediums."

While unresponsive to the question being discussed, it is a rather adroit answer, you will admit. It ignores Judge Lynch's opinion that "broadcasting of a newly copyrighted musical composition would greatly enhance the sales."

Turn About Is Fair Play

But broadcasters send them the retort courteous: "You may choose your own advertising mediums, and we will choose our own music."

Can this attitude of the broadcasters in any manner be considered a boycott of the music of the American Society? The answer is "by no means," because the Bureau of Music Release of the National Association of Broadcasters will just as willingly release the music of the American Society as that of any others, providing that their music will pass inspection for musical merit; is of clean lyrics and that an agreement is made similar to those now in existence between copyright owners and the National Association of Broadcasters.

The success of the American Society in collecting from theaters, cafés, restaurants, cabarets, hotels, dancing academies and halls, moving picture shows, fairs, expositions, summer shows, carnivals, phonograph records, piano player rolls, street pianos and organs, and others had led them to believe that their policy must be right, and that millions more could be collected from Radio stations. Half a million yearly, you remember, was their figure.

There is fairness in all things. No situation can be permanent which is not founded upon equity. Justice endures, avarice fades. Right triumphs—wrong never.

Issue Moral—and Financial

These people who have been paying tribute to the American Society of Composers, Authors and Publishers are rebellious. They are looking for a way out, not entirely because of the tax they pay, but more particularly because of the feeling that they are being held up; that they are doing a service and if anyone pays, they are the ones who should receive. It is a moral issue as much as financial and they believe the money is going the wrong way.

And so comes the National Association of Broadcasters, well organized and furnishing new music weekly upon which no tax need be paid to anyone. The world is combed for this music. Less than three per cent of that submitted is accepted. The result is a surpassing quality of music going out weekly from the Broadcasters' offices, music of a quality declared by prominent orchestra leaders to be fully equal, and in many respects superior, to that which the American Society puts out.

WJY FINISHES TESTS AND SPEAKS AGAIN

NEW YORK.—After a period of silence during which research and experimental work has been in progress, WJY, the twin station of WJZ, at the Radio Corporation of America's dual broadcasting station located in the Aeolian Building here, has resumed broadcasting during its former periods on Tuesdays, Thursdays, Fridays and Sundays. The old wave of 405 meters is used.

JACK TELLS OF HIS EARLY DAYS IN RING

NEW YORK.—Jack Dempsey, heavyweight champion of the world, spoke from Station WHN, Loew's State Theater here recently, making his Radio debut. Dempsey has just arrived from California where he has been resting and offered an interesting talk on his early career as a boxer and vicissitudes of a boxer's life. Dempsey said that he had frequently listened in to WIIN.

GIVES VOICE TO MOTION PICTURES



Perfect synchronization of sound and motion so as to supply the missing link of speech between the screen actor and the movie fan was promised not long ago by Dr. Lee De Forest as a development of the near future and is now ready for demonstration before the public. Here is seen Mrs. De Forest singing before the microphone while her motions are recorded by the movie camera K. & H. Photo

Meet American Society on Own Ground

This is the first attempt ever made to meet the American Society on their own ground—not by haggling over what rights they may or may not have legally, but by meeting them squarely on the moral issue involved: that they profit greatly through the advertising given them and that if anyone is to pay, it should be the members of the American Society.

Very few Radio stations have been impressed by the claims of the American Society. The low-priced licenses offered (from \$200 to \$5,000 annually) are recognized as honey to catch the fly. Just a fairly good beginning.

If there were no association of broadcasters to stand between the American Society and broadcasting stations, there

would be an expensive bill to be paid by someone, and not more than one guess is needed as to who this "someone" would be. (THE END.)

Sunday Night Concerts Again on Air from WJY

NEW YORK.—The Sunday evening concerts by the Waldorf-Astoria Symphonic Orchestra, of which Joseph Knecht is director, have been resumed as a regular Sunday evening feature from Station WJY here. The orchestra is one of the best known in the country. There are thirty-five musicians and Joseph Knecht, the conductor, was formerly assistant director of the Metropolitan Opera.

TALKING PICTURES READY FOR PUBLIC

GET GOOD RECEPTION IN NEW YORK

"Sprung" on "Cold" Audience, Undergoes Ordinary Stage Tests

NEW YORK.—Dr. Lee De Forest's phonofilm which was demonstrated last Spring when the inventor of the three element vacuum tube gave a demonstration before the New York Engineering Societies, is now ready to be shown to the public.

At the first showing Dr. De Forest received congratulations from scientists all over the country on his accomplishment of synchronizing sound and picture on a motion picture film—a problem that had baffled experimenters for many years. It was admitted at the time that while the demonstration was satisfactory from a scientific point of view, the phonofilm needed refinement before it could be generally introduced to the public.

Make Refinements in Device

Dr. De Forest has worked day and night to get the film to the point where it would be acceptable to theater audiences. Experiments were continually carried on at the De Forest studios here, where a corps of technicians labored side by side with theatrical advisors.

Satisfactory scientific results were obtained about two months ago and then the theatrical angle was taken up in earnest.

Within the last month, the phonofilm was given the same sort of severe test that all new vaudeville acts undergo. It was installed in the Coliseum Theater here, and it was "sprung" on the audience "cold" just as a new act is given a try-out.

How Phonofilms Are Made

The response on the part of the audience was very encouraging.

It is easy to visualize the relation of the phonofilm to Radio if one has ever been in a broadcasting station. There the speaker or the singer speaks into the microphone and the words or music are taken up and launched upon the ether to be again picked up by countless receiving stations scattered far and wide. In the case of the phonofilm, however, the microphone catches the actor's voice or the music from the orchestra in a similar manner, but instead of sending these tones out upon the ether, they are photographed onto standard negative motion picture film.

WLAG TO BE CENTRAL CALIBRATING STATION

Chosen by Standards Bureau for Power and Location

MINNEAPOLIS, MINN.—Ray A. Sweet, chief engineer of WLAG, the Twin City (Minneapolis and St. Paul) Radio Central, operated by the Cutting & Washington Radio Corp., has been notified that WLAG has been selected by the U. S. Bureau of Standards as the bureau's "central" calibrating station.

WLAG was chosen as the result of a series of tests because of its power, central location and capability of being heard on both the Pacific and Atlantic coasts consistently. The government started the calibrating work December 7, broadcasting standard signals all over the country so the 700 or more sending and hundreds of thousands of receiving stations may tune their wave lengths.

The eastern station designated by the bureau to calibrate is KDKA, at East Pittsburgh, which broadcasts to the Pacific coast with the aid of its relay station KFKX, at Hastings, Neb.

Broadcast "Sampler" Plays

TROY, N. Y.—At the invitation of Station WHAZ, Rensselaer Polytechnic Institute in this city, the Masque of Troy, a prominent local Little Theater organization, recently broadcast a "sampler" production, including four one-act plays.

THE ANTENNA BROTHERS

Spir L. and Lew P.

Tuning in Station 1924

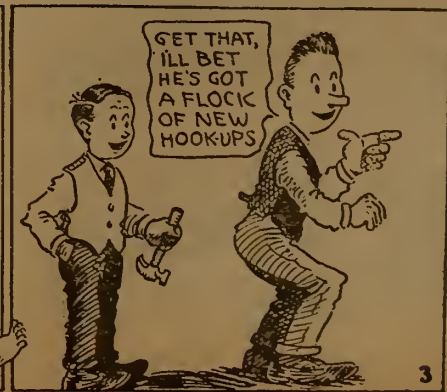
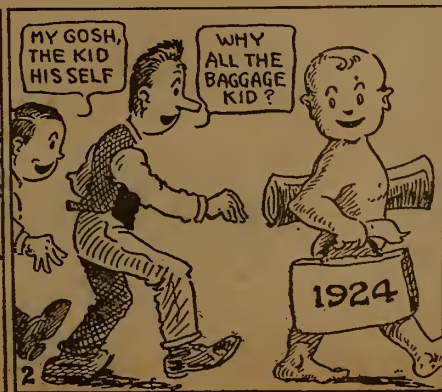

GIVE LESSON FOUR OF MURRAY SERIES

REPEAT CHARTS FOR ENTHUSIASTIC RADIOPHANS

Instructions Republished to Meet Demand from Listeners Who Missed First of Series

Learn to dance by listening in! Radio Digest has perfected an arrangement with Arthur Murray, nationally known teacher of ballroom dancing, whereby Mr. Murray is broadcasting dancing lessons from WOR, L. Bamberger and Company, Newark, N. J., and a score of other prominent stations. Radio Digest exclusively is giving the charts and instructions which apply to the lessons broadcast by Mr. Murray at WOR and by the other stations. WOC, WRAP, WNAC, WLW, WLAG, WRW, WHAS, WFL, KPO, CFCF, WSAD, WTAS, WGY, WMC, KDKA, WRC, WGI, WCAE, WHAM, WBZ, WGR, and KYW are broadcasting the series. The complete course occupies six lessons, one of which will be given each week. Save the lessons to use with the broadcasts.—The Editor.

Lesson IV—The Two-Step By Arthur Murray

REMEMBER that a Two-Step is simply two sliding steps. Beginning with the left foot, slide sideways two steps with the left foot. This you count: 1. Slide left foot directly to left; 2. Draw up right foot; 3. Slide left foot to left, weight on left. (Take right foot slightly off the floor.) This completes a Two-Step to the right. See Figure 5.

THE TWO-STEP TO LEFT

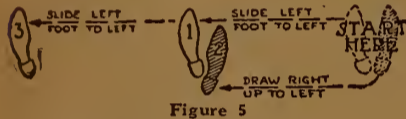

The second part, two slides to right, is taken with the right foot:

1. Slide right foot to right; 2. Draw up left foot to right; 3. Slide right foot to right, weight on right. (Take left foot off the floor.) This completes a Two-Step to the right. See Figure 6.

DON'TS FOR DANCERS

By Arthur Murray

Don't take short steps; they are not only ungraceful, but betray a lack of confidence.

When a man wants to be sure of stepping on his partner's feet, he starts with his right foot. Moral: start the dance with the left foot.

Don't cry about it. Dancing is supposed to be an expression of joy. The funereal expressions on the faces of some of our brethren certainly contradict that assumption.

To repeat, begin with the left foot and do the first part. Practice two slides to

THE TWO-STEP TO RIGHT



Figure 6

the left and two slides to right for thirty minutes.

(TO BE CONTINUED.)

Listens In with His Set of Tin Dishpans

Minneapolis Expert Evolves "Cascade" Principle

MINNEAPOLIS.—Using an ordinary tin dishpan for an antenna and another like it for a counterpoise, Bowden Washington, Minneapolis Radio engineer, is hearing broadcasting stations all over the United States, according to announcements made recently.

The set is reported to be operated on a new principle of cascade regeneration worked out by Mr. Washington in two and a half years of laboratory experimentation.

It uses four UV-199 tubes. On a test with a six foot steel fishing rod as antenna, stuck between the cushions of a touring car, the signals of WLAG, Twin City Radio Central here, were copied for several hundred yards while the car was in motion twenty to thirty miles away.

All the British lightships will be connected with the home office by Radio telephone.



For the Living Room—

Unsightly wires and acid-filled storage batteries are unnecessary with

The New GREBE Broadcast Receiver



Here is an Instrument whose beauty adds charm to any room. The rich walnut cabinet has compartments for all necessary batteries. Ask your Dealer.

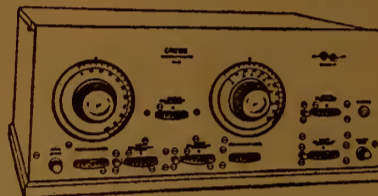

Licensed under Armstrong U. S. Pat. No. 1113149

A. H. GREBE & CO., Inc.
Richmond Hill, N. Y.

Western Branch—451 East 3rd St., Los Angeles, Cal.



You will marvel and be thrilled by the performance of Federal Radio Parts

Ideal Gifts

Groups of Federal Radio Parts to make complete set

Federal Standard RADIO Products

THE De Forest name has been in the forefront of radio research for twenty-three years. De Forest invented the three-electrode vacuum tube which makes present-day radio possible. The sets and parts made today by the De Forest Company are worthy of the De Forest name.

DE FOREST RADIO TEL. & TEL. CO.
Dept. R. D. 4 JERSEY CITY, N. J.



JOE LAURIE TELLS HIMSELF OF RADIO

FAMOUS COMEDIAN GIVES SELF INTERVIEW

"Radio, and What of It?" His Topic—"Gingham Girl" Laugh-Producer Tells about Broadcasts

By Joe Laurie, Jr.

In the not distant past when Mr. Laurie played in vaudeville I had an occasion to interview him—I think it was about a bill—and I found him dressing in a room in the basement of the theater. At another time I had to climb so many steps that when I finally reached his floor I forgot whom I came to see—but now—it is different. Here he was dressing right on the stage—and it was news to me to find that he was one of the proprietors of the show—there it was, a big sign outside of his dressing room door—PROPS. I was glad to see this youngster getting along so nicely. I always liked him. Joe Laurie, Jr., always impressed me as a decent sort of a chap. He is small in stature, about five feet standing or sitting, has a very pleasing personality in spite of it—big brown eyes and large cigars—and a vaudeville heart. I started with—

Reporter.—"My dear Mr. Laurie, or may I call you Joe?"

Actor.—"If you ever call me Mr. Laurie I'd think you were sarcastic."

R.—"Thanks. I want to ask you if—"

A.—(Interrupting.) "Certainly help yourself—and don't be afraid of it. It's good. I made it myself."

R.—"No thanks. I mean I won't be afraid of it. My gosh, you almost had me saying no. It's so seldom I am offered this stuff free."

A.—"You have a good nose for news, a good taste for liquor and large generous ears. You have every qualification to be a genius."

R.—"Please let's not discuss my past. I came here to interview you about Radio. I want you to tell me what you think of Radio, its programs, its relation to the stage and the artists, its future, and what your experiences were when you first broadcast. Just tell it to me in your own crude, ordinary way and I will tune it up for you. Remember this interview may go through the mails so act accordingly. Don't be offended if I act bored. This is my business; I get paid for it."

Mr. Laurie Tells Why He Broadcast

A.—"Well Mr. Laurie I'll start at the beginning. That's the usual procedure, isn't it? And end up by telling you the finish. Mr. Hertzman, the manager of the Gingham Girl Co., the show I am appearing in, matinees Wednesdays and Saturdays, asked me one afternoon if I would broadcast some of my monologue that I did in vaudeville, that it would be a good stunt for the show—get publicity for myself, etc., etc. Well, I never did broadcast before, and I was anxious to see what it was all about. But a star must never be too anxious, (must not show it to his manager anyway), so I acted sort of star-ish. I can do that sort of stuff. I was an office boy in a dentist's office once. And I hemmed and hawed a YES to him."

What a Microphone Is

"So he arranged for me to appear at a studio in Chicago. In the center of the room was a stand with an instrument on it that looked a lot like a motor meter, only it didn't have the personality. The instrument is called a MICROPHONE. It is the

JOE LAURIE, JR., INTERVIEWS JOE LAURIE, JR.



Joe Laurie, above, is telling Westinghouse Station KYW listeners how he caught a fish by telling him one of his "Gingham Girl" jokes. The fish (note length) laughed himself to death, getting a pain in the gills. At right, the photographer caught Joe as he appears in the show

connecting link 'tween your larynx and the Radio Public. It's through this little instrument you TELL THE WORLD.

"The place was empty except for my manager and the announcer. The juice was turned on and the Radio public were informed that America's Greatest Comedian would make a few alleged comic remarks. I knew at once he meant me, so I pointed myself at the microphone and started.

"Can you imagine trying to be funny in an empty room? I started fast—not being funny—speaking. I passed some of my best wows and not a ripple. I went faster—got scared. Can you imagine a swell actor like me spilling nifties one after another and not a ripple of applause, not a laugh, not even a snicker?"

Prays Radio Booking Office Radio Is Out

"I made a mental prayer that the booking office Radio wasn't working. I knew if it was I wouldn't be. Here was I who have played houses where they had to strap the customers to the seats for fear I would knock them off with my merry sayings, happy quips and rebuilt jokes—FLOPPING—and over the Radio, and me dressed so nice for the occasion.

"Well the perspiration was rolling up my brow, yes UP. I had my head away back—and this is strictly between ourselves—for the first time in my life I HAD STAGE FRIGHT, and the funny part of it all was I wasn't on a stage. Well, maybe I got no applause, but then again I got no censure. I took a couple of bows through force of habit and my first experience with Italy's greatest invention outside of spaghetti, was over. Gee, I felt worse than

production of Auld Lang Syne was played and Mr. Laurie went into the following—

His Second Adventure with "Mike"

A.—"The next time I touched my public was through the KYW studio in Chicago. I arrived at the studio and found an audience of over fifty ladies and gentlemen. A friendly spirit permeated the air. Still there was dignity enough to give it the proper atmosphere. They all were seated facing the artist who was broadcasting. I was announced and I stepped up for my second introduction to the deadly microphone, but this time it was so different.

"I just looked at my little audience. I am used to looking at small audiences. (I played Baton Rouge once.) I did my stuff, sang a couple of songs from the show, and pulled a few wise cracks which were greeted with laughter from the audience and made me feel fine. I did about twenty minutes, and finished to hearing applause, so different than my first experience. The studio received telephone calls and wires from all over the country asking me to repeat in the near future.

Joe, the Announcer

"I did. A week later I acted as announcer for KYW. I have received many hundreds of letters since from all over the United States, and one from Brooklyn, saying that they hoped to have an opportunity of seeing me in person. So you see it pays to lead a simple, honest life. Of course, not too simple and not too honest. Now Joe, I wish you would reach down on the floor and pick up that word resumé. It's one of the words a dramatic critic dropped while visiting me here the other night. I don't know what the word means but I will take a chance on it as he certainly knows how to put words together. So here is my resumé.

Resumé of Joe's Idea of Radio

"That the studios will get better results from the artists if they have audiences there to listen to them.

"That the announcers should put comedy into their announcements, and get more intimate with the Radiophans. They like it.

"That managers of shows and broadcasting stations should get together. They will both gain by it.

"That the actor can reach more people through Radio than he could ever hope to meet otherwise—future customers. The actor's drawing power isn't hurt a bit. I have many friends who have Radio sets that work, and they tell me that hearing the artist on the headset makes them anxious to see the show. Meet him not via the ears, but the eyes.

"That the studios should have more variety to their programs. Too many violin, soprano and piano solos. Pay the artists if you have to, but get variety, with plenty of COMEDY.

"In conclusion, REMEMBER—
"BROADCAST UPON THE WATERS WILL BE RETURNED AN HUNDRED FOLD TO YOU IN PUBLICITY."



a week in Baton Rouge. Please pass me that bottle of Witch Hazel. Thanks." It was several hours later when the reporter and the actor came too. An in-

Thrills from Radio

No. 9 of a Series Featuring Experiences of "ALL-AMERICAN" Users

TRIED MANY—ALL-AMERICAN BEST

By Frank Sasek, New York City

"I have had very good results that mean real thrills. They are the best known, most widely used transformers on the market. Standard equipment on the better sets. Why experiment? Over 500,000 radio enthusiasts, like Mr. Sasek, have already proved "All-Americans" best.

"After trying many different makes, I was best satisfied with yours."

Without distortion, "All-Americans" bring in distant and nearby stations with volume and tone-quality



All-American Audio Frequency Transformers come in three ratios: 3:1, 5:1, 10:1.

All the better dealers sell "ALL-AMERICAN"

RAULAND MFG. CO., 200 N. Jefferson St., CHICAGO PIONEERS IN THE INDUSTRY

AUDIO AND RADIO FREQUENCY

POWER AMPLIFYING INPUT AND OUTPUT



ALL-AMERICAN AMPLIFYING TRANSFORMERS

Largest Selling Transformers in the World

Coto

"Built First to Last"

New Coto Compact Moulded Variocoupler

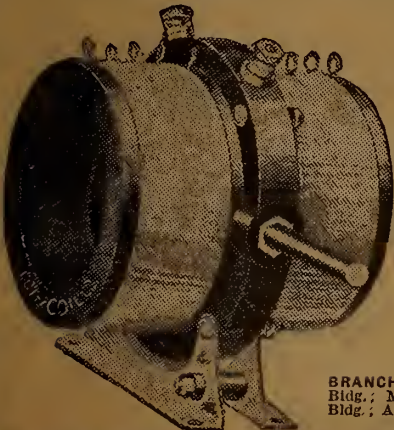

Size is only 3/4x3x3/4. (Variometer to match 3/4x1 1/4x3/4.) Just what you have been looking for to make a beautiful, efficient and portable set. Eight taps for use with primary condenser. Pigtail connection to rotor. Range 200 to 600 meters. Type 9000.....\$5.50

If your Dealer fails you write us at Once.

COTO-COIL CO.

87 Willard Ave., Providence, R. I.

BRANCH OFFICES: Los Angeles, 329 Union League Bldg.; Minneapolis, Geo. F. Darling, 705 Plymouth Bldg.; Atlanta, C. P. Atkinson, Atlanta Tr. Co. Bldg.

MARCONI PREDICTS RADIO UPHEAVAL

INVENTOR SEES AIR WAVE GUIDED TO RECEIVER

Recent Tests in London May Enable Crystal Sets to Hear Cross-Sea Signals

LONDON.—Even the wildest dreams of Radiophans throughout the world may soon become real if the plans of Senatore Guglielmo Marconi, noted Radio inventor, based on recent experiments, are successfully developed. The Italian-American whose devices largely have made Radio communication practicable has completed a series of experiments here which he said will revolutionize present methods of long-distance transmission.

Instead of projecting or impelling electromagnetic waves without direction or destination, Marconi declared at a meeting of the Wireless Telegraph company over which he presided, that his proposed apparatus will be propagated and guided in the form of a beam which may be turned to any direction.

Crystal Sets May Hear London

The inventor asserted that he and C. S. Franklin, co-experimenter, had recently communicated with St. Vincent on one of the Cape Verde islands, 2,250 nautical miles from England, by means of the new system. The electrical energy required for the directed transmission was much less, Marconi said, than that otherwise employed.

Marconi also reported that his recent experiments led him to believe that owners of crystal sets in the United States would soon be enabled to receive messages broadcast from London. This, he said, was because all the power would be sent in one direction, thus intensifying the signals in receivers lying within that beam.

Canada Hears Frisco Organ

SAN FRANCISCO.—Way up in Canada, in the town of Nipawin, twenty-five miles from a railway, 100 miles east of Prince Albert, a listener in heard Station KPO (Hale Brothers) here broadcast an organ recital clearly. The listener in, manager of a branch bank, wrote his appreciation to Ada Morgan O'Brien, director of the station.

UNCLE SAM BUILDS BARGAIN RECEIVER



A crystal receiver for sixty cents! That is the claim of the inventor and designer, John P. Brickley of the U. S. Bureau of Standards. The set consists of two pieces of fiberboard with eight and ten turns of wire for secondary and primary, respectively. (Note: Write Mr. Brickley for further details.)
Fotograms Photo

South American "Bugs" Talk

VALPARAISO, CHILE.—Another step was taken recently in the development of Radiophony here when for the first time a conversation was held between a private broadcasting station, belonging to a Chilean amateur in Vina del Mar, on the Pacific Coast, and Tucuman, Argentina. The Vina del Mar station was distinctly heard in a Radio club in the latter city at midnight, whereupon conversation was kept up for over an hour.

RADIO TALKS

One would not expect split second time keeping qualities from a poor alarm clock and those of us who have been through the battle with Radio have learned not to expect maximum results from poor Radio apparatus.

E. J. Flewelling

E. J. Flewelling Tuner

Designed to meet the requirements for a tuner embracing simplicity, neatness and efficiency, the Flewelling Tuner is the utmost in Radio perfection. Made of heavy sheet bakelite and nickel parts (no wood or fibre is used in the entire construction). Has no loss producing taps or unsightly leads; no solid dielectrics in coil field, all bearings and parts substantially and accurately made. But a single panel hole is required for mounting. Tuning is controlled by one dial and reduced to one condenser setting and adjustment of tuner to maximum volume, in the usual single circuit hook-up. Coils are firmly held in place by thumb screws and are easily removed and replaced. However, a wide wave band can be reached without coil change. This tuner is exceptionally efficient when used in the Flewelling super circuit.

BUELL MANUFACTURING COMPANY

2977 COTTAGE GROVE AVE.
CHICAGO

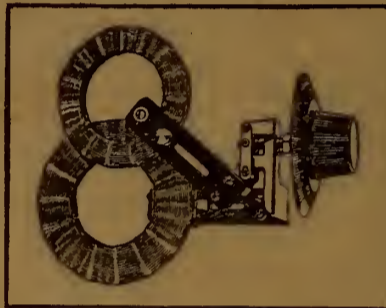

\$ **8.00**
At your dealers or post paid.

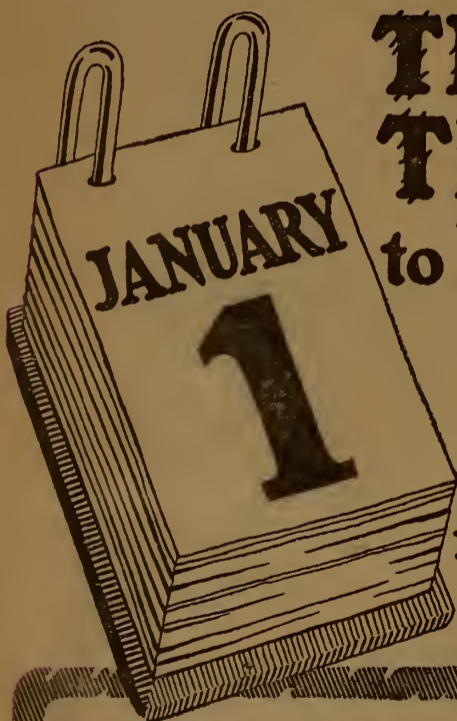

THIS IS THE DAY to Purchase a

NATIONAL
MONODYNE
TRADE MARK
TUBE SET
MODEL GT-1

for a full year's entertainment

Radio during 1924 will give the public the greatest source of education and entertainment.

You cannot afford to deprive yourself and family of this golden opportunity. So wonderful is broadcasting today that millions listen-in to educational and religious lectures, political speeches, market reports, sporting events, concerts and orchestras.

The Monodyne Single Tube Set brings all these entertainments right in your home free of cost.

LOW PRICE
ONLY ONE TUBE
ONE TUNING CONTROL
SIMPLE AND EASY TO OPERATE
EXCEPTIONAL VOLUME AND CLARITY
LOCAL AND DX RECEPTION
Perfect Selectivity—No Distortion
Dealers and Jobbers—Write for Sample and Prices



\$10 Without Tube

NATIONAL
AIRPHONE
CORPORATION
REG. U. S. PAT. OFF.
16-22 HUDSON STREET
NEW YORK

CLEAR AND SWEET—

You've tried many expensive tricks to improve reception on that set of yours, but do you know that for the cost of one necktie you can get real results?

THE ORIGINAL COMSCO



AUTOMATIC

BULL DOG GRIP PLUG



(Licensed under Pat. Pend. Serial No. D 8010—No. 578540)

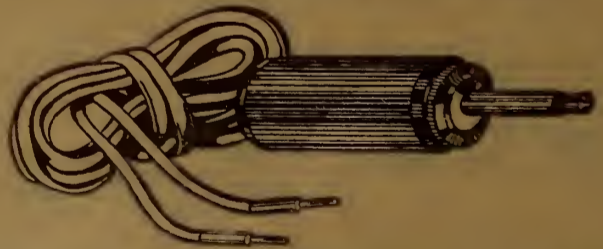

IS THE LAST LINK IN PERFECT RECEPTION

Simple to Operate
Insert connecting tips by a single touch. Release by pressing a small knob and the tips slide out easily without pulling the electrical contacts.



For one pair phones \$1.00
For two pair phones \$1.50

Bull Dog Grip
The COMSCO AUTOMATIC BULL DOG GRIP PLUG saves you from short circuits and battery kicks. No more burned-out phones or ruined transformers. No more broken finger nails.

FOR SALE AT YOUR DEALER

Otherwise send purchase price direct to us and you will be supplied

GENERAL INSTRUMENT CORP.



123 Liberty Street
NEW YORK CITY



Performance of WDAP and WBAH Gives Impetus to Power Amplifier Station

Co-Designer of Far-Reaching Chicago Plant Tells Secret of Great Success—Drake Hotel Outfit and Minneapolis Transmitter Heard Regularly in England

By J. Elliott Jenkins, Executive Engineer for Station WDAP, Board of Trade, Chicago

OWING to developments during the trans-Atlantic broadcasts, I think the time is about ripe to publish a few facts concerning the design of the transmitter at Station WDAP, of the Chicago Board of Trade. It has been generally known by those interested in Radio-telephone transmission that this outfit is not of the usual type, a Hartley or Colpitts oscillator with plate modulation, but some curious freak vaguely known as a power amplifier. The hook-up of WDAP has never been guarded as a dark mystery, but on the other hand, little has been published about it.

WDAP is indeed a power amplifier, which, after all, is a very simple affair. It is much like a Radio frequency receiving set. Here you have a very slight modulated oscillation set up in a coil which is coupled to an antenna or loop. You tune this coil to resonance and let it feed into the grid of a vacuum tube. The plate of this tube is run through the primary of a transformer to the B batteries. The secondary of this transformer, often tuned by a condenser, goes to the grid and filament of the next tube. So far WDAP is about like a receiving set. But the output of this tube, instead of going to a detector, goes into the big transmitting antenna.

100-Watt Set Now Amplified

Here it is. Two fifty-watt tubes in parallel are connected in the Hartley oscillator hook-up, so familiar to the "ham." Two similar tubes impress the voice currents on the plates of these oscillators—the well-known "constant current system" of modulation. Most every "ham" phone set in the country is built on this order. It is easy to build and get going, and is very stable. The inductance of this circuit is the familiar helix of flat copper ribbon, about seven inches in diameter and a foot long. It has a large variable condenser across it to tune it to the exact wave length required.

So far we have a simple 100-watt phone set, without an antenna. About a foot from this inductance, and in line with it,

stands a similar helix of the same size. This is the secondary of the Radio frequency transformer, as in the receiving set. But remember that the coupling is

the filaments. The plates of these tubes get about 2,500 volts from the generators, and are hooked into the antenna inductance through a stopping condenser. This antenna inductance is in the form of a big variometer of copper tubing, which makes the circuit easy to tune or change wave length.

Big Tubes Strengthen Twenty-Two Times
Here is what happens. The output of the 100-watt set is of course a modulated oscillation. Instead of going out on the air, it strikes the grids of the big tubes. They amplify it about twenty-two times and let the result into the antenna. Owing to the loose coupling of the driver circuit, you have a very pure carrier wave and

PARIS USES 6 FOOT WAVE WITH SUCCESS

PARIS.—As a result of his recent experiments here, General Gustav Ferrle, director of Station FL, Eiffel Tower, has obtained excellent results over a distance of two miles using only six-foot wave lengths. According to Mr. Ferrle, the antenna current employed did not exceed thirty milliamperes. The low wave lengths were very free from static disturbances.

side bands, and local listeners have little difficulty tuning the station out, unless they have poor apparatus or are in the actual field of the antenna.

I would like to tell a little of what WDAP has done by way of distance, not for the sake of blowing my own horn, but in behalf of the circuit which I would like to see generally used for broadcasting. For the last two months the station has been radiating only 6½ amperes. There are five letters from England, two from the Hawaiian Islands, one from Rio de Janeiro, and numerous reports from the Panama zone and from near the North Pole. Last week an English gentleman, a Mr. Hamblett Hardlane, living near Liverpool, rose to the point of sending us two prepaid cablegrams, having heard two entire concerts. And now the last, Station WBAH, of the Dayton Co., Minneapolis, was heard the best of all American stations in the trans-Atlantic tests on Monday night, November 26. WBAH was radiating ten amperes into a small antenna surrounded by steel buildings, water tanks and electric signs, but it is a power amplifier of exactly the same type as WDAP.

That is all I want to say. My partner, Thorne Donnelly, and I have worked very hard over this power amplifier circuit, and I think its recent performances make it deserving of the attention of those interested in voice transmission.

Broadcast on Bible

BIRMINGHAM, ALA.—Alabama College at Montevallo, Ala., is the only college in the South broadcasting lectures on the Bible. These lectures are delivered by Rev. P. H. Carmichael.

TRIS OF "INDIANS" LOVES MIKE



Of course you recognize this gentleman as Tris Speaker, the redoubtable manager of the Cleveland "Indians." This photograph was posed especially for Radio Digest, in the studio of WJAX, the broadcasting station of the Union Trust Company, Cleveland, Ohio. Tris is a Radiophan of most ardent type, as may be seen from the affectionate smile he is bestowing on friend "Mike"

very loose—a foot or so. This secondary is also tuned by a variable condenser, easily accessible to the operator. One end of this coil goes right to the grids of eight 250-watt tubes, all in parallel. The other end runs through a storage C battery to

UV-200



"The detector tube supreme." Noted for stability, long life, and uniformity. A six-volt standard base tube for any receiving circuit.

Radiotron UV-200 with its long distance reception—clearness—and good volume—is the basis of many a receiver's splendid performance.

Radio Corporation of America

Sales Offices—Dept. 3002
253 Broadway, New York
10 South LaSalle St., Chicago, Ill.
433 California St., San Francisco, Cal.

Price
\$5.00

Be sure that every vacuum tube you buy is marked **RADIOTRON**



This Symbol of quality is your protection

Radiotrons

REG. U. S. PAT. OFF.

RADECO SAFETY FUSES

(Patented)

Now available for **DEALERS' SALE**

Radio users have learned that *Radeco Safety Fuses* are a necessary tube protection—that their price (50 cents) is small compared with the great service they render.

The merit of the fuses, their low price and our extensive advertising have created a ready sale.

Up to now these fuses have been sold direct by mail, but the demand is so great that we want to distribute them in larger units through the trade channels. You will find *Radeco Fuses* a profitable item to add to your stock.

To assist you in handling them, we have made up attractive display boxes in colors containing an assortment of two dozen fuses.

Price per box (2 dozen fuses)
\$12.00

Subject to Regular Trade Discounts
ORDER TODAY



Radio Fans! *Radeco Fuses* can now be purchased at your Dealers.

RADIO EQUIPMENT COMPANY

New England's Oldest Exclusive Radio House

20 STUART STREET

BOSTON, MASS.

THE

TRADE MARK
AUDIOPHONE
REG. U. S. PAT. OFFICE

Quality of reproduction such as only the original itself can equal. Speech that is so distinct that the voice heard is the actual voice of the speaker. Music that requires no tolerant imagination to be recognized as music of the finest type.



Bristol's Single Stage Power Amplifier



gives additional VOLUME with any two stage amplifier. No C batteries required. It provides the additional volume necessary to bring in very distant stations on the loud speaker.

Write for bulletin and address of the nearest dealer handling our instruments

THE BRISTOL COMPANY
WATERBURY, CONN.

Boston New York Philadelphia Pittsburgh Detroit Chicago St. Louis San Francisco

AN EVENING AT HOME WITH THE LISTENER IN

(SEE INSTRUCTIONS FOR USE BELOW)

Table with columns for Station and City, Met, Monday, Tuesday, Wednesday, Thursday, Friday, Saturday, Sunday. Lists various radio stations and their broadcast times.

Instructions for Use.—All the hours above are given in Central Standard Time. If your city uses Eastern Time, add one hour to each of the periods stated; if your city uses Mountain Time, subtract one hour; if your city uses Pacific Time, subtract two hours.

Complete Parts for Miloplex Circuit—Cabinet Free. List of components and prices including variable condensers, potentiometers, and sockets.

Our Price Only \$28.50. Complete Parts for One Tube Reflex. SPECIAL PRICE ITEMS. Includes Radiometer, Tricoil Transformer, and various sockets.

Complete Parts RD 99 Long Distance Receiving Set. Includes Bakelite Base Sockets, Rheostats, and Transformers.

NEUTRODYNE. This is your opportunity to secure the parts for this famous set at a decided reduction in price. Includes variable condenser and potentiometer.

Crystal Set Complete. With Phones, Aerial Lead-in Wire, Insulators. An attractive Christmas Gift. Price, complete \$8.50.

CABINETS. 9x14x8, mahogany finish. 7x9x8, mahogany finish. 7x21x8, mahogany finish. MUST SEND POSTAGE.

RADIO AT N.Y. PRICES. Daily Parcel Post. The Prices Quoted Below Deliver Goods to Your Door. Includes Loop Aerial, Dietzen Tube, Cockaday Circuit Complete, and various accessories.

THE RADIO SCOUT. "ALL WAVE" ALL CIRCUIT Receiving Set. \$21.00 Without Accessories. NOT A NEW CIRCUIT—BUT All circuits in one case. THE GENUINE CAPITOL "ALL WAVE" COUPLER SPECIAL.

Models ESTABLISHED 1923. 71 Cortlandt Street NEW YORK, N. Y. America's Greatest Radio Mail Order House ELEVEN NEW YORK STORES

Neutrodyne Circuit Using Only Three Tubes

Balanced with Compensating Condensers

By Harry J. Marx

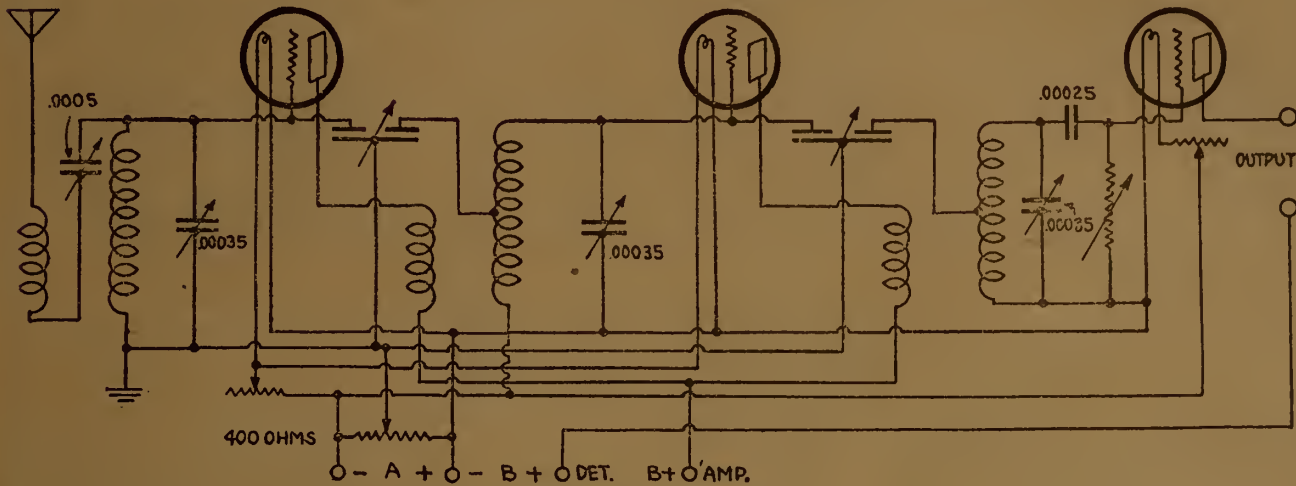

MANY fans felt that the five-tube Neutrodyne was too large a proposition to start in with, or they possessed an audio frequency amplifier unit which could be used with any detector outfit and therefore did not require the

additional audio frequency stages. To meet the requirements of these fans and also to illustrate the use of the compensating condenser method of neutralization, the three-tube circuit shown in the illustration is presented.

Tuning Unit

The standard neutroformer is used in the initial tuning unit, but is hooked up in a manner slightly varying from the usual procedure. The primary winding of the air core transformer, the .0005 vari-

able condenser and the secondary winding are all connected in series as shown. In this way all of them make up the primary circuit which is tuned by the variable condenser between the windings, while the secondary consists merely of the secondary winding of the transformer or neutroformer with its .00035 condenser shunted across it. This method of hooking up the tuning unit was found slightly more efficient than the old method.

The neutroformers consist of the standard neutrodyne air core transformers with the single tap secondary used in conjunction with the regular .00035 condenser. The special compensating condenser consists of the two separate fixed plates and one rotating plate. A 400-ohm potentiometer is used for the grid potential control on the first tube, and a variable grid leak is used for proper adjustment of the grid of the detector tube. If desired, audio frequency amplification can be added as in standard practice. About 22½ volts are required on the plate circuit of the detector tube if the UV-200 or C-300 type are used; with A tubes about 45 volts are necessary. The amplifier plate voltage should be about 90. Only two rheostats are necessary, one for the two audio frequency tubes and one for the detector stage.

What Is a Good Condenser?

How to Buy and Test Your Own

By E. T. Flewelling

WE HAVE received a great many inquiries from fans in regard to our repeated advice to use only the highest grade of apparatus in our Radio sets. Many have asked how they can tell when they have a real good variable condenser, because there are so many different types on the market that one is bewildered as to which is the best.

The easiest and quickest way for one to find the answer to such a question is to look for the name or trade-mark of the good reliable manufacturer, of which there are many, and dig deep if necessary. This really is a good way of saving money, because it means better satisfaction.

Advantages of Test Laboratory

In the electrical industry almost everything is passed upon by a disinterested testing laboratory maintained by the National Board of Underwriters. This laboratory is only interested in finding out whether or not a certain piece of apparatus comes up to a certain mark of quality, but it is also a guarantee to the public that an article approved by the laboratory is reliable merchandise. This also works out well for the manufacturer, because the tests soon tell him how he can improve his article.

The establishment and maintenance of such testing laboratories has resulted in a very high grade of electrical materials, and it occurs to the writer that it might prove to be of great value to the Radio industry if it, too, had such a laboratory. Perhaps it will in time. Radio is still somewhat of a baby.

It is the purpose of this article, however, to show how we may tell whether or not we are using a good condenser, and the following is offered as one means that is available to most anyone.

How to Test Apparatus Oneself

In a regenerative circuit we know that as we increase regeneration by moving the tickler coil, we are cutting down the resistance in the circuit. It is possible to increase regeneration to the point where the resistance of the circuit is zero or where the set "spills over." As long as this is true it is self-evident that, everything else being unchanged we will have

to increase the regeneration if we increase the resistance of the circuit. Tune in a long distance station, then, and note the reading of the dial of the plate coil. Insert somewhere in the circuit—say, between the antenna and the antenna post of your set—a light bulb or an electric iron. Now retune your set for the same station and read again the tickler coil dial. It will be found this time that it is necessary to use closer coupling of the plate coil, or in other words more regeneration to overcome the resistance of the lamp or the flat iron. Regeneration is then, roughly speaking, capable of being used as a means of measuring the resistance of various parts of our set, but owing to various other factors is better suited, perhaps, to be used as a convenient means of comparing the relative efficiencies of the tuning condensers that we might be lucky enough to call our own or to borrow.

It must not be assumed, however, that the use of regeneration to overcome resistance will make it possible to neglect the resistance in the circuit used. Add a bit of resistance to your grid circuit, and your audibility will suffer for it. The more resistance in the grid circuit (the plate circuit does not matter), the less the audibility every time, but it will take increased regeneration to bring out the maximum audibility with the added resistance. On a 180° dial the difference in reading might be extremely small but can be noted if carefully watched for.

A Concrete Example

If, for example, we have four variable condensers and are curious as to which one we will use for that new Radio frequency or reflex set that we are going to build and which is not going to use any

regeneration at all if we can help it, a single-circuit regenerative receiver is the simplest for our test. So, using such a set, we do our tuning with one of the four variable condensers. Pick out and tune in a moderately distant station as sharply as you can and take note of the reading on the plate coil dial.

The next thing to do is to substitute, in turn, each of the variable condensers that we are testing for the one first used and take the reading of the dial. It is necessary to use exactly the same leads or connections for each condenser, and keep everything in the circuit exactly the same for each condenser and also to tune

in as sharply as possible for each condenser, the same moderately distant station. If we use a nearby station, we will not be able to tune sharply enough and if the station is too distant we will have too much trouble picking it up.

Dial Tells Best Condenser

Suppose then that with our four condensers, the plate coil dial gave us a reading of 10° with one condenser, 12° with another, and so on; then we know, with a fair degree of accuracy, which is the best condenser of the lot, because it will be the one that gave us the lowest reading on the dial, or, in other words, it

(Continued on page 19)

PERFECTION

MAKE PERFECTION YOUR STANDARD

NEUTRODYNE 5 TUBE SET

The Neutrodyne Circuit is the last word in Radio and is the best set made today
WORKS WITHOUT AERIAL OR GROUND
Will Receive Any American Station

1 Formica Panel 7x24	1 "A" Battery Switch	3 Jacks 12 Feet Spaghetti
5 Bakelite Sockets	3 Dials, 4-inch	22 Ft. No. 14 Gold Plated Wire
3 Neutroforms	1 Amso Rheostat	1 Condenser, .005 Dubilier
2 Neutrodons	1 Amso Power Rheostat	1 Grid Leak and Condenser, Freshman
2 Franco Audio Transformers	8 Binding Posts with Names	1 Dubilier Condenser, .002

SPECIAL PRICE FOR COMPLETE PARTS \$32.50
LICENSED NEUTRODYNE PARTS for 5 tube set

PERFECTION RADIO CORPORATION
Mail Order Dept., 59 Cortland St., New York City
New York Retail Stores: 59 Cortland St., 78 Cortland St., 119 West 23rd St., 118 Nassau St.
Money Order, Certified Check or C. O. D.

RUSONITE

CRYSTAL RECTIFIER

(Patent Pending)

THE PERFECT SYNTHETIC CRYSTAL DETECTOR, SENSITIVE OVER ENTIRE SURFACE. No Hunting for "Spots." Loud and Clear. Endorsed by thousands of satisfied users. Sensitiveness Guaranteed. Price, Mounted, 50c

14 K. GOLD SUPERSENSITIVE RUSONITE CATWHISKER. Permanent. Will Not Oxidize. Price, Mounted, 25c

RUSONITE REFLEX CRYSTAL. Manufactured Expressly for Reflex Circuits. Will Stand Up Under Heavy Plate Voltage. Guaranteed. Price, Mounted, \$1.00

Order from your dealer or direct from
RUSONITE PRODUCTS CORP.
15 Park Row New York, N. Y.

ONLY **\$29.50**

High Grade Vacuum Tube Set

and
6 Volt World Radio Storage Battery

"Tune in" from Coast to Coast
Hear all of the Long Distance broadcasting stations. This high grade Vacuum Tube Receiving Set in fine mahogany portable cabinet is fully equipped to bring you Opera, Football Scores, Market Reports, Lectures and Vocal and Instrumental Concerts from coast to coast. And in addition, the World Special introductory offer gives you all of the equipment needed to use this wonderful receiver, FREE.

Nothing More to Buy

Retail Value Complete Equipment \$62.50
Our Special Price Complete..... **\$29.50**
Remember, this set is complete ready for use. Every part fully guaranteed by maker and by us. You need not send a penny. Just give name and address; Radio set with complete equipment will be shipped C.O.D., subject to inspection the day your order is received. Or, we will allow 5% reduction for cash with order. Act quick before Special Introductory Offer is withdrawn. ORDER TODAY.

World Battery Co.
Radio Dept.,
Desk 1,
60 East
Roosevelt Rd.,
CHICAGO
ILLINOIS

FREE
Double Head Phones
UV-200 Radiotron Tube
22½ Volt Franco B-Battery
Aerial Wire Lead-in Wire
Ground Clamp, Insulators,
Hydrometer
A Complete
Outfit

World's Biggest Battery Bargain

FREE  **FREE**

Hydrometer and "B" Battery FREE

READ THIS SPECIAL CHRISTMAS OFFER. THEN ACT!

Thousands of Radio Digest Readers will profit by this amazing offer. They will buy the famous 2-year guaranteed World Battery at the lowest price ever quoted. They will get a hydrometer and a "B" Battery FREE. And they get the best battery built. It is "World" quality that makes possible our 2-year ironclad guarantee. It is "World" quality that makes "World" owners "tell their friends." That's the best proof of performance any product can have.

SEND NO MONEY
You need not send a penny. Just clip this ad and attach your name and address. The battery will be shipped to you the day your order is received. When the battery arrives, inspect it—read our 2-year guarantee before you pay one penny. Convince yourself you are protected from every angle—that the World battery price saves you 50%. Get the "B" Battery and hydrometer FREE. Order today.

COMPARE THESE PRICES:
Special 200-hour Rechargeable Storage Batteries

2 Volt for WD-11 and 12 Tubes.....	\$ 5.00
4 Volt for UV-199 Tubes.....	8.00
6 Volt 60 Amp.....	8.50
6 Volt 80 Amp.....	10.00
6 Volt 100 Amp.....	12.50
6 Volt 120 Amp.....	14.50
6 Volt 140 Amp.....	16.00

5% Discount for Cash with Order.

World Battery Co., Dept. L, 60 E. Roosevelt Rd., Chicago, Ill.

World

Send your order today.

TWO STAGE R. F. AND DETECTOR

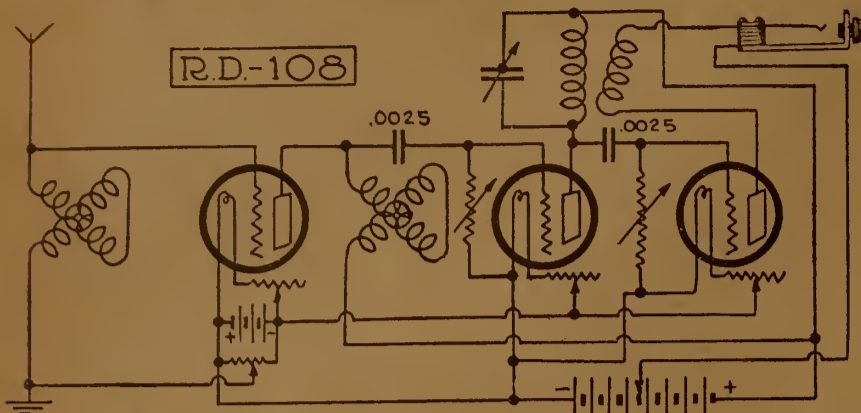

MR. GEO. C. ELLWOOD of San Jose, California, has submitted an unusual circuit using three tubes for two stages of tuned radio frequency and detector, and we show it here as R.D.-108. He uses two variometers and a standard variocoupler and has had some unusual long distance results with the circuit. The potential of the grid of the first tube is controlled by means of a standard potentiometer. Variable grid leaks were found

necessary on the last two tubes. Although the controls are rather numerous, results were found to be unusually good. The addition of two stages of standard audio frequency amplification will give loud speaker volume on even the long distance stations.

Mr. Ellwood has had considerable success with his circuits and likes to send them in for other fans to enjoy.

Review of Books

An Introduction to Radio. A real book for the amateur. This treatise comes in two volumes. 96 pages in each volume, fully illustrated with flexible leather covers. Price two volumes, \$1.00.

How to Retail Radio. A new book telling of tested plans and methods and policies for the dealer in Radio. Financing, location, store equipment and arrangement. Price, \$2.00.

Vacuum Tube Receivers. By O. F. Hessler. A book that tells how to make a simple set. How to make the cabinet. It includes a 27 by 36-inch layout blueprint. Price, 75 cents.

The Armstrong Super-Regenerative Circuit. By George J. Eltz, Jr., E. E. This is a De Luxe edition of this famous circuit. Profusely illustrated and fully explained. Fifty-two pages. Price, \$1.00.

Home Radio—How to Make It. By A. Hyatt Verrill. This book is particularly adapted for the amateur who desires to know how to make Radiophones. Twelve full page illustrations and diagrams. Price, 75 cents.

Elements of Radiotelegraphy. By Elery W. Stone. The text was written for the guidance and instruction of Radio students in the communication service of the Navy. It is an instruction book for Radio schools. Price, \$2.50.

Radio for the Amateur. By A. H. Packer and R. R. Haugh. The underlying

principles of Radio thoroughly explained in simple language and understandable illustrations. This book will teach you how to construct and operate a receiving set successfully. Price, \$1.50.

Radio Reception. By Harry J. Marx, Technical Editor Radio Digest Illustrated, and Adrian Van Muffling. A simple treatise on Radio reception. Beginning with the elementary principles of electricity it carries the reader on into the essentials of Radio telephony. The most successful methods of Radio reception are explained and special reference given to practical tuning. 230 pages, with 130 illustrations. Price, \$2.00.

The book department of the Radio Digest is prepared to send you any of the books on Radio published, whether listed in our Book Review or not. Let us know what book you want, send us your check and we will see that the book is mailed to you. Postage stamps in payment for books not accepted. Send money order or check. Radio Book Department, Radio Digest, 123 W. Madison St., Chicago, Ill.

SPLENDID CHRISTMAS GIFT "WHERE I GO BY RADIO"

New, Original, Handy and Complete Radio Book for Easily Recording for Reference When, Where and How You "listen in," and what you hear. Makes immediate hit. All stations corrected to November 15, 1928.

SPECIAL OFFER—2 Copies Popular Edition, \$1.00; One Holiday Edition, \$1.00, or all three ONLY \$1.75. Start New Year Right.

RADIO BOOK DEPT., PROGRESS PRESS Union, South Carolina, U. S. A.



PREMIER Audio-Frequency Transformer

HERE you have it—the smallest Audio-Transformer ever made, and yet the most efficient for volume and tone quality. Think of it! This "Little Wonder" (about the size of an English walnut) gives you maximum reproduction volume with minimum distortion. The secret is in its patented construction. It is 100% shielded against foreign noises. Mounts anywhere—saves space in assembly. Constructed of highest quality material. Made in tube socket types also. We guarantee it unconditionally. Try them in your next "hook-up." You'll be agreeably surprised and pleased.

Write now for Bulletin No. 90

RATIOS

1 to 3, 1 to 4, 1 to 5... \$3.50
1 to 10..... 4.50

Premier Electric Company
3810 Ravenswood Ave. CHICAGO

Premier at Your Dealers
Ask for and insist on

STAND BY

CASH IN ON

THE GROWING DEMAND

—for high-grade standard radio parts and equipment.

Realistically pictured and described in our big illustrated catalog are the latest improved products of the foremost manufacturers —backed by our big stocks and immediate shipments of every order large or small.

We're ready to take care of you at once on your radio requirements — no delays — liberal discounts.

Ask today for catalog A1001

WAKEM & McLAUGHLIN INC
242 E. ILLINOIS ST. CHICAGO

The RADIO-SHACK

58 Dey Street - New York City
Goods shipped C.O.D.
Just pay the postman

EVERY ARTICLE SOLD ON WRITTEN MONEY-BACK GUARANTEE

1c SALE

One of Six Large New York Stores

Send No Money. We'll Ship Anything C. O. D.

1c SALE

MAKE 2 SETS FOR PRICE OF 1

SUPERTRON TUBES Type 201A uses 6 volts, type W0 12 uses 1 1/2 volts. Excellent as detector or amplifier. Draws 1/4 amp. Oscillate in all circuits. 1 FOR \$6.49.	22 1/2-V. BATTERY Variable Type Reg. \$1.75..\$1.44 Reg. 2.65.. 2.09 Reg. 3.00.. 2.74 45-V. Variable Reg. 3.00.. 2.99 Reg. 4.00.. 3.69 Reg. 5.50.. 5.39	PLUGS Torpedo or Flat, easy adjustment for phone cords. High finish. Perfect contact. Reg. \$1.25. 1 FOR 69c.	JACKS Single or Double Heavy Springs—German Silver Contacts. Nickel finish. Reg. 90c. 1 FOR 59c.	TUBE PROTECTORS It is possible to blow your tubes if you attach these to end of socket for 1/4 or 1 amp. tubes. 1 FOR 49c.	Tested MICA CONDENSERS Only the best ruby mica used. Guaranteed. All capacities. 1 FOR 49c.	KRONE PHONES 2200 Ohms Standard Make. Remarkable Clearness and volume. Can be used with horn. Reg. \$6.50. 1 FOR \$5.89.
LIGHTNING ARRESTERS Approved by Underwriters. You need these for your set. 1 FOR 89c.	VARIABLE CONDENSER 23 PLATE Sturdy construction. Perfect alignment between plates. Reg. \$3.00. 1 FOR \$1.99.	COIL MOUNTS Double or Triple. Beautiful high finish mounts, complete with pig tail wire. 1 FOR \$4.99.	3-IN. DIAL DeForest Type Remarkable Value. Brass Bushing. Tapered Knob. Reg. 50c. 1 FOR 49c.	D. L. COILS 35—50—75—100 Just the size for Three Circuit. 1 FOR 69c.	TRANSFORMERS Audio Frequency well known standard make. Ratio 4-1. Reg. \$5.50. 1 FOR \$5.49.	HYDROMETERS Very Accurate. Packed in wooden moisture proof box. Reg. 75c. 1 FOR 59c.
VERNIER CONTROL For any Dial. Makes a Vernier out of any make condenser. Very efficient. Reg. 75c. 1 FOR 49c.	SWITCH LEVERS Adjustable Arm. Fada Type Knob. Heavy Nickelled arm and collar. Reg. 40c. 1 FOR 29c.	VARIABLE GRID LEAK Panel Type. Needed for proper results. No solder needed. 1 FOR 79c.	RESISTANCE UNITS Used either as a rheostat or as a converter that will make a 6-ohm rheostat good for 199 or 201-A 1 FOR 34c.	MOULDED VARIOMETER A remarkable buy. Green silk wire, pig tail contacts. Can be split. Heavy windings. Reg. \$6.00. 1 FOR \$5.49.	RHEOSTATS Any Resistance. Fada Type with tapered knob and secure wire. 6 ohms.....49c 30 ohms.....59c MORE	VARIO-COUPLED 180 Degree Wound on Genuine Bakelite tubing with green silk wire. Reaches 600 meters. Reg. \$5.00. 1 FOR \$3.89.
SOCKETS Well made in detail. Extra heavy phosphor bronze contacts. Binding post nuts. Metal top...49c All Moulded.59c Wiping Contact...69c	Vernier Condenser with Dial A beautiful moulded end instrument with tapered dial and knob. Precision made. Delicate adjustment. 11 Plate...\$4.49 23 Plate... 4.99 43 Plate... 5.50	LOUD SPEAKER Nickel Plated A small, neat horn for use with single phone. Loud and clear, no distortion. Reg. \$3.50. Extra Special 1 FOR \$3.49.	LITZ WIRE Most Efficient A double silk covered wire with 37 strands of No. 38 wire, each strand enameled. Wonderful for Coils, Loops, etc. 1 FT. FOR 4c.	GOLD BUS BAR Most Efficient. Allows high frequency currents least resistance. Used in finest sets. Reg. 15c. 1 FOR 15c.	CRYSTALS Very Sensitive. Tip Top in name and Tip Top in action. The acme of crystal perfection. 1 FOR 15c.	BATTERY CLIPS For Storage Bat. Extra heavy grip. bites large posts. Makes perfect contact. 1 FOR 49c.

Special Shackdx Set Complete
Set includes all parts, drilled panel, phones, tube, batteries, aerial equipment, etc. Great for D.X.....\$15.00

VICTOGRAND
A beautifully finished speaker with a beautifully mellow tone. Complete, no batteries nor anything extra needed\$9.95

NEUTRODYNE
We have some very attractive buys in Neutrodyne sets and parts. Better drop us a line right away!

ERLA REFLEX
This is a one-tube set, complete with drilled panel, that operates a loud speaker. The tube, batteries, phones and all are included\$32.50

RADIO CONSTRUCTOR FREE WITH EVERY \$1 SALE

Further Details of the Famous Miloplex Hook-Up

Part XIII—What the King X Has Accomplished

By the Mystery Man

DO YOU know what I got for Christmas? I did not. All I got was a signed, sealed and delivered notice from Maggie, via Howler, the dog, which read, "Never mind figuring how many days there are in January; January will mean just about as much to you as one more flea on a dog unless during the remaining seven days of 1923 you can decide whether you are to play the villain in that heart-rending drama, 'The Variometer Hound' or forget your 'rawdeo' and be content to stand by until the heated season furnishes me an alibi to tell my playmates the heat has affected you"; and the sign of the rolling pin lent force to the epistle. That's what I got for Christmas. Except an idea that perhaps none of you tried using a loop tapped at the center and running to the two condenser tie wires for the Christmas circuit. I know how it is; a loop is such a simple thing few, if any, give it much more than the once over. Used correctly it is a bear cat and will do a lot of nice tricks for you.

Well, go to it, now that you have a real idea. Certainly it works. Incidentally, if any of you fans are still doubtful of the King III, remember my mail now totals 902 who swear by it.

But I am quite interested in being able to "keep on eating with my feet under Maggie's table," and I am just wondering how many fan friends I have who will help me sell her the idea. How many would drop Maggie a postal card telling her you love eating (she likes that stuff), telling her to keep me on the job, telling her anything, yes, even that she's a darn good cook.

What will I do—if you do? Well, I'll do two things. Now listen: If 500 of you—yes, you're one of the 500—will drop her a postal card I'll see that every one of you receives in return a picture of Maggie, also of the King. And to show you that one circuit more or less means little

STATIONS WITH LOOP, DECEMBER 3, 1923			
Time P. M.	Station	City	Remarks
6:40	WLAG	Minneapolis, Minn.	Athletic Club Prog
6:50	WOC	Davenport, Iowa.	Announcements.
7:00	KDKA	East Pittsburgh, Pa.	Market Reports.
7:07	KFKB	Milford, Kans.	Some hospital, broadcasting.
7:20	WOAW	Omaha, Neb.	
7:34	WHB	Kansas City, Kan.	Signed off 7:36.
7:45	WTAS	Elgin, Ill.	Picked up several times.
7:53	WWJ	Detroit, Mich.	Educational talk—Music, 7:55.
8:07	WAAW	Omaha, Neb.	Signed off 8:07.
8:20	WCBD	Zion City, Ill.	Quartette.
8:37	KSD	St. Louis, Mo.	
8:53	WOS	Jefferson City, Miss.	Fox trot—Running down the Lane.
8:55	CHBC	Calgary, Alta, Can.	Morning Albertin.
9:00	CKCK	Regina, Sask.	Loud enough for speaker.
10:20	KFKY	Hastings, Neb.	Loud enough for speaker.
11:10	WGR	Buffalo, N. Y.	Signed off 11:55.
11:30	WDAF	Kansas City, Mo.	Night Hawks.
11:35	CFCN	Calgary, Alta, Can.	Very Loud.
11:45	KFI	Los Angeles, Calif.	Examiner.
11:55	KPO	San Francisco, Calif.	Mayo Bros.
12:10	KYW	Chicago, Ill.	Chicago Crier.

STATIONS WITH 35 TO 50-TURN COIL, DECEMBER 3, 1923			
Time P. M.	Station	City	Remarks
7:25	WOAW	Omaha, Neb.	No-No-Nora.
7:50	WTAS	Elgin, Ill.	
8:07	WAAW	Omaha, Neb.	
8:40	KSD	St. Louis, Mo.	
11:40	CFCN	Calgary, Alta.	
9:30	CKCK	Regina, Sask., Can.	
10:20	KFKX	Hastings, Neb.	
11:35	WGR	Buffalo, N. Y.	Signed off 11:57.
11:45	WDAF	Kansas City, Mo.	Signed off 11:35.
12:10	KYW	Chicago, Ill.	

to me I will publish a loop circuit that will make all of you say, "Atta boy!" Not one of those maybe-it's-good circuits, but one that I've had planted up in Roke-

by, Canada, way up in the Saskatchewan

country on test. To show you what it has done I give you a log of its performance for the evening of December 3, and to prove that the loop trick was the best a duplicate set with a 35 and 50 honeycomb coil was used and you can read which one won the silk-lined milk bottle.

None of the log is guesswork, as part of the program is given for verification. You know, it's O.K. for you to guess when I'm on test with a circuit and programs are later verified by letter or I can't count them.

(Continued on page 18)

The New METALECTRIC SOLDERING IRON

Operates on any electric current with the simplicity, ease and efficiency of a writing instrument.

An indestructible all-metal quality product with a worthwhile guarantee.

Accepted as the logical solution to radio soldering problems.

\$5.50
"worth it"



Ample Heat—Interchangeable Tips—Handle always cool

of your dealer or write

POST ELECTRIC CO., Mfrs.
Dept. 509, 30 E. 42nd St.
NEW YORK

TUBES \$5.43
Genuine R. C. A. Radiotrons
UV199, UV201A, WD11, WD12
Guaranteed Firsts in Original Packages

Brandes "Superior" Phones.....	\$4.76
Brandes "Table Talker".....	8.12
Bremer Tully Vernier Tuner.....	3.96
3-Amp. Tungar Type Battery Charger.....	9.38
"Erla" Reflex or Audio Transformers.....	3.96
All American Transformers (All ratios).....	3.82
"Pacnet" New Style Phones.....	3.12
"Como" Push-Pull Transformers (pr.).....	9.87
0 to 50 Pocket Volt-Meter.....	1.12
"Gold Seal" Homecharger.....	14.79
Acme Audio Transformers.....	3.97
23-Pit. Vernier Condenser, Knob and Dial.....	2.13
23-Pit. Variable Condenser.....	1.14

Include postage.—Send for complete list.
SIMPLEX RADIO SALES CO.
1806 Lafayette Ave. St. Louis, Mo.

"3,000 mile"

RADIO "B" BATTERIES
At Factory Prices

Greatest Radio "B" battery on market. Full number voltage taps; QUALITY GUARANTEED; LOWEST PRICES; brings in concerts LOUDER AND STRONGER; will work on any tube or lead speaker. Order by number TODAY with check, money order or pay postman C. O. D.

No. 322B—22½ volt, variable, regularly \$2.25.....	\$1.52
No. 322A—22½ volt, variable, regularly \$3.00.....	\$1.85
No. 345A—45 volt, 8 taps, regularly \$5.50.....	\$3.25

AYRES BATTERY CORPORATION, Cincinnati, Ohio

RADIO PANELS

Cut exactly to size and a guaranteed 12 hour shipment. ¼" thick .01½¢ per square inch, 3/16" thick .01¼¢. Made of the highest grade black fibre. This material possesses electrical strength of 200 volts per mil, is inexpensive, unbreakable, easy to work and takes a fine finish. We pay postage.

RADIO INSTRUMENT AND PANEL CO.
564 West Monroe Street Chicago, Illinois

WILLARD RADIO COMPANY
291 Broadway New York City
"The Best for Less"

REINARTZ CIRCUIT EVERY PART COMPLETE

1 Reinartz wound coil, 1 tube socket, 1 rheostat, 1 23-plate .0005 MFD. variable condenser, 1 13-plate .00025 MFD. variable condenser, 3 inductance switches, 23 switch points and nuts, 6 switch stops and nuts, 8 binding posts, 2 3" dials, 1 variable grid leak, 1 .002 MFD. phone condenser, 23 feet bus bar wire, 1 high-grade panel ALREADY DRILLED AS PER DIAGRAM **\$10.95**

and complete instructions.....
Two-Stage Audio Frequency Amplifier—Parts complete in every detail for this Circuit—\$11.00
Specify type of tubes you intend using

FLEWELLING CIRCUIT EVERY PART COMPLETE

2 honeycomb coils, 1 2-coil mounting, 2 coil plugs, 3 .005 condensers, 1 variable grid leak, 1 grid leak, 1 23-plate .0005 MFD. variable condenser, 1 Vernier rheostat, 1 tube socket, 8 binding posts, 20 feet bus bar wire, 1 3" dial and 1 high grade panel ALREADY DRILLED AS PER DIAGRAM IN BOOKLET OF INSTRUCTION SENT FREE **\$11.95**

Two-Stage Audio Frequency Amplifier—Parts complete in every detail for this Circuit—\$11.00
Specify type of tubes you intend using

<p>CONDENSERS</p> <p>3 Plate Variable; value, \$1.75.....\$1.05</p> <p>11 Plate Variable; value, \$2.50.....1.20</p> <p>13 Plate Variable; value, \$2.50.....1.20</p> <p>17 Plate Variable; value, \$3.50.....1.35</p> <p>23 Plate Variable; value, \$3.50.....1.35</p> <p>43 Plate Variable; value, \$4.50.....1.95</p> <p>13 Plate VERNIER; value, \$5.50.....\$3.75</p> <p>23 Plate VERNIER; value, \$6.00.....4.00</p> <p>43 Plate VERNIER; value, \$6.50.....4.25</p> <p>BEST QUALITY JACKS, Single Circuit; value, 65c; special at......30</p> <p>Double Circuit; value, 90c; special at......45</p> <p>MULTIPLE POINT INDUCTANCE SWITCH with Knob and Dial (15 Switch Points).....\$1.25</p> <p>LIGHTNING ARRESTERS approved by underwriters......90</p> <p>THREE-INCH DIALS—Unbreakable—heat resisting composition—high finish; special......30</p> <p>TWO-INCH DIALS—Same design—for rheostats and potentiometer; special at......25</p> <p>TELEPHONE PLUGS......60</p>	<p>Filament Rheostat, 6 ohm......65</p> <p>Filament Rheostat, 20 ohm......80</p> <p>Filament Rheostat, 50 ohm......90</p> <p>With 2" Dial, 15c extra</p> <p>Honeycomb Coils, 50 turns mounted....95</p> <p>Honeycomb Coils, 75 turns mounted...1.00</p> <p>Double Coil Mountings.....2.45</p> <p>Triple Coil Mountings.....3.35</p> <p>Reinartz Coils, increased wave-length and mounting.....1.95</p> <p>AUDIO FREQUENCY TRANSFORMER—Designed for use with W. D. II \$2.75</p> <p>Tubes, list, \$4.50; price.....</p> <p>BALL BEARING INDUCTANCE SWITCH—value, 75c; special......25</p> <p>V. T. SOCKETS—Nickel-plated brass sleeve, composition base; value, \$1.00; special at......40</p> <p>EXTRA SPECIAL—Telephone 3000 Ohms Headsets; \$9.00 value; reduced to.....3.50</p> <p>Vernier Dial Adjuster, List, 35c; special......25</p> <p>FRESHMAN VARIABLE RESISTANCE LEAK and MICA CONDENSER Combined....75</p>
---	--

Every article advertised above is guaranteed by the manufacturer and by us—Mail orders filled immediately—transportation PREPAID on all orders of \$5.00 or over east of the Mississippi River. Send cash, check or money order—absolutely no goods sent C. O. D.

2-LO, LONDON, ENGLAND ON ONE TUBE

Another Record for the **ELGIN SUPER-REINARTZ**

Tuesday, November 27, during the test period between 9 and 9:30 P. M., Rev. E. A. Cole in the residence of J. A. McIver, of Roodhouse, Ill., while operating a set made of materials and in accordance with the hookup furnished by the ELGIN RADIO SUPPLY CO., tuned in 2-LO, London, England, using receivers and but one tube. Later another tube was lighted and the loud speaker used, so that four people could hear the program and concluding announcement. The numbers, time, and the order in which they were played were

Officially Confirmed

by the St. Louis Post Dispatch in conjunction with the National Association of Broadcasters, who had charge of the tests. (See page 34, St. Louis Post Dispatch, Dec. 2, 1923.) This same hookup has been advertised extensively as the one which brings in stations 2000 miles overland on a loud speaker and one tube; and this has been demonstrated so often as to need no repetition.

Send a two-cent stamp for circular giving one, two, and three tube hookup, and price list of parts for this remarkable circuit. Address the

ELGIN RADIO SUPPLY CO.
207 Chicago St. ELGIN, ILL.

CAPTAINS WATCH ARTIES USHER OUT OLD YEAR

These Stories Will Aid Opera Listeners

STORY OF KOENIGSKINDEN
 WMAQ December 25
 THE ABOVE, for those who do not read German, is translated "Kingly Child." This is a most unlikely tale; a fairy story that does not end and that happily ever after, and a witch's prophecy that does not come true. The story is controversial. A king's son falls in love with a goose-girl who lives with an ugly witch. The witch, when consulted by the people of a neighboring kingdom, prophesies that the next ruler will be the first person who enters the gates after we're the best queen. The little goose-girl, of course, enters and the people will not accept her as their queen. Later on their repent and find her and the king's son dead in the forest in the snow.

STORY OF CLEOPATRA KTW December 28

MARY GARDEN makes her Radio debut this year in the opera "Cleopatra." The story is the story of how a famous Roman emperor was rained many years ago by an Egyptian queen, leaving his wife and his country to spend the happy days in sunny Egypt. Cleopatra has interpreted many lives as a beautiful woman, but to this opera she loves Anthony. When he does in her arms she will not accept her as his Roman army, she lets her pet asp bite her so that she may also die.

Here we have Otto E. Krueger, conductor of the Detroit New Orchestra, an organization made up of eight musicians of rare ability. The orchestra, organized in May 1922 is a daily feature of the programs sent by The Detroit News, Station WWJ.

Miss Louise Koetter, contralto soloist of the Presbyterian Church of the Covenant, Cincinnati, whose voice is heard each Sunday from this station as broadcast by Station WLW. The Crosley Manufacturing Company introduced this charming number via Radio and it has become the hit of the year.

Above, Gaeper Pappalardo, leader of the well-known Hotel Gayoso orchestra at Memphis, Tennessee, which is often featured in programs broadcast by WMAQ. She is a guest artist in a concert presented by WMAQ, Chicago, Ill. (Central, 447.3), 1:00 p. m., December 29.

In the circle is Claire Dux, who took the part of "goose-girl" in the "Koenigskinder" to be broadcast on Christmas day by WMAQ. She is a guest artist in a concert presented by WMAQ, Chicago, Ill. (Central, 447.3), 1:00 p. m., December 29.

The Hypocrite Boys, Ernest Hart & Billy Jones; 8:15-9:30. Old Fashioned Minstrel Show; 9:30-10:00. Art Coffee Orchestra; 10:00-10:20. Louise Kelly, lyric soprano.

WFAA, Dallas, Texas (Central, 476), 12:30-1:00 p. m. "The World for Christ." Dr. Robert S. Hays; 8:30-9:30. Recital by faculty. North Texas State Teachers College.

WCI, Medford Hillsdale, Mass. (Eastern, 360), 8:00 p. m. "The Nightingale." Dorothy H. Goodwin; 7:30, Charles L. H. Wagner, Radio Post; Red Cross Health Club, Henry H. H. Wagner, Radio Post; Red Cross Health Club, Henry H. H. Wagner, Radio Post; Red Cross Health Club, Henry H. H. Wagner, Radio Post.

WGR, Buffalo, N. Y. (Eastern, 318), 12:30-1:00 p. m. "The World for Christ." Dr. Robert S. Hays; 8:30-9:30. Recital by faculty. North Texas State Teachers College.

WMAQ, Chicago, Ill. (Central, 447.3), 1:00-2:30 p. m. "The World for Christ." Dr. Robert S. Hays; 8:30-9:30. Recital by faculty. North Texas State Teachers College.

WMAQ, Chicago, Ill. (Central, 447.3), 1:00-2:30 p. m. "The World for Christ." Dr. Robert S. Hays; 8:30-9:30. Recital by faculty. North Texas State Teachers College.

WMAQ, Chicago, Ill. (Central, 447.3), 1:00-2:30 p. m. "The World for Christ." Dr. Robert S. Hays; 8:30-9:30. Recital by faculty. North Texas State Teachers College.

WMAQ, Chicago, Ill. (Central, 447.3), 1:00-2:30 p. m. "The World for Christ." Dr. Robert S. Hays; 8:30-9:30. Recital by faculty. North Texas State Teachers College.

WMAQ, Chicago, Ill. (Central, 447.3), 1:00-2:30 p. m. "The World for Christ." Dr. Robert S. Hays; 8:30-9:30. Recital by faculty. North Texas State Teachers College.

Tuesday, December 25

KDKA, E. Pittsburgh, Pa. (Eastern, 326), 11:30 a. m. Noonday Concert; 6:30, Pittsburgh Athletic Association Orchestra; 7:45, Children's period; 8:15, "The Advocate of Periodic Health Examinations"; 9:20, Barnes Children's Orchestra; 9:50, F. J. Feltner, pianist; "Shooting as a Sport." Capt. D. M. Hartow. "The Care of Clothing," E. Belle

WJAZ, Chicago, Ill. (Central, 447.3), 7:45 p. m. "Koenigskinder," opera at the Auditorium Theater, by Chicago City Opera Co. opera in German, music by Friedrich Schlegel; "The Merry Widow," opera by Franz Lehár; "The Merry Widow," opera by Franz Lehár; "The Merry Widow," opera by Franz Lehár.

WJAZ, Chicago, Ill. (Central, 447.3), 7:45 p. m. "Koenigskinder," opera at the Auditorium Theater, by Chicago City Opera Co. opera in German, music by Friedrich Schlegel; "The Merry Widow," opera by Franz Lehár; "The Merry Widow," opera by Franz Lehár.

WJAZ, Chicago, Ill. (Central, 447.3), 7:45 p. m. "Koenigskinder," opera at the Auditorium Theater, by Chicago City Opera Co. opera in German, music by Friedrich Schlegel; "The Merry Widow," opera by Franz Lehár; "The Merry Widow," opera by Franz Lehár.

Wednesday, December 26

WMAQ, Chicago, Ill. (Central, 447.3), 1:00-2:30 p. m. "The World for Christ." Dr. Robert S. Hays; 8:30-9:30. Recital by faculty. North Texas State Teachers College.

WMAQ, Chicago, Ill. (Central, 447.3), 1:00-2:30 p. m. "The World for Christ." Dr. Robert S. Hays; 8:30-9:30. Recital by faculty. North Texas State Teachers College.

WMAQ, Chicago, Ill. (Central, 447.3), 1:00-2:30 p. m. "The World for Christ." Dr. Robert S. Hays; 8:30-9:30. Recital by faculty. North Texas State Teachers College.

WMAQ, Chicago, Ill. (Central, 447.3), 1:00-2:30 p. m. "The World for Christ." Dr. Robert S. Hays; 8:30-9:30. Recital by faculty. North Texas State Teachers College.

Thursday, December 27

WMAQ, Chicago, Ill. (Central, 447.3), 1:00-2:30 p. m. "The World for Christ." Dr. Robert S. Hays; 8:30-9:30. Recital by faculty. North Texas State Teachers College.

WMAQ, Chicago, Ill. (Central, 447.3), 1:00-2:30 p. m. "The World for Christ." Dr. Robert S. Hays; 8:30-9:30. Recital by faculty. North Texas State Teachers College.

WMAQ, Chicago, Ill. (Central, 447.3), 1:00-2:30 p. m. "The World for Christ." Dr. Robert S. Hays; 8:30-9:30. Recital by faculty. North Texas State Teachers College.

WMAQ, Chicago, Ill. (Central, 447.3), 1:00-2:30 p. m. "The World for Christ." Dr. Robert S. Hays; 8:30-9:30. Recital by faculty. North Texas State Teachers College.

Friday, December 28

KDKA, E. Pittsburgh, Pa. (Eastern, 326), 12:10 p. m. Noonday concert; 6:15, Lucile Hall, organist; 7:15, Radio Boy Scouts Musical, Richard Victor; 8:00, "The World for Christ," Dr. Robert S. Hays; 8:30, Mary Huntsman, pianist; "The Merry Widow," opera by Franz Lehár; "The Merry Widow," opera by Franz Lehár.

WMAQ, Chicago, Ill. (Central, 447.3), 1:00-2:30 p. m. "The World for Christ." Dr. Robert S. Hays; 8:30-9:30. Recital by faculty. North Texas State Teachers College.

WMAQ, Chicago, Ill. (Central, 447.3), 1:00-2:30 p. m. "The World for Christ." Dr. Robert S. Hays; 8:30-9:30. Recital by faculty. North Texas State Teachers College.

WMAQ, Chicago, Ill. (Central, 447.3), 1:00-2:30 p. m. "The World for Christ." Dr. Robert S. Hays; 8:30-9:30. Recital by faculty. North Texas State Teachers College.

Saturday, December 29

WMAQ, Chicago, Ill. (Central, 447.3), 1:00-2:30 p. m. "The World for Christ." Dr. Robert S. Hays; 8:30-9:30. Recital by faculty. North Texas State Teachers College.

WMAQ, Chicago, Ill. (Central, 447.3), 1:00-2:30 p. m. "The World for Christ." Dr. Robert S. Hays; 8:30-9:30. Recital by faculty. North Texas State Teachers College.

WMAQ, Chicago, Ill. (Central, 447.3), 1:00-2:30 p. m. "The World for Christ." Dr. Robert S. Hays; 8:30-9:30. Recital by faculty. North Texas State Teachers College.

WMAQ, Chicago, Ill. (Central, 447.3), 1:00-2:30 p. m. "The World for Christ." Dr. Robert S. Hays; 8:30-9:30. Recital by faculty. North Texas State Teachers College.



Mary Garden—"Our Mary" as Chicagoans have been wont to call this child of their city for many years—sings for the first time from KTW for nearly a year, on Friday, December 28. Radiophans will then hear her as "Cleopatra" in the opera of the same name

Sunday, December 30

KFL, Los Angeles, Calif. (Pacific, 468), 10:30-10:45 p. m. In Church Federation Service; 4:30-5:00 p. m. Federal Church Musicians; 6:45-7:30. Opera story and concert; 10:30-11:00, Theatrical Banquet; 8:00-9:00, U.S. Navy Band; 8:30-9:00, U.S. Navy Band; 8:30-9:00, U.S. Navy Band; 8:30-9:00, U.S. Navy Band.

WMAQ, Chicago, Ill. (Central, 447.3), 1:00-2:30 p. m. "The World for Christ." Dr. Robert S. Hays; 8:30-9:30. Recital by faculty. North Texas State Teachers College.

WMAQ, Chicago, Ill. (Central, 447.3), 1:00-2:30 p. m. "The World for Christ." Dr. Robert S. Hays; 8:30-9:30. Recital by faculty. North Texas State Teachers College.

WMAQ, Chicago, Ill. (Central, 447.3), 1:00-2:30 p. m. "The World for Christ." Dr. Robert S. Hays; 8:30-9:30. Recital by faculty. North Texas State Teachers College.

RTIES LISHED OUT OLD YEAR

5), 9:00 p. m.,
 6), 8:30 p. m.,
 7), 6:00 p. m., The
 8), 12:00 a. m.,
 9), 11:00 a. m.,
 10), 10:00 p. m.,
 11), 8:00 p. m.,
 12), 7:00 p. m.,
 13), 6:00 p. m.,
 14), 5:00 p. m.,
 15), 4:00 p. m.,
 16), 3:00 p. m.,
 17), 2:00 p. m.,
 18), 1:00 p. m.,
 19), 12:00 p. m.,
 20), 11:00 a. m.,
 21), 10:00 a. m.,
 22), 9:00 a. m.,
 23), 8:00 a. m.,
 24), 7:00 a. m.,
 25), 6:00 a. m.,
 26), 5:00 a. m.,
 27), 4:00 a. m.,
 28), 3:00 a. m.,
 29), 2:00 a. m.,
 30), 1:00 a. m.,
 31), 12:00 a. m.

er 30
 1), 10:00-10:45
 2), 9:00-9:45
 3), 8:00-8:45
 4), 7:00-7:45
 5), 6:00-6:45
 6), 5:00-5:45
 7), 4:00-4:45
 8), 3:00-3:45
 9), 2:00-2:45
 10), 1:00-1:45
 11), 12:00-12:45
 12), 11:00-11:45
 13), 10:00-10:45
 14), 9:00-9:45
 15), 8:00-8:45
 16), 7:00-7:45
 17), 6:00-6:45
 18), 5:00-5:45
 19), 4:00-4:45
 20), 3:00-3:45
 21), 2:00-2:45
 22), 1:00-1:45
 23), 12:00-12:45
 24), 11:00-11:45
 25), 10:00-10:45
 26), 9:00-9:45
 27), 8:00-8:45
 28), 7:00-7:45
 29), 6:00-6:45
 30), 5:00-5:45
 31), 4:00-4:45

Saturday, December 29

Tales for the Kiddies; Current Book Review, R. A. MacDonald; "A Better New Year," Howard W. Selby; 11:00, WBZ Quintette; Mrs. Melva Holmes, soprano; Mrs. W. S. Larsen, reader. 10:00 p. m. WDAF, Chicago, Ill. (Central, 360), 10:00 p. m. George R. Hill, Jr., baritone; H. H. Hange, tenor; Jack Chapman's Orchestra.
 WDAR, Philadelphia, Pa. (Eastern, 395), 12:00 m., Organ recital, Stanley Theater; Arcadia Cafe Concert Orchestra; 2:00-3:00 p. m., Piano recital, Edna Finestone; Arcadia Cafe Concert Orchestra; 7:30, Bedtime stories, Dream Daddy; 7:50, Book review by Yarnell Abbott; 10:10, Special Morning Glory Club features; Songs by Harry Glyn; Dance music, Howard Lanin's Arcadia Cafe Orchestra.
 WEA, New York, N. Y. (Eastern, 492), 11:00-11:25 a. m., Musical America; 11:50-12:00, Market reports; 4:00-4:30 p. m., Augusta Cooper, contralto; 4:30-4:45, Evelyn Kempf, pianist; 4:45-5:05, Ellen Campbell, pianist; 5:05-5:30, Bernard A. Ahrens, baritone; 7:30-7:40, Thornton Fisher Sport Talk; 7:45-8:15,

WWJ, Detroit, Mich. (Eastern, 917), 9:00 a. m., Jean Kilde's Dinner; Woman's Editor; 12:00 m., Jean Goldkette's Orchestra; 3:00, Detroit News Orchestra; 7:00, Detroit News Orchestra; Anne Campbell, Detroit News poet; Vocal numbers, Clyde Nichols.
 CKAC, Montreal, Can. (Eastern, 430), 7:00 p. m., Kiddies' stories in French and English; 7:30, Concert, directed by Mrs. J. Marcell and Mrs. N. Smeals.
 KDKA, E. Pittsburgh, Pa. (Eastern, 326), 1:30 p. m., Dougherty's Orchestra; 6:15, Westinghouse Band; 7:30, "Bringing the World to America," "Our World"; 7:45, Children's period; 8:30, Westinghouse Band.
 bedtime stories; 8:00, Talk by professor of College of Pharmacy of Philadelphia; 10:10, Charlie Kerr and his St. James Hotel Orchestra.
 WJAZ, Chicago, Ill. (Central, 447.7), 10:00-2:00 a. m., John Leveridge, pianist; Hope Jennings, cellist; Louise Lang, violinist; Oriole Orchestra.
 WJZ, New York, N. Y. (Eastern, 455), 3:45 p. m., "Poems," Mary Gleason; 4:00, Hotel Belmont Stringed Ensemble; Harry Lerner, leader; 7:00, "Uncle Wiggily Stories," Howard Garis; 7:30, Lily Choristers; 7:45, "Congress and the House of Representatives," Hon. F. H. La Guardia; 8:05, Lily Choristers; 8:30, "Under the Red Robe," Victor Herbert's Cosmopolitan Theater Orchestra; 10:00, Margaret Manlere, soprano; 10:30, Harold Stern and his Hotel Majestic Orchestra.
 WLW, Cincinnati, Ohio (Central, 309), 9:30 p. m., Sunday School Service, Editorial Staff of Sunday School Publications, Methodist Book Concern; 11:00, Services of the Church of the Covenant, Rev. Frank Stevenson, pastor.

WMB, Memphis, Tenn. (Central, 500), 8:30 p. m., Hotel Gayoso Concert Orchestra, Prof. Gaspar Pappalardo, director.
 WOAW, Omaha, Nebr. (Central, 526), 9:00 p. m., Community program, talent from Farragut, Iowa, Orchestra; Male Quartet; Fred Long, cornetist; Charles Comstock, reader; Mrs. Albert Turnbull, Mrs. Howard Johnson, pianists; Talk, J. J. Whistler.
 WOO, Philadelphia, Pa. (Eastern, 509), 11:00 a. m., Organ recital, Mary E. Vogt; 12:00-1:00 p. m., Dinner music, Wanamaker Crystal Tea Room Orchestra; 5:15, Organ recital, Mary E. Vogt; 7:30, Dinner music, Adolphia Hotel Orchestra; 9:00, Organ recital, Mary E. Vogt; 10:10, Dance music, Adolphia Hotel Orchestra.
 WOR, Newark, N. J. (Eastern, 405), 6:15-7:45 p. m., Halsey Miller and his Newark Athletic Club Orchestra, "Music While You Dine," 8:00-8:15, "Current Motion Pictures," Alfred J. McCosker; 8:30-8:45, "Radio Cartooning," Jolly Bill Stehke.

WMB, Memphis, Tenn. (Central, 500), 8:30 p. m., Hotel Gayoso Concert Orchestra, Prof. Gaspar Pappalardo, director.
 WOAW, Omaha, Nebr. (Central, 526), 9:00 p. m., Community program, talent from Farragut, Iowa, Orchestra; Male Quartet; Fred Long, cornetist; Charles Comstock, reader; Mrs. Albert Turnbull, Mrs. Howard Johnson, pianists; Talk, J. J. Whistler.
 WOO, Philadelphia, Pa. (Eastern, 509), 11:00 a. m., Organ recital, Mary E. Vogt; 12:00-1:00 p. m., Dinner music, Wanamaker Crystal Tea Room Orchestra; 5:15, Organ recital, Mary E. Vogt; 7:30, Dinner music, Adolphia Hotel Orchestra; 9:00, Organ recital, Mary E. Vogt; 10:10, Dance music, Adolphia Hotel Orchestra.
 WOR, Newark, N. J. (Eastern, 405), 6:15-7:45 p. m., Halsey Miller and his Newark Athletic Club Orchestra, "Music While You Dine," 8:00-8:15, "Current Motion Pictures," Alfred J. McCosker; 8:30-8:45, "Radio Cartooning," Jolly Bill Stehke.

EASY TO BUILD

Complete instructions for assembling and blueprints for wiring are included with each outfit. Instructions written so everyone can understand them. No special skill or technical knowledge required—a few hours and you're ready to tune in New York, Los Angeles—any of 'em!

Invest that Christmas money in a good Radio Set

We've listed below complete parts for 5 splendid receivers for you to choose from—a radio for every pocket-book. Send for your set today. Don't miss out on this best time of the year for radio—the time when distance records are being made daily.

Panels Drilled FREE

Specially drilled panels are included with each of the sets illustrated and described below. We give this free service only on panels included with complete sets.

Variable Condensers

\$7.00 value, 43 Plate Vernier	\$3.95
6.50 value, 23 Plate Vernier	3.45
6.00 value, 11 Plate Vernier	2.95
1.75 value, 3 Plate Vernier	1.15
4.50 value, 43 Plate NOW..	1.75
3.70 value, 23 Plate NOW..	1.45
3.30 value, 11 Plate NOW..	1.35
2.25 value, 5 Plate NOW..	1.25

Automatic Electric LONG RANGE Headsets

Formerly sold by the Automatic Electric Co., makers of telephone exchanges, at \$10 each. We bought their entire stock—40,000 phones—paid spot cash and because of this unequalled buying power, we are able to offer you a \$10 headset for \$3.65. 30 years of experience have produced the Automatic headset. Coil is wound with about 6500 turns of No. 40 enamel coated copper wire. DC resistance 1600 ohms. Impedance, at average music and voice frequency (800 cycles) 21,000 ohms. (Effective impedance rather than DC resistance is the big factor in a good headset.)

Western Electric VT-2 TUBES

One of the big features of these brand new genuine Western Electric VT-2 Tubes that we bought from the U. S. Signal Corps is that they have a higher amplification factor than any other 5-watt tube made! And almost half of our purchase, consisting of 10,000 tubes have been sold. Radio men know that a genuine VT-2 Tube for \$7.45 is an unusual opportunity—a real "find"! These tubes may be used for both RF and AF amplification and for CW and phone transmitting. These are not Navy defects; they have been sold only as a surplus.



\$7.45

Honeycomb Coils

1,500 Turns\$1.50
1,250 Turns1.50
1,000 Turns1.25
750 Turns1.00
250 Turns75
150 Turns60
100 Turns50
75 Turns40
50 Turns40
35 and 25 Turns40



\$10.00 VALUE
\$3.65

Coils for Cockaday Circuit
Special **\$1.95** at

R. C. Cabinets

Genuine 5-ply Veneer Mahogany Cabinets—the same Cabinet used in the R. C. Radiola set. These Cabinets cost the Radio Corp. \$4.20 in thousand lots.

Size, 9 1/4 x 13 1/4

Our Price **\$2.95**



DEPT. D-6
509 South State St.
CHICAGO, ILL.

Important!
Any individual part (except the drilled panels) in any of the five outfits below may be purchased separately at the special reduced prices listed under column headed "Our Price."

Build your sets with "Salvage Parts" COCKADAY

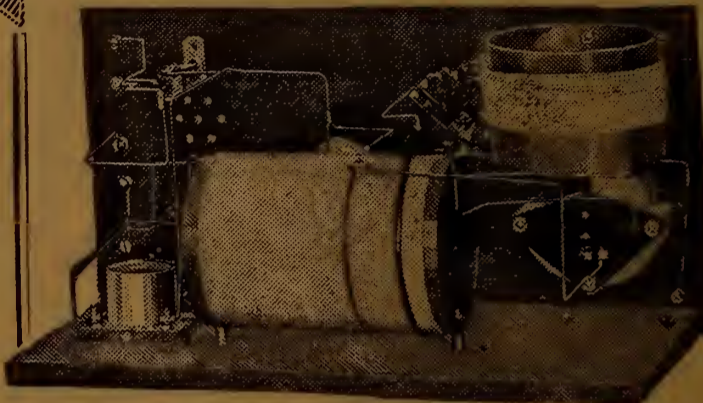

HAZELTINE NEUTRODYNE

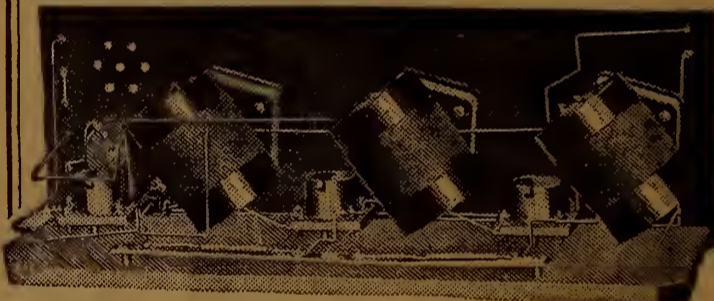

Regular Price EACH	Consisting of	Our Price EACH
\$3.00	1 Cockaday Coil\$1.95
1.00	2 Bakelite Dials25
1.00	1 John Firth Socket45
1.00	1 Freshman Grid Leak and Condenser65
1.50	1 Howard Vernier Rheostat1.35
1.00	1 Patent Double Circuit Jack50
.80	8 Binding Posts85
.02	7 Switch Points91
.50	1 Switch Lever25
	1 7x14x1/2 Formica Panel1.44
	Blueprint and Wire1.00
	1 Baseboard25
3.30	2 23 Plate Condensers1.45

Our Price **\$11.95**

All Parts Licensed Under Hazeltine Patents

- 1 7x21x1/16 drilled Formica panel
- 1 Howard rheostat
- 3 4-inch Radion dials
- 3 John Firth bakelite sockets
- 8 Binding posts
- 3 23 plate variable condensers
- 1 Wave control neutroformer
- 2 Radio frequency amplifying neutroformers
- 2 Grid neutralizing condensers
- 1 .00025 micon grid condenser
- 1 Marco variable grid leak
- 1 Baseboard for mounting
- 25 feet tinned copper bus bar wire and complete instructions for assembling and wiring.

3 TUBE
OUR PRICE **\$28.60**
4 Tube **\$44.65**
5 " **\$46.25**

(Freed-Eissman or Fada Neutroformers)

FORMICA

Made from Anhydrous Redmanol Resins SHEETS TUBES RODS



We are prepared to furnish promptly and saw Formica panels of any dimensions. Cutting charge is included in the following prices:

- 3/8-inch Formica, sq. in.... 2c
- 1/2-inch Formica, sq. in.... 1 1/2c
- Tubing (2 to 4-inch diameter), per running inch.... 10c



REINARTZ DETECTOR

Reg. Price	Consisting of	Our Price
\$1.89	7x18 Formica Panel\$1.70
1.00	Bakelite Socket45
1.50	Howard Vernier Rheostat1.35
3.30	23-Plate Variable Condenser1.45
3.10	11-Plate Variable Condenser1.35
1.50	3 Switch Levers75
.80	2 Dozen Switch Points40
3.00	1 Schoonhoven Reinartz Coil1.95
1.00	Freshman Variable Grid Leak and Condenser combined75
.80	8 Binding Posts40
.30	25 Feet Tinned Wire15
.50	Baseboard for Mounting25
1.00	Blueprint with Complete Instructions for Assembly and Wiring50

Regular Price \$21.69

Our Price **\$11.45**

Complete parts for Detector and two-step with Vernier Condensers.... **\$29.95**

Autoplex Circuit

	Our Price
9 1/2 x 13 1/4 x 1/2 inch Formica Panel, drilled and machined\$1.89
9 1/2 x 13 1/4 x 1/2 inch Mahogany Cabinet with hinged top2.95
1 John Firth Socket35
1 Frost Plain Rheostat1.00
2 Moulded Autoplex Variometers7.30
2 3-inch Bakelite Dials50
6 Binding Posts30
1 Single Circuit Patent Jack35
1 1250 or 1500 Turn Honeycomb Coil1.50
1 4x4x1/2 inch Formica sub-base panel drilled25
1 2 1/4 x 2 1/4 x 1/2 inch Formica Panel, Coil, clamp drilled07
1 Complete set of machine screws necessary for assembling the various parts(no charge)
1 Hookup for assembling and wiring(no charge)
4 Lengths sq. bus bar wire for wiring10

Our Special Price **\$16.45**

Complete parts for

Wave Trap

Consisting of	Our Price
6x6 1/2 Mission Finished Oak Cabinet\$.95
6x6 1/2 Formica Panel Drilled and Engraved50
Specially Wound Wave Trap Coil1.95
23-Plate Variable Condenser1.35
Bakelite Dial25
4 Binding Posts20

Construction Sheet FREE

Very Special **\$5.25**

Complete parts for Erla Single Tube Reflex

Consisting of	Our Price
1 Variocoupler\$3.45
23-Plate Variable Condenser1.45
2 Erla Sockets1.30
1 Erla Reflex No. 1 Transformer4.45
1 Erla A. F. Transformer4.85
1 Erla .002 Mica Condenser30
1 Erla .001 Mica Condenser30
1 Erla .00025 Mica Condenser25
1 Erla Fixed Crystal Detector1.00
1 Howard Rheostat1.00
2 Bakelite Dials50
8 Binding Posts40
1 Dozen Switch Points and 4 Stops30
2 Switch Levers50
1 6 1/2 x 14 x 1/2 in. Formica Panel1.37

Our Price **\$20.90**

Complete parts for 2-Stage Amplifier

To amplify Ultra-Audion, Reinartz, Flewelling, Knocked-Down Short-Wave Receiver, Crystal or any receiving set so that loud speaker or phonograph can be used in place of headset.

Reg. Price	Consisting of	Our Price
\$1.05	7x9 Formica Panel (other suitable size)\$.95
.475	High Ratio All-American or Thordarson Transformer3.95
.450	Low-Ratio All-American or Thordarson3.95
2.20	2 Howard Rheostats2.00
2.00	2 Bakelite Sockets50
3.00	3 Double Patent Jacks1.50
1.30	13 Binding Posts65
.30	Baseboard15

\$21.00 Value Our Price **\$12.95**

Simple Explanation of Radio for Everybody

Chapter VII, Part III—Antennas and Grounds

By M. W. Thompson

THE following article is the fourteenth of a series for Radio beginners, written by Marvin W. Thompson, well known in air-phone circles for his understandable style of approaching his subject. The remaining chapters will be:

- Chapter VIII—Regeneration.
- Chapter IX—Audio Frequency Amplification.
- Chapter X—Loud Speakers.

FIGURE 53 shows a cage aerial, which is more of a transmitting than a receiving aerial, though the owner of a receiving set may erect it for reception, if he likes. The supporting hoops should be about 3 feet in diameter, made of

of this last insulator being attached to a short length fastened to the roof.

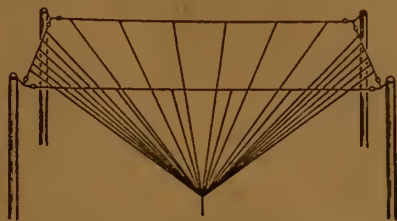

Figure 55—The four-fan antenna is unsurpassed in efficiency but difficult of erection

Figure 55 shows a four-fan aerial, this being given for those who wish to and can experiment with aerials. The four-

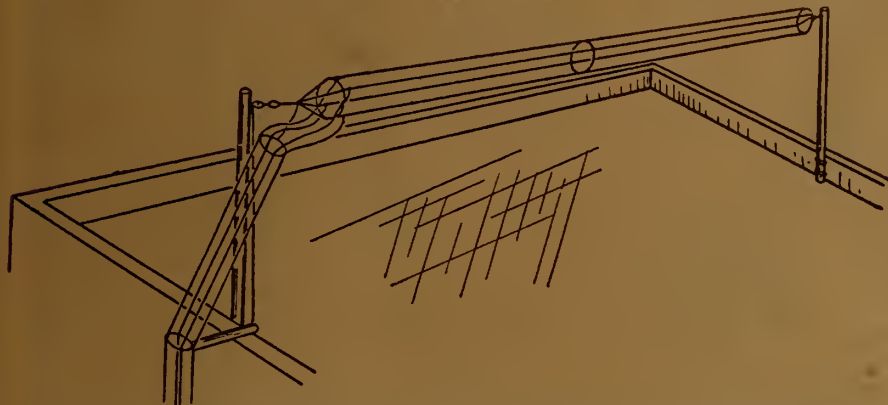

Figure 53—The cage antenna as used by amateurs for transmission is also good for reception

any material, and of sufficient tensile strength not to break and twist. The argument advanced by users of this aerial for transmitting is that the energy is more evenly distributed, it being claimed that, with a four-wire inverted L, most of the energy is in the two outer wires. The hoops for the cage lead-in are 6 inches across and serve both to keep the wires separated and to support them away from the wall.

Fan Aerial

The fan aerial was one of the earliest types used and the only good reason for its less frequent employment now is the

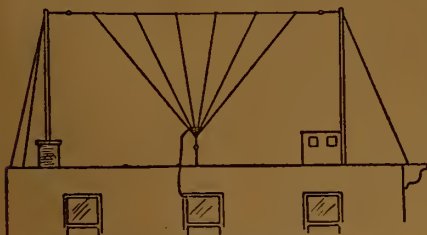

Figure 54—The fan aerial is one of the older types and very efficient

fact that other types are more easily erected. Figure 54 illustrates the fan type, and it should be noted that an insulator is placed at each end of the support wire about 1 foot from the poles and another just below the point where all wires come together, the lower end

fan aerial should prove excellent, being equally efficient in all directions.

The Spiral

Last, we have the spiral. Where space is limited, as on an automobile, motorboat, houseboat, etc., the spiral will give excellent results. It may be hung either vertically or horizontally (see Figures 56 and 57.)

This aerial is easily constructed by taking two light brass hoops, about 2 feet in diameter, and connecting them with four pieces of fishline about 12 feet long, these being fastened equidistantly around each hoop. Beginning at one end, the wire is wound around in the form of a spiral, the turns being fastened each time they cross the fishlines. Twenty-five turns spaced 6 inches apart will give excellent results. The chief advantage of the spiral lies in the fact that it is collapsible, being only a coil of wire and two brass hoops when folded.

Grounds

Grounds have never received enough attention, either by the Radiophan or Radio publications. A man will erect a wonderful aerial, will put in large expensive insulators, will bring the lead-in through a porcelain tube in the wall—and then hastily twist a piece of wire around the radiator valve for a ground. The aerial and ground are both in the same circuit—with the capacity between aerial and ground they form an oscillating circuit—and one should receive as much attention as the other.

The gas pipe should be avoided as a ground as there may be rubber hose connections in it somewhere. The radiator frequently makes an excellent ground, but

tion of all is the grounded side of the electric light circuit. To connect onto this, some care should be used and the following test made. Take an ordinary



Figure 56—The spiral as applied to use on a motorboat is equally good on an automobile

one cannot be certain that it is the best available. The water pipe has always been considered the best place to connect

electric lamp bulb intended for use on 110 volts and twist a piece of heavy bare wire (bell wire with the insulation removed will do) around the threaded base. (Continued on page 20)



Figure 57—The spiral elevated by a kite for use with portable sets

the ground lead, and has proved itself better than either of the other two. It will be found that the best connect-

Infinite Adjustment



DESIGNED to permit infinite adjustment of currents used in vacuum tube. Gives absolute control of electronic flow and finest tuning possible. Fil-Ko-Stat will bring in DX you never heard before and shut out noise.

30 ohms full resistance. No adjustment to puzzle. No discs to break. No Carbon Powder.

2 AT ALL DEALERS

FIL-KO-STAT

Made and Guaranteed by DX Instrument Co., Harrisburg, Pa. Radio Stores Corp., 218 W. 34th St., New York Sole International Distributors

SUPER VALUES

WHAT'S NEW IN RADIO? HAZELTINES NEUTRODYNE

The ultimate receiver for local and long distance Radio concert reception

THE MOST TALKED ABOUT SET OF TODAY

1. SIMPLICITY (A child can operate it)
2. SELECTIVITY (You can tune out local stations)
3. STABILITY (Always ready to entertain)
4. DISTANCE (Average range about 2000 miles)
5. NOISELESS (No squeals, no howls, no whistles)

Complete Parts for Building This Master Receiver \$49.65 AS LISTED BELOW, ONLY

Stock No.	Quantity	Description	Price
201A	1	Bakelite panel, 24x7x1/2, drilled and engraved	6.50
202A	1	Baseboard, 23x6	.75
203A	5	Standard sockets	1.95
204A	3	Neutrolormers	15.00
205A	2	Neutrodons	1.50
206A	2	High ratio transformers	11.10
207A	1	A battery switch	.75
208A	3	4" Pathe dials, taper knob	2.10
209A	1	I Plain rheostat	1.00
210A	1	Fada type 150A. vernier rheostat	1.25
211A	7	Eby engraved binding posts	1.40
212A	1	Closed circuit jack	.80
213A	1	3 spring automatic jack	1.00
214A	27 ft.	Spaghetti tubing	2.10
215A	27 ft.	Bus bar	.25
216A	2	Condensers, .006 mfd.	1.00
217A	1	Grid leak, 2 megohms	.50
218A	1	Grid leak and condenser, .00025	.60
219A	1	Package screws, nuts, terminals, etc.	.10
220A	1	Fada instruction book	.10
			\$49.65

Accessories Necessary to Complete Set for Operation

Stock No.	Quantity	Description	Price
221A	5	Bonded tubes	\$22.00
222A	1	Seaman loud speaker, genuine	12.75
		Baldwin type C unit	12.75
223A	4	Columbia or Red Seal A battery	1.60
224A	2	45 volt B batteries	9.00
225A	1	Set complete aerial equipment	2.00
			\$47.35

OUR SPECIAL COMBINATION OFFER

To each purchaser of the above parts and accessories for the HAZELTINE NEUTRODYNE RECEIVER at the low price of \$97.00 we will, without cost to you, ship a Genuine HANES-ZENER special hand rubbed solid mahogany cabinet. Value \$10.00

Each of the above parts are of the highest standard grade, and carry the HANES-ZENER guarantee and can be purchased separately at our special prices. The Radio Mail Order House Known for Low Prices

Send Money Order, Including Postage

WRITE FOR OUR CATALOGUE B



Natural Re-PRODUCTION



Atlas AMPLITONE LOUD SPEAKER

The radio sceptic, the repeatedly disappointed-searcher after a real loud speaker, is I-N-S-T-A-N-T-L-Y convinced by the Atlas re-PRODUCTION. The patented "double diaphragm" responds to the full range of vibration cycles. Adjustable to your set and to receiving conditions. Ask your dealer for a Demonstration.

\$25

Write for Booklet "R"

What have you accomplished with your Atlas Amplitone? Tell us about it.

Multiple Electric Products Co. Inc. ORANGE ST. RADIO DIVISION NEWARK, N. J.

Radio Digest

Illustrated

REG. U. S. PAT. OFF. AND DOM. OF CANADA

Published by the Radio Digest Publishing Company, Inc.
123 West Madison Street
Telephone: State 4843, 4844, 4845
Chicago, Illinois

E. C. RAYNER, Publisher

Chas. F. Smisor, Editor Evans E. Plummer, Managing Editor
H. J. Marx, Technical Editor M. W. Thompson, Associate Editor

Eastern Representative, Jacob Miller, Times Bldg., Times Square,
New York; Telephone Bryant 4909

Member of the Audit Bureau of Circulations



PUBLISHED WEEKLY

SUBSCRIPTION RATES

Yearly in U. S. and Possessions and Canada, \$5.00.
Foreign postage, \$1.00 additional. Single copies, 10 cents.

Vol. VII Chicago, Saturday, December 29, 1923 No. 12

Announcers at Fault

Many Complaints on Not Announcing Call Letters Plain
SOME time ago we mentioned in this column the difficulty of receiving call letters plainly. There is nothing quite so vexing as to tune in on some distant station, listen for a half-hour to try finding out whom you are listening to, and then find that either no station or call letter is announced, or the letters are pronounced so fast that they cannot be heard distinctly.

If all announcers would at least pronounce the letters plainly and far enough apart so that the last would not run into the following one, it would be some improvement. The frequent giving of the call letters is much desired.

Recently some station announcers do not give call letters at all. This is to be deplored. Most of the enjoyment of Radio reception is in knowing whom you are hearing and who is giving the concert.

Story Stock Must Be Plenty

After-Dinner Speaker Must Guard His Talk

AFTER-DINNER speakers have had to change somewhat the quality of their short stories because they never know who is listening in when a microphone stands on the banquet table.

The professional after-dinner speaker now has to have a larger stock of stories since Radio sends words through the air. While those at banquets may differ, the Radio audience is nearly the same each evening, so one set of stories will not go for the entire season.

To control extemporaneous utterances of speakers, who forget a microphone is in the room, is one problem of a broadcasting station. The censor of a Radio-telephone station must act quickly because the speed of electricity carries the speaker's words into the ether before a button can be pressed to stop him. The Radio audience is so large and represents such a varied interest that the censor must eliminate anything which might hurt the sensibilities of those who are listening. Offensive statements, incorrect grammar, unauthentic statements, libelous and misleading phrases must not be allowed to enter the microphone.

Junk Interfering Spark Transmitters

Write Congress to Make Boats Modernize Equipment

INTERFERENCE! The word that is the bane to all Radiophans. Why cannot it be reduced? Upon careful investigation Radio Digest finds that eighty percent or more of all interference comes from lake, gulf and ocean-going vessels operating spark transmitters on wave lengths entirely too close to the broadcasting range of frequency bands. In other words, the spark sets of the boat stations create more than four-fifths of the trouble the average listener has in attempting to eliminate code "dit-dahs" when he desires to tune in broadcasting stations having wave lengths near 300, 450 and 600 meters.

Who owns these peace disturbers and why don't the owners install tube transmitters whose emitted waves are sufficiently sharp to be tuned out? The Radio Corporation of America, Independent Wireless Telegraph Co., Shipowners' Radio Service, United Fruit Co., Federal Wireless Telegraph Co. and the United States Navy are the chief disturbers. Many of these are earnestly making an effort to stop the disturbance by installing tube transmitters. Others are supposed to be keeping the major part of their traffic out of the regular evening broadcasting periods. But still some of the boats are creating a lot of interference that is blamed by the novice on the American amateur transmitters and other possible sources really not causing the trouble.

Let us urge Congress to pass a comprehensive amendment to the Radio regulations that will raise commercial station wave lengths above possible overlapping on the broadcasting range, and that will make it necessary for all commercial (and amateur) stations to junk their spark equipment and use continuous wave tube transmitters within a period of six months or a year.

We can shout all day on this subject without getting a reaction, but it is the duty of the Radiophan, individually and collectively, to write his congressman and senator at Washington on this subject. Congress makes the laws. Write to the lawmakers!

RADIO INDI-GEST

The Cure of Old Man Flack



Beset with ills was Old Man Flack,
Going for pills from quack to quack.
He took all told a peck or more,
But his insides were just as sore.
Then he became a Radiophan,
As crazy about it as any man.
Sat up listening nights so late,
He lost near half his normal weight.
He read of a doctor out West,
Who had a cure that beat the rest.
Shootin' current through a man at night,
Would stop his pain and make him right.
Flack had a set and felt real sure,
That was the way to make a cure.
He pondered long. A test would tell.
With quacks and pills he'd ne'er get well.
From the antenna a wire he led,
Over, across and straight to his bed,
And while enjoying sweet repose,
The end was twisted 'round his toes.
'Twas dead of night—their came a flash,
Then a terrible, deafening crash.
The house shook with rattle and roar—
Alas, Old Man Flack was no more.
There is a bright side to all things.
Old Man Flack, with his golden wings,
Now tunes in on a perfect set,
But harp music is all that he can get.

H. K. C.



No, F. W., 'Twas an Ash Receiver

Dear Indi: With reference to the following item I clipped from the Chicago Tribune, will you please advise me, through your column (if there happens to be space), whether or not this "receiver" was one of those Stebbins Stupid Degenerative sets, as I don't care to go any further with the construction of my Stebbins, if it is going to be dangerous.

Boy Accidentally Shoots Girl He Asked for "Date"

Brazil, Ind.—Susie Mishler, 17, high school girl, lay near death today from a wound accidentally inflicted last night by a receiver in the hands of Albert Johnson, 17, of Clinton.

Submitted by F. W. REINHARDT.

Get a Job as a Cashier

Dear Indi: Would like to test Milo in a cage, but I can't coax the bird to lend it to me.
What shall I do?

BAKD LITE.

Visions of the Radio Man

(Part II. Conclusion.)

"This is the good ship Albatross
At the bottom of the sea.
All are dead men here on board
With a dead man at the key.
At the stroke of twelve our ship was lost
She slipt beneath the wave,
While I sent our call for all to hear
And none to come to save."

"What tale is this?" cried the Radio man,
His hand cold on the key,
"And who are you that you should joke
Of dead men under the sea?"
The spark came back "O mortal man,
The story is naught but true.
List to my message, believe if you can,
Until my tale is through."

"We killed our masters and took the boat,
Their red blood stained the sea.
The captain was murdered asleep in his bunk
And the deed was done by me.
And here we have waited for months and years
Till one our call should hear.
You are the one who sets us free;
The time we may go is here."

The dawn crept in and found him there,
His form relaxed in sleep.
Today he hears no more the call
From the death-ship in the deep.
He tells his tale to those who'll hear
And swears that it is true.
I'll tell it as he told it to me
And leave the solution for you.

J. A. BIERS.

Huh, You Didn't Pig-Tail Your Souper

Hello Injl: Me China boy. All time like listen to Ladio. No can do. Me lead you papel. See how can do. Build-um one Supel-Degenerative all samee like you say. Him look fine. Got-um wile up in sky. Get-um wile in glonud, all samee like you say. Him fake! No can get Ladio. No sing-um, no Jazzee. No can do. No get soup, but have-um loaf pig me catch-um squealee. No good. You pay me dollah? Good-by.

KUP LING.

How Can He "Think"?

Dear Indi: I know a guy so dumb that he thinks—
—the batteries are "the A-B-C of Radio."
—the one-step amplifier is a dance.
—you have to call a plumber to fix a grid leak.
—Radio stores sell "The Smart Set."
—you can clean your rugs with a vacuum tube.
—a crystal set is to be bought in glass ware stores.
—you have to put bait on a wave trap.

A+B—

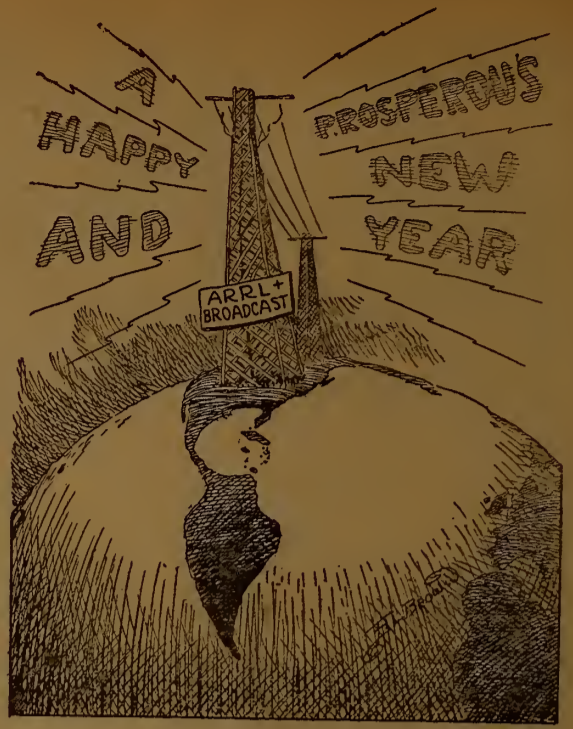

Condensed

By DIELECTRIC

It is to be hoped that in broadcasting the President's address to Congress a precedent has been established which will bring official Washington and all citizens of the United States much closer together. Co-operation among broadcasting stations, such as existed in this instance and that of the Harding memorial address, makes for a warmer feeling between listeners in and the stations for the reason that consideration is highly regarded—but too seldom practiced. Perhaps it would tend to kill interest in Radiophony should the United States Senate undertake to transmit its sessions over the ether, yet verbosity, irrelevance and subterfuge would surely take flight in the face of the microphone.

I may be severely criticized in many quarters for keeping up a persistent reference to that class of music dubbed by some as "high brow," "dry and uninteresting," but results so far only serve to encourage me to further effort. Not long ago, WIP in Philadelphia gave to its listening audience a program of classical music which was so heartily appreciated as to elicit comments from eighty percent of all those writing to the station; the other twenty percent expressed interest in features of a lighter nature. If the letters received by each station could be tabulated, I am willing to wager a large proportion of them would bear kindly reference to classical productions. What was the result of the census taken during the annual Radio show in Chicago? This should provide data of great interest.

WNAC has a happy faculty of hitting upon programs of fairly universal appeal. On two occasions recently the directors of this station in Boston broadcast what to many seemed worthy of their ideals, which remained set for the low wave length during the two periods. The first was a musical program including numbers by the Harvard mandolin club and the Harvard banjo club, the latter playing football songs with their thrilling appeal to fans of the gridiron. Then came an evening of unique features in the broadcasting of the famous Clover Club Ladies' Night dinner from the Shepard Colonial Restaurant, and if variety is the spice of life, then Major Fanning was far from short on spices.

A year ago an especial appeal was made to those giving Christmas gifts to include Radio receiving sets and units among the items on their lists. The suggestion was acted upon by so many shoppers as to greatly increase the sales of Radio products all over the country, bringing many into the ranks of Radiophans whose procrastination had deprived them of unlimited joy theretofore. Again, this year, it was to be a Radio Christmas—and it was! Less time has been wasted trying to decide the proper gift for friend or relative since Radio broadcasting came among us, and the recipients of sets, tubes, speakers, etc., have never thought for a moment of how much better they might have chosen, as sometimes was the case in the past.

There is no question but that a large majority of the American people find much of their entertainment in some form of dancing. I say "some form" for the simple reason that certain styles of jumping and stumbling about a room with an accomplice is all too frequently seen—and these semi-acrobats are "dancing!" WOR, the popular Bamberger station in Newark, N. J., was the first to secure the excellent services of Arthur Murray as instructor to Radio audiences in the real art of dancing. A number of other stations have availed themselves of the use of Mr. Murray's skillful tutelage with the hopeful prospect of changing to graceful dance movements what is at present vigorous exercise.

Latest Development in Grimes Inverse Duplex

Part VI—Tuned Radio and the Inverse Duplex

By David Grimes

BEFORE the years 1913-1914, Radio frequency amplification was absolutely a closed book. No one had any idea of amplification of Radio signals before detection. All the amplification was being performed in the audio branch of the circuit. This, of course, had its limitations because a detector device will refuse to function when the incoming energy drops below a certain minimum value. An amplifier tube, on the other hand, will pick up much weaker signals and will, in turn, amplify them. By a sufficient number of such Radio amplifying tubes, a signal many times too weak for detection could be brought up to the proper value to operate the detector tube. This system of amplification before detection was introduced in this country by the U. S. patent number 1,087,892 granted to Schloemilch and Von Bronk. This veritable broadside covers not only Radio frequency amplification, but also tuned Radio frequency and reflex as well.

Tuned Radio Frequency

From then on for the next few years, tuned Radio frequency amplification was the only known method. A fixed untuned Radio transformer was thought to be an impossibility. And so we see the progress of the art clearly revealed in patent number 1,173,079 granted to Alexanderson. This patent shows a series of tuned Radio frequency amplifying tubes—an extension of the Schloemilch idea which only disclosed one Radio tube. These multi-stage tuned Radio circuits had a tendency to oscillate and, in general, were quite unstable. This was particularly so with certain types of tubes when high efficiency amplification was attempted.

And then came Chester W. Rice, who made a thorough study of the Alexanderson system of multi-stage tuned Radio frequency circuits. He admirably ferreted out the cause of the oscillations in such circuits and prescribed the remedy. This he has clearly shown in U. S. patent number 1,334,118 filed in 1917. He describes the oscillations as due to the inherent capacity coupling between the grid and plate in the vacuum tube itself. This causes a feedback from the plate circuit to the grid, resulting in regeneration and oscillation. He gives the general remedy by using a second path of feedback from the plate to the grid in such a manner as to oppose the original feedback and thus neutralize it. He employs both neutralizing transformers and neutralizing condensers. Some improvements have lately been added to this arrangement, notably those of Lester Jones and more recently those of Professor Hazeltine and Mr. Wheeler.

Untuned Radio Frequency

When the broadcasting boom broke out in 1921, it was realized that if Radio fre-

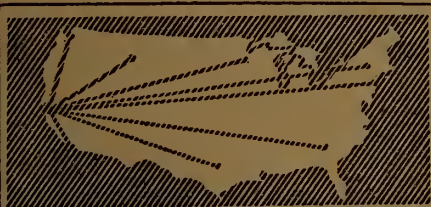

ON ONE TUBE

Broadcasting from Atlantic Coast, Mexico, Hawaii, Canada and Cuba heard in California by users of CROSS COUNTRY CIRCUIT. Range due to simplicity of set and only one tuning control. Easily and cheaply built by any novice. Dry cell tubes may be used. All instructions, blueprint panel layout, assembly photo, etc. Postpaid, 25c. Stamps accepted.

VESCO RADIO SHOP
OAKLAND, CALIF.
Box D-117

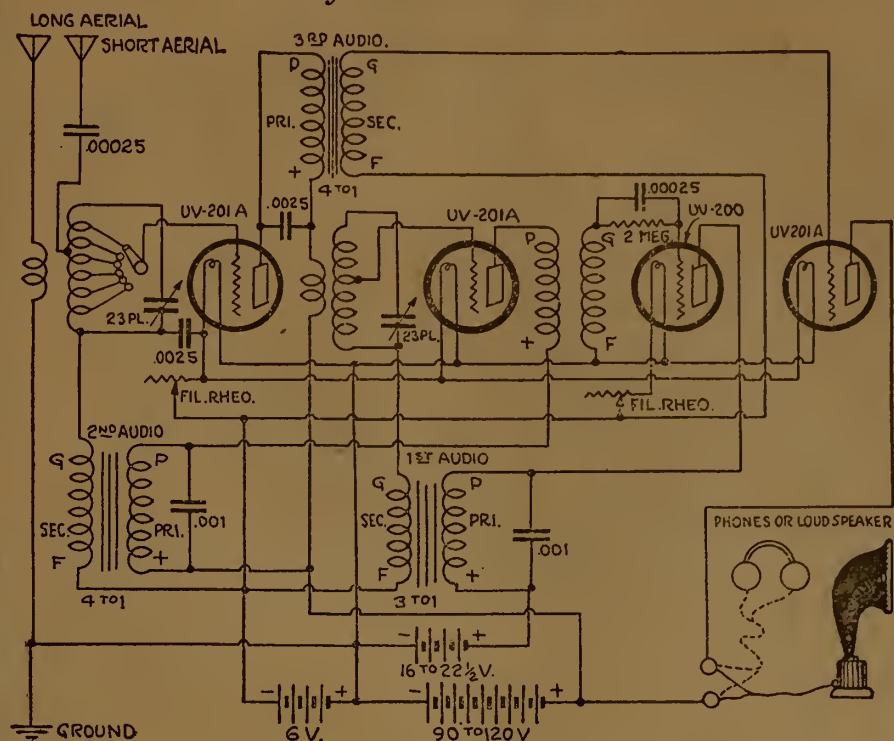

Figure 14—Tuned Radio and the Grimes Inverse Duplex

quency amplification was ever to become popular, it would be necessary to develop an untuned fixed Radio frequency transformer. In this way only could the excessive number of tuning controls be reduced to a practical arrangement, that could be operated by the ordinary enthusiast. Most of the Radio frequency geniuses started at once to produce such an instrument and, as a result, several highly successful types of fixed transformers are now on the market. This was heralded as a great step forward in Radio frequency development and it was this development alone which first made Radio

frequency possible and popular with the public.

Recently, however, there has been a tendency on the part of some of the Radiophans to drift back into the tuned Radio circuits. This is caused by the fact that some of us live very near some high powered Radio broadcasting station. Such a station is difficult to tune out with only one tuning control, and if we desire to hear the more distant station while that local one is on the air, we will be forced to employ more tuning controls at the sacrifice of simplicity. But let it be said right here, that tuned Radio is not the

panacea, or cure-all, for Radio troubles. It has certain advantages when one is located under the eaves of a high powered broadcasting station. Otherwise the many tuning controls become a nuisance and are not required. The criticalness of operation makes the tuned Radio circuit impractical for loop reception, and therefore, being decidedly an aerial arrangement, it is subject to telegraphic code and static interference, in spite of its fine tuning.

Combination Tuned and Fixed

The field, then, for tuned Radio is that territory within a five-mile radius of a high powered broadcasting station, and it is for this class of reception that the set described in this article is recommended. Even then, the set is a compromise between tuned and fixed Radio. Two stages of tuned Radio would ordinarily require three tuning controls—the input into the first tube, the input into the second tube, and the input into the detector tube. Unfortunately nature has not supplied us with three hands with which to operate three such controls. Accordingly, I have made the input into the detector tube a fixed coupling or fixed transformer. This

(Continued on page 20)

NEW EASY WAY

To Get Real Long Distance

Ashe variable Grid Leak (Patented) gives a smooth, positive contact—automatically renews graphite path—greater capacity than any other leak. Super sensitive control assures perfect results from Ultra Audion, Flewelling, E. C. S., or any regenerative receiver. Test one on your own set. Just send name and address. Deposit \$1.40 (plus postage) with Postman. Cash in full with order, postage prepaid. If, after ten days trial, you are not delighted, money back quick. You see you take no risk, so send name and address at once to Lucken Radio Sales Co. Dept. 7 501 S. Dearborn St., Chicago

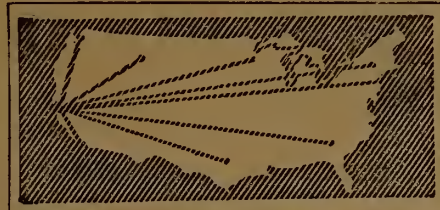

ON ONE TUBE

Broadcasting from Atlantic Coast and Cuba heard in Calif. by users of the CROSS COUNTRY CIRCUIT. This range due to simplicity of set, and operation by one tuning control. Easy and cheap to build by any novice. Dry cell tubes may be used. Complete understandable instructions, full size blue print panel layout, assembly photo, etc., postpaid 25c; stamps accepted.

VESCO RADIO SHOP
Oakland, Cal.
Box D-117

ECONOMICAL

The Magnatron draws only .06 amps. at 3-4 volts

STANDARD

The Type DC-199 Magnatron lists at \$6.50

MAGNATRON

The Tube That Makes Local Stations Louder and Brings Distant Stations Closer

A set of dry cells lasts months! The guaranteed filament current of .06 amperes makes certain of that—and makes it possible to use three Magnatrons on an ordinary flashlight battery or else on three dry cells.

Capacity effects, so detrimental in radio frequency circuits, are eliminated by the all moulded Condensite base—without brass shell. No adapter is needed for standard sockets.

Go to your nearest dealer and have him show you the Magnatron, or the Melotron (the quarter ampere dry cell tube that is making records).

If your dealer cannot supply you we will ship either tube at the special holiday price of \$5.50 if you include your dealer's name.

DEALERS: Write for attractive propositions!

CONNEWAY ELECTRIC LABORATORIES
309 Fifth Avenue NEW YORK CITY

B

LOUD TALKING CRYSTALS 50c

RADIO CRYSTAL

B-METAL TUBE DETECTORS \$1.50

Have stood the test of time and are best by every test.

At All Dealers and Jobbers
B-METAL REFINING CO.
3134 Trumbull Ave., Detroit, Mich.
Chicago Branch, 53 West Jackson Blvd.

C RATED DETECTOR

SPIDER WEB HOOK-UP SIMILAR TO THE MILOPLEX

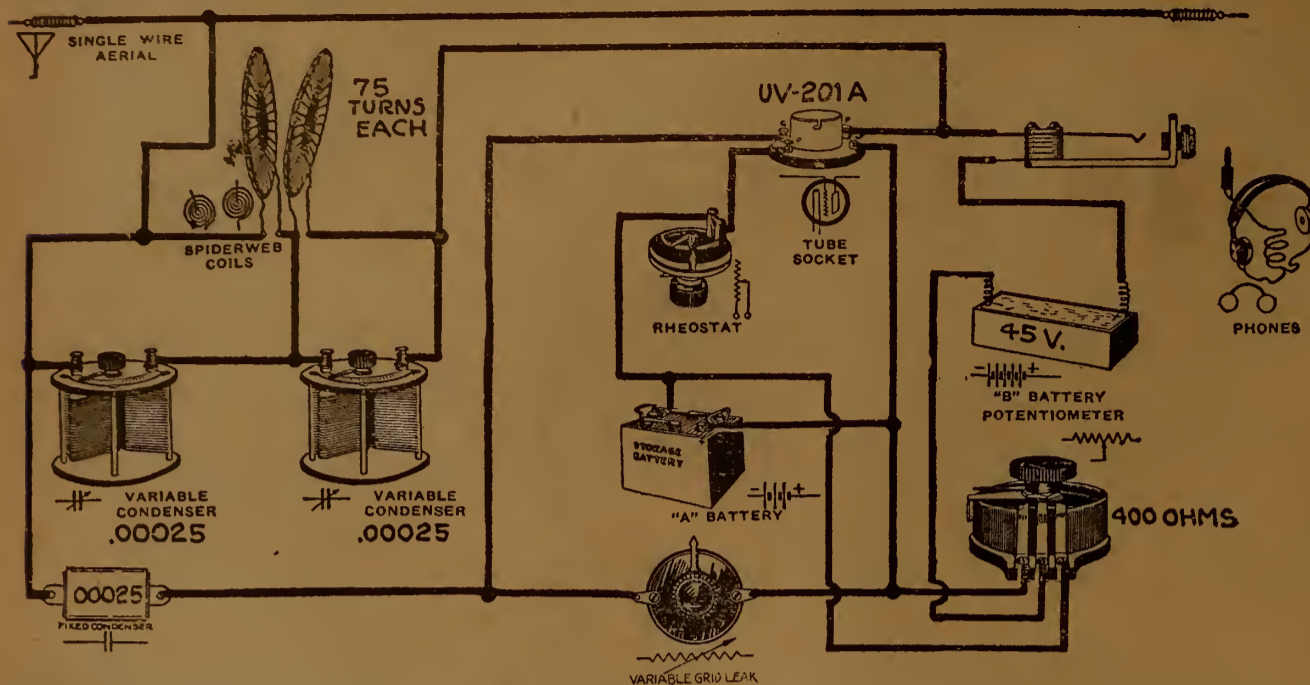

SOME experimental work in the laboratory developed the circuit illustrated. Unfortunately, after looking over that latest Miloplex we are anticipating that that Mystery Man is going to tell us, "Old stuff, you copied my latest circuit." There is no question or doubt but what the circuit is very similar, but what's the difference? Try it and have your fun with it.

Two spider web coils are both wound with 75 turns of wire. The frame should be the same size in each case, and the two variable condensers must be of the same capacity. A slight variation from the circuit presented is to substitute a variable grid condenser of the same capacity in conjunction with the variable grid leak. A UV-201A tube is used with a 45-volt

plate battery and the potentiometer has a resistance of 400 ohms. The coupling adjustment between the two spider web coils is apt to be very critical and therefore some form of vernier control is recommended. Vernier plates on the variable condenser are not necessary, although some form of vernier control of the dial will be found of decided value in tuning.

KING MILOPLEX

(Continued from page 11)

Note particularly that this innocent baby on one tube traveled from Buffalo to California and stopped off at Kansas City on the way; so if some of you curious fans will look up the exact location of Rokeby, methinks you will say it's a good enough circuit to cause you to send Maggie a postal card.

And there's another big idea back of all this; listen!

Now that winter has forced me into the bathtub when I can remember which is Saturday night. I'm going to stick together a little reflex trick, take it up as far north as the Canadian railway will let me ride on last year's pass and give it a chance to step out. 'Tain't exactly a new reflex circuit—well, maybe it is too—but it has a couple of "common horse-sense" ideas in it that will probably cause a few engineers to sit up and take nourishment.

And it's going to be all yours for only a dime. Five hundred postal cards to Maggie; say, boy, I know you'll send her 2,000 and make her love her King. Atta baby! Start them coming now after you have looked over the log of the loop. If it looks good send the card and I'll do the rest. Let's eat.

(TO BE CONTINUED.)

Testing Condensers

Test your condensers. If you can squeeze them, they are probably poor. If the plates of your variable condensers are of thin, paperlike aluminum or brass, there is a great chance that the entire condenser is poor. Variable condensers should have sturdy-looking plates, well-made or pressed spacers, machined bearings and uniform spacings. A condenser is made for hard use, probably harder and more constant wearing use than any other part of the apparatus, so get one that is sturdy.

Concerning Condensers

In selecting variable condensers make sure that there is no lost motion between the shaft and the bearing, and that the provisions for panel mounting, if of that type, are suitable for the thickness of the panel in your set. To test a condenser for short circuits, connect the filament lighting battery across the two binding posts on the condenser and then rotate the movable plates. Sparking will indicate when and where the plates touch.

Radio Operators

Sea-going Radio operators are greatly in demand today. According to the U. S. Shipping Board officials a shortage of Radio operators to man both government and private vessels, exists and steps are being taken to make these positions attractive to licensed men. The shipping board is co-operating with the department of commerce to obtain the desired operators. The wages of government operators were recently raised 15 percent.

Radio Circuits

The most popular American Radio Circuits

50 Diagrams and Illustrations

Price Only 50¢ each

Send Only Money Orders, No Checks or Stamps. Come at Your Own Risk.

Radio Digest Publications
125 West Madison St. Chicago

CROSLY MODEL X-J RADIO RECEIVER

\$65

Tune Out Local Interference

ENJOY the many interesting programs that may nightly be received from distant broadcasting stations.

With a Crosley Model X-J you can easily do this. This 4-tube radio receiver, consisting of one stage of tuned radio frequency amplification, detector and two stages of audio frequency amplification, is daily making new distance records.

Unsolicited letters from all parts of the country tell us of the farthest distant stations being brought in clearly and distinctly.

You, too, can enjoy the best programs if you own a Crosley Model X-J—Price only \$65.

Under actual tests, it has proven that for bringing in distant stations no set can excel it.

For Sale by Good Dealers Everywhere

Crosley Manufacturing Company
POWEL CROSLY, Jr., President
12495 Alfred Street, Cincinnati, O.

FIRST TO DELIVER THE NEW ALL-AMERICAN PUSH PULL Transformers

DISTORTION ELIMINATED

List \$6.00 ea. \$12.00 pr.
Immediate Shipment

Dealers Write

C.W. Thompson Company
JOBBER ELECTRICAL RETAILERS
Mattoon, Illinois

Why WINK YOUR SET?

The new TWITCHELL AUXILIARY TUNER connected to your present set will enable you to bring in the long and short wave stations which your present set cannot get. It also cuts out all local stations so you may bring in distance any time without local interference. Copyrighted diagram of this tuner 50c, or with all parts \$9.00. Complete instrument in walnut cabinet, ready to use, \$15.00. Transportation prepaid.

MY HIGHLY IMPROVED REINARTZ brings in all important stations on this Continent loud, clear and without distortion. We dance to music from Atlanta and Los Angeles.

Build one of these wonderful 3 tube sets from my blueprint and specifications, price 50c, or with a complete and perfect double-wound spiderweb coil \$3.00 by mail. Picture of this set on a glass panel with every order. This copyrighted circuit is the most successful of any Reinartz modification yet produced, and is limited the most. Thousands are in use. My W. D. H. Circuit is especially designed for use with the "Pickle" tube and brings out the full value of that little tube as no other circuit can. Stations 1000 miles away come in clearly on one tube. This set is small, complete, portable. For the man who wishes the highest efficiency, this is the set to build. Price of blueprint and specifications, 50c, or with complete and perfect windings, \$3.00. Photo of set with every order. Sets built from these copyrighted plans will receive all broadcasting stations operating under the new laws. Their wave length range is from 170 to 800 meters. All goods prepaid. These instruments are easy to build, easy to operate. Everything clearly shown.

S. A. TWITCHELL
1925 Western Avenue Minneapolis, Minn.

VOLTRON TUBES

SAVES YOU \$1 ON EVERY TUBE

High quality, rigidly tested vacuum tubes—every type—equal to the best for a dollar less. Absolutely efficient. Every Tube guaranteed. If not satisfactory money promptly refunded.



Type	B Battery ALL ONE PRICE Voltages
OH-12, 1 1/2 V., 25 amp.,	15 to 90
OH-501A, 5 V., 25 amp.,	15 to 90
OH-599, 3 V., .06 amp.,	16 to 45

\$5.50

If your dealer hasn't these new tubes, send us his name and your order direct. Mailed C. O. D. Buy Voltron tubes and use the dollars you save for other parts. Order before you forget—RIGHT NOW!

O. HERSCHKOWITZ, 92 Branford Place, Newark, N. J.
Dealers and Jobbers—Write for attractive proposition.

FORMICA

A Laminated Phenolic Condensation Product

SHEETS TUBES RODS

RADIO PANELS

POLISHED BLACK FINISH

CUT PERFECTLY SQUARE TO ANY SIZE

1/32" THICK	1/2¢ PER SQ. INCH
1/16" THICK	3/4¢ PER SQ. INCH
3/32" THICK	1¢ PER SQ. INCH
1/8" THICK	1 1/2¢ PER SQ. INCH
3/16" THICK	2¢ PER SQ. INCH
1/4" THICK	2 1/2¢ PER SQ. INCH
3/8" THICK	4¢ PER SQ. INCH
1/2" THICK	5 1/4¢ PER SQ. INCH

SEND FOR COMPLETE PRICE LIST PROMPT ATTENTION TO MAIL ORDERS DEALERS PRICES ON APPLICATION

STARRETT MFG. CO.
519 SOUTH GREEN ST. CHICAGO

Simple and Efficient Honeycomb Coil Circuits

Part I—Kinds and Types of Coil Windings

By H. J. Marx

IT IS a well-known fact that the familiar form of single layer tube wound inductance dates farthest back in the development of Radio apparatus. Its particular disadvantage was the unnecessary large space it occupied. As a result the bank winding, spider web winding and honeycomb coils followed shortly afterwards. Each has its distinct advantages and likewise its disadvantages. Spider web coils for a long while became purely a home construction product. In addition, when two or more circuits were to be closely coupled, it became necessary to wind all on the same form. In most cases the tuning of each circuit was accomplished by means of taps or variable condensers. The dead-end losses in tapped coils are quite apparent. If a variable coupling was necessary it was found that the efficiency of the coupling decreases as the number of turns on the coils is increased. This is due to the fact that the



Figure 1

outside diameter becomes too great, producing a piece of apparatus that again gets back to the old difficulty of too much space requirement.

A GOOD CONDENSER

(Continued from page 9)

will be the one with which it was necessary to use the smallest amount of regeneration. Self-evident, isn't it?

Capacity Effect Also Factor

In general, too, it will be found that with an equal amount of shielding for each condenser, the condenser which shows the smallest amount of hand capacity effect will be the condenser having the smallest amount of stray fields and hence, the condenser having the smallest amount of losses due to this cause.

The above are of course only comparative tests, but if they are carried out with ordinary care and under the same conditions, you may be very sure that the condenser you pick is the best one in the lot under test, and that you can rely on its quality and its performance in any Radio circuit or set you contemplate building.

Influence of Short Waves

Short waves such as 300 meters down to 100 meters are very fussy about the condenser used with them. Many con-



Figure 2—Inside triple coil mounting

Bank Winding

The old form of bank-wound inductance produced an efficient coil but was found to be a difficult and expensive manufacturing proposition. For this reason the production of honeycomb coils followed the natural sequence of popularity. There have been a considerable number of changes in the method of winding. The custom of running the wire diagonally and crosswise from side to side is still adhered to but a further development has been the addition of a layer of material between successive windings. This has consider-

ably reduced the internal capacity of the inductance and thus appreciably raised their efficiency.

Panel Mounting

When first developed it was quite natural to assemble the mounting for the honeycomb coils on the front of the panel because of the required accessibility for changing the coils for different wave length ranges to be covered. The public at the present time have overcome the initial impression that Radio is simply a new marvel and that they were lucky in getting what they could. They have

reached the stage where quality and efficiency are demanded and received, and are even going a step farther and expect additional factors such as tone quality, neatness of appearance and efficiency in constructional design. The front of the apparatus must show no bulky parts and require no unsightly wires, but should be pleasing to the eye and retain only the essential controls. This, then, killed the old form of front panel coil mounts. Another factor was the problem of capacity effects created by placing the hand on the knob (very close to the coils) which controlled the coupling of the coils.

For quite a time nothing was done to supply the demand for an inside coil mount. Now, however, there are two or three different makes on the market, one of which is shown in the illustration. It has another good feature, in that the gearing gives positive action and the arrow on the knob at the same time indicates the relative position of the coils. The result is a panel mounted piece of apparatus in which only the two control knobs show.

Another Inductance Form

Another highly efficient form of inductance, similar to and used like the honeycomb coils, is that shown in Figure 1. This form of winding is practically a self-supported spider web coil without the bulky and awkward form commonly used in the home constructed article. This form of coil is highly efficient and inexpensive. Although there are no standard units for mounting with variable coupling, a number of manufacturers are making different types of special tuning units utilizing this type of coil in an efficient and satisfactory manner. Some illustrations of this special unit will be shown in later parts of this series. This form of unit can be substituted with as good, and often decidedly better, results in any of the standard honeycomb coil hook-ups. Details on some special form of mounting for the amateur to make will also be given later.

Special Miloplex

There have been numerous demands for Miloplex circuits with honeycomb coils. (Continued on page 20)

densers are not able to handle 100-meter work at all. Radio frequency and reflex circuits, too, are in a similar class and many a set has failed to give the anticipated results simply because the tuning condensers used had too many losses of one kind or another in their makeup.

Number of Plates Not Essential

The range over which we can tune our set with a given condenser does not, as so many seem to believe, depend upon the number of plates in the condenser. It does not matter, particularly in the broadcasting range, whether our condenser has 43 or 11 plates, so far as what range it

will cover is concerned. We might be able to tune from 250 to around 600 meters with a given coil and no taps, using the 11-plate, and only be able to tune from 300 to 500 meters with the 43-plate condenser. Our ability to tune over a big range with a given condenser depends upon how small the zero reading of the condenser is in relation to its maximum reading or capacity. That is, if one condenser has a capacity at its zero setting, plates all out, of 1 mfd., and a maximum, plates all in, of 10 mfd., for the sake of round numbers, it will tune over

(Continued on page 20)

KELLOGG RHEOSTATS



Very accurate!
for sharp tuning
for simplicity

Now stand by men and let me tell you something about this Kellogg Rheostat that you have been hearing about. **FIRSTLY**—the long contact surfaces gives you a perfect contact under all conditions. **SECONDLY**—to assure perfect current to the most critical tube this baby gets into action on the half turn of the resistance element. **THIRDLY**—you can look it over carefully and you will find only one moving part—that's for simplicity.

If you want your little outfit to be the "Pride of the Neighborhood" just remember that good rheostating has a whole lot to do with good receiving. We have a price, yes. It's \$1.50.

Use is the Test

KELLOGG SWITCHBOARD & SUPPLY COMPANY CHICAGO

IF YOU CAN'T BUY THEM AT YOUR DEALER'S SEND DIRECT TO US

"Red-Heads" are guaranteed radio phones. You run no risk when you buy them. Money back if, after 7 days' trial, you're not satisfied that they're the best receivers on the market at the price. Why not act right now and get a pair? It'll mean getting the maximum from broadcasting from the day you put them into use.



RED-HEAD RADIO RECEIVERS

These remarkable head-sets are made by The Newman-Stern Co., one of the pioneer radio manufacturing houses in America.

JUST OUT

The new 1924 Model F
\$6.50 PER PAIR Complete

The new 1924 "Red-Head" Jr.
\$5.00 PER PAIR Complete

This is the standard 3,000 ohm "Red-Head." The 1924 Model F has eleven improved features. Sensitive and fine-toned; aluminum case; famous brown-red ear caps; military headband; high-grade cord.

The Junior Model has most of the quality features of the standard Model F here described. The resistance is 2,000 ohms per set instead of 3,000 ohms. A remarkable value.

"Red-Heads" sent prepaid on receipt of price if you are unable to get them at your dealer's.

THE NEWMAN-STERN COMPANY
Dept. RD Newman-Stern Bldg. Cleveland

KEYSTONE

RADIO LIGHTNING ARRESTERS

\$2.00 **\$2.00**

Should be on every aerial the year 'round. Provides highly efficient lightning and static protection for the home. Fully approved by Fire Underwriters. Can be installed outdoors. Has no vacuum to lose. Install one in your aerial lead now—be safe.

This pioneer radio arrester is backed by 31 years' experience in lightning arrester design.

For sale by Dealers everywhere, or sent postpaid for \$2.00. Write for circular.

Electric Service Supplies Co.
17 & Cambria Sts. Philadelphia
Monadnock Bldg., Chicago
50 Church St., New York

Build Your Own EASY

Full Details Blue Prints

Reflex De Luxe

THREE TUBE RECEIVER
FULL DETAILS FOR ASSEMBLY
BLUE PRINTS
TUBING DETAILINGS
HOW TO MAKE A LOOP AERIAL DELUXE

Miloplex

THREE TUBE RECEIVER
DETECTOR AND TWO STAGE
AUDIO FREQUENCY AMPLIFIER
ASSEMBLY DETAILS
TUNING INSTRUCTIONS
BLUE PRINTS

Neutrodyne

FIVE TUBE RECEIVER
TWO R. F. DETECTOR, TWO A. F.
ASSEMBLY DETAILS
BALANCING OPERATIONS
TUNING INSTRUCTIONS
BLUE PRINTS

Price only 50¢ each

Radio Digest Publications
123 West Madison St. Chicago

RADIO DIGEST PUBLICATIONS
123 W. Madison Street, Chicago, Ill.

Check Bank Desired

REFLEX DeLUXE 50c
 MILOPLEX 50c
 NEUTRODYNE 50c

I am enclosing M. O. for \$.....

Name.....
Address.....
City..... State.....

H. C. COIL CIRCUITS

(Continued from page 19)

As this circuit is especially sensitive to losses, the type of winding shown in Figure 1 will be found to give considerably better results. This special Miloplex is

or 50 turns each for the lower range of wave lengths.

A Simple Hook-Up

A very simple form of two coil hook-up is shown in Figure 4. Two .0005 variable condensers, preferably with vernier control, are shunted across the coils and tune the primary and secondary circuits. The

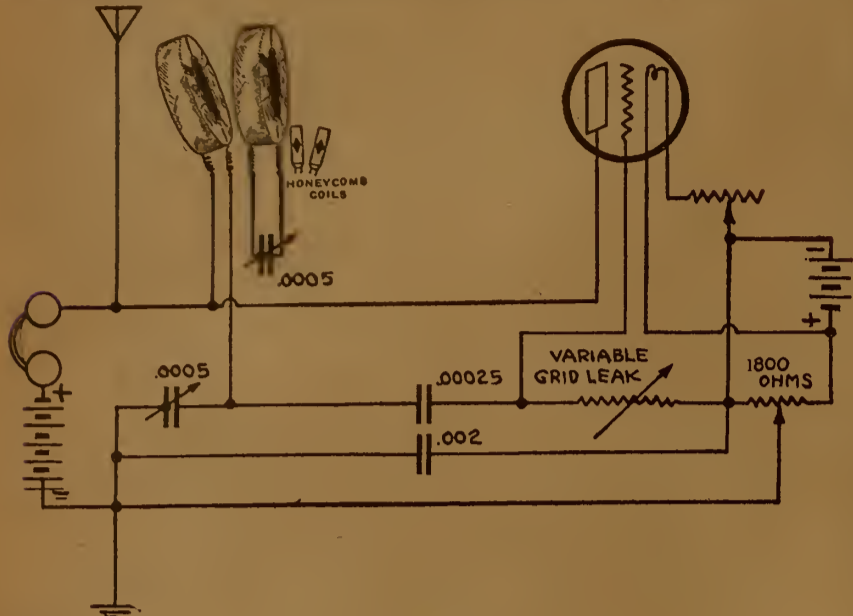

Figure 3

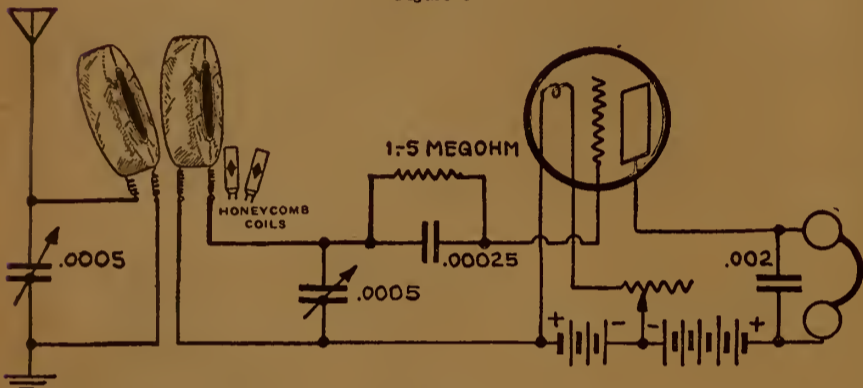

Figure 4

shown in Figure 3. All values are indicated and conform to the specifications given in the Miloplex articles with the exception of the coils, which should be 75 turns each for the normal wave length

circuit is non-regenerative and will be found very satisfactory for local work. The coupling between the two coils must be variable. A detector tube with 16 to 22½ volts on the plate is required.

(TO BE CONTINUED.)

INVERSE DUPLEX

(Continued from page 17)

permits the entire tuning to be accomplished with two hands—the two dials reading practically the same value for a given station. This arrangement of tuned Radio is more reasonable and is entirely excusable, considering the extreme conditions for which it is recommended.

Set Employed Radio Frequency

Referring to Figure 14, it will be seen that the set employs four tubes and is designed to work on an aerial and ground. There are three UV-201A amplifying tubes and one UV-200 detector tube. Other tubes than these can be used, but with nowhere near the same efficient results.

A separate 22-volt B battery is used with the detector tube, as there is generally a likelihood of audio howling when three audio tubes and a detector are operated from the same set of B batteries. This is particularly true if the B batteries have somewhat depreciated. This point will be taken up in more detail in the next article which shows the additional audio

tube added to the previously described three tube loop set. The fixed Radio transformer, between the last Radio tube and the detector, should be one which covers the entire broadcasting wave length band.

The audio transformers should preferably be of a low ratio although no definite rule can be given, as so much depends on the impedance and self-capacity of the primary and secondary windings. A few of the high ratio transformers have worked in this circuit admirably well while others have been failures. Very few of the low ratio types have refused to function properly. An indication of the ratios is given in the drawing, but this is not to be taken as ironclad. The values of the small by-passing condensers come under the same reservations. They are not critical and for best results will vary with the type of audio transformer used.

Two Tuned Radio Transformers

The two tuned Radio transformers or

Perfect Connections

are always sure with

FAHNESTOCK PATENT WIRE TERMINAL

Grips Like a Vise Eliminates Vibrations
Easily Attached No Soldering
Best of All for RADIO OUTFITS

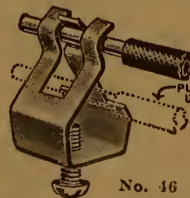

No. 46
Made in all Sizes and Shapes
At Your Dealer's

**Fahnestock Electric Co.
LONG ISLAND CITY, N. Y.**

Dealers can obtain Fahnestock Products from following distributors:
BOSTON—Wetmore-Savage Co.; F. D. Pitts Co.
DETROIT—Detroit Electric Co.
CHICAGO—Barawick Co.
MILWAUKEE—Julius Andro & Sons Co.
PHILADELPHIA—H. C. Roberts Elec. Sup. Co.
PITTSBURGH—Ludwick, Hommel Co.
WESTERN DISTRIBUTORS
Marshall & Co., Los Angeles, Cal.

fixed couplers, are shown at the input to the first and second tubes. The primaries are indicated by a few turns of wire while the secondaries are shown with many turns and a tuning condenser across them. The secondary of the first transformer is tapped about five turns through its entire length. The secondary of the second transformer is tapped in only one place and that is about two-thirds of the way up from the end where the primary is wound.

These two transformers can be very easily made. The first things required are two pieces of 3-inch diameter cardboard, bakelite, or fiber tubing. These need only be about 3 inches long. The primaries and secondaries of both transformers are wound with number 28 d.c.c. wire. The primaries consist of 8 turns of wire wound at one end of the tube. The secondaries are then wound on the tube and each one has about 40 turns of wire, the actual number depending on the capacity of a 23-plate tuning condenser, used to tune the secondaries.

The secondary of the first transformer is tapped every five turns, so that the grid to the first tube may be connected to the proper one for best volume and quality. The short aerial connection is permanently placed on the thirtieth tap. The one tap on the secondary of the second transformer is permanently wired to the grid of the second tube. This tap is at the twenty-sixth turn. This gives sharper tuning and about the same volume as compared with the grid connection being placed on the last turn, as is customary. The end of the secondary nearest the primary, in each case, is wired to the audio transformer.

It is felt that this article will solve your question as to whether you do or do not wish to experiment with tuned Radio frequency. If you do, the information given, while limited, is sufficient to enable the average experimenter to proceed with fair assurance of success. There are many questions which will naturally arise and, obviously, the variations possible in Figure 14 are almost limitless. If there is enough interest evinced in the form of letters concerning the possibilities in the Tuned Inverse Duplex, there will probably be other articles forthcoming dealing with these.

The next and last article of the present series will discuss various precautions necessary in all the arrangements, and particularly those required when a third stage of audio amplification is added. The suggestions forthcoming will be helpful to a large group of Radio enthusiasts who have tried in vain to add a power audio to any and all types of circuits already using two audio stages. The usual difficulties will be shown together with their common remedies.

(TO BE CONTINUED.)

A GOOD CONDENSER

(Continued from page 19)

a much greater range than a condenser having a minimum of 3 mfd. and a maximum of 15 mfd., and it would be better to use it because our condenser should be as small and the inductance as large as possible, particularly in the broadcasting range. An 11-plate condenser with a low zero capacity and high maximum capacity is about as large as should be used for such work.

Briefly stated, of two condensers of the same size, 11 or 43 plate, set at zero, that which brings in the shortest wave is the one having the greatest range. This last assuming that their maximum is the same.

To shield the panel, use only tinfoil or copper foil, never sheet tin or iron.

IMITATIONS

HAVE COME AND GONE

but the

FRESHMAN



Variable Resistance Leak

and Condenser combined, is considered the

STANDARD

throughout the world. It is the most efficient, most compact and the only leak that is entirely sealed and remains unaffected by climatic conditions.

Where the leak is not used as a tuning instrument we recommend the Base Type. In circuits where considerable adjustment is required, the Panel Type is preferable.

EITHER TYPE

Complete with either .00025 or .0005 Freshman Cond. \$1.00
Without Condenser75

At your dealers, otherwise send purchase price and you will be supplied postpaid.

Chas. Freshman Co. Inc.
Radio Condenser Products
106 Seventh Ave. NEW YORK

RADIO FOR EVERYBODY

(Continued from page 15)

Now connect this wire to the cold-water pipe. From your electric light socket bring the two wires out through a plug and keep them carefully separated so that they do not make a short circuit. Holding the bulb in one hand by the glass part, touch one of the wires to the little brass button in the center of the bottom of the base. Then lay that wire down and touch the other wire from the socket to the little brass plug in the bottom of the bulb. Touching one of these will cause the bulb to light; touching the other will not. Use for a ground the one that does not; that is, the grounded side of the electric light circuit. The second wire from the socket should be removed.

However, should the reader not have an electric light circuit available, or should he not care to use it, the cold-water pipe should be used as the next best connection. But you will find its surface corroded and it is essential that this be removed for good results. With a file or a knife scrape off the pipe all around for a length of 3 inches. The lead from the ground post of your set should now be run to this point and a length of wire, about 3 feet long, carefully scraped shiny. Wrap this around the pipe closely and tightly ten or twelve times and solder it.

If it is absolutely impossible to solder the connection, cover it with black electrician's tape.

(TO BE CONTINUED.)

Double Wire on Coil

If you have some wire from an old coil of some sort and want to make a tuning coil but think the wire is too small for this work as it will have too much resistance, two wires may be used if the coil is wound neatly. I find that by winding one wire on one layer and the other on the next, and tapping in on exactly the same lengths of wire, excellent results can be obtained.—J. B. Owen, Blair, Okla.

FREE
Your Choice
of one bound volume with each annual subscription



Radio Digest Illustrated Volume 5
Greatest Collection of Radio Information Ever Published
Reinartz Long Distance Circuit
Ultra-Reinartz Circuit
Flowling "Fliver" Circuit
Grimes "Inverse Duplex" Circuit
Single Tube Reflex Circuit
Armstrong "Super-Heterodyne" Circuit
Two, Three and Four Tube Reflex Circuits
A. B. C. Lessons for Radio Beginners
In addition to these features these volumes contain many instructive articles, receiving set diagrams, how to make articles, new apparatus, pictures and illustrations, hook-up diagrams, broadcasting stations, technical articles and book reviews.

65
Numbers

13 Numbers in the Bound Volume; 52 Numbers in Year's Subscription. Volumes 3, 4, 5 and 6 Now Ready.
Your choice of one Bound Volume is free and postpaid with your one year's subscription or renewal.
This offer good only in the U. S. and possessions. One dollar additional for Canadian or foreign countries.
Additional volumes are \$2.00 each, but are only available to annual subscribers. This on account of our limited supply.
Orders for these Bound Volumes must be mailed us direct with full remittance as they can not be supplied on orders through subscription agencies or news dealers.
Remittance must be by check, money order or draft. (Stamps not accepted.)

COUPON 13-39
Radio Digest, 123 W. Madison, Chicago
CHECK OFFER DESIRED
1. One year's subscription and choice of one volume. Send Vol. Check or M. O. enclosed \$5.00
2. One year's subscription and choice of two volumes. Send Vols. Check or M. O. enclosed \$7.00
3. One year's subscription and additional Volumes Nos.
Be sure to write plainly your name and address, giving city and state.

INSTRUMENTS OF EXCELLENCE
Langbein & Kaufman Variocouplers and Variometers
Malone-Lemmon Condensers and Control-o-Meters
Ballantine Tuned Radio Frequency Transformers and Units
Curcoids the supreme inductance by means of Precision Coupling Coils
Also in Stock
Amperites Meyers Hi-Mu Tubes
Literature sent on request
Radio & Mechanical Trading Corporation
Rametra CORPORATION 23 Warren St. New York City

R. F. and A. F. with Special Transformer

Crystal Rectifier Used in Circuit with Tube

It is with much hesitation that I give the theory upon which the following circuit operates. However, it comes closer

WORKSHOP KINKS? EARN A DOLLAR—

THERE are many little kinks worked out at home that would aid your fellow Radio worker if only he knew about them. There are new hook-ups, new ways of making parts and various unique ways of operating sets that are discovered every day. Radio Digest is very much interested in obtaining such material. Send them in with full details, including stamped envelope, so rejected copy may be returned. The work must be entirely original, not copied.

RADIO KINKS DEPARTMENT,
Radio Digest,
123 W. Madison St., Chicago

to giving the maximum output of a tube in signal strength than any other circuit

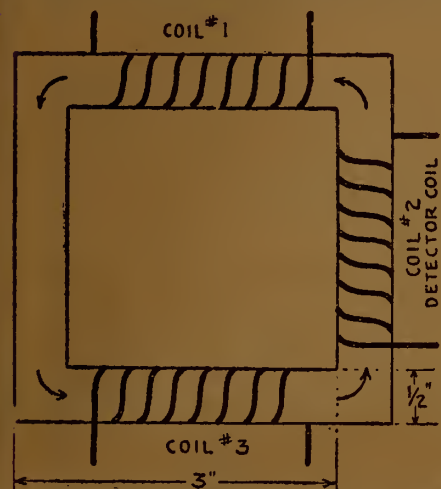

I have ever been able to operate. It gives the equivalent of two steps of R. F. and

YOU DON'T NEED TUBES

to receive concerts from Distant Stations. You can hear them on

YOUR CRYSTAL SET
if you fix it up the right way. You may already have everything you need and just have it connected up wrong. People using my methods hear programs clearly from stations

400 TO 1000 MILES AWAY
NO TUBES, BATTERIES or AMPLIFYING apparatus required. NO SPECIAL CRYSTAL NECESSARY. Changes often cost less than a dollar. Picture of my set and further information free. Write me today.

LEON LAMBERT

501 So. Volusia St. Wichita, Kansas

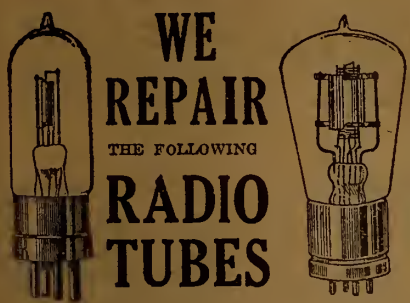

WE REPAIR THE FOLLOWING RADIO TUBES

WD-11}	OUR SPECIALTIES	{5 WATT TRANSMITTERS	
UV-199\$3.50	C-299\$3.50
UV-2002.75	C-3002.75
UV-2013.00	C-3013.00
UV-201A3.50	C-301A3.50
WD-113.50	WD-123.50
DV-63.00	DV-6A3.50
UV-2024.00	C-2993.50
UV-2993.50	C-3024.00

H. & H. RADIO COMPANY
P. O. Box 22-A
Clinton Hill Station NEWARK, N. J.

TRIPLE COILS GIVE STRENGTH

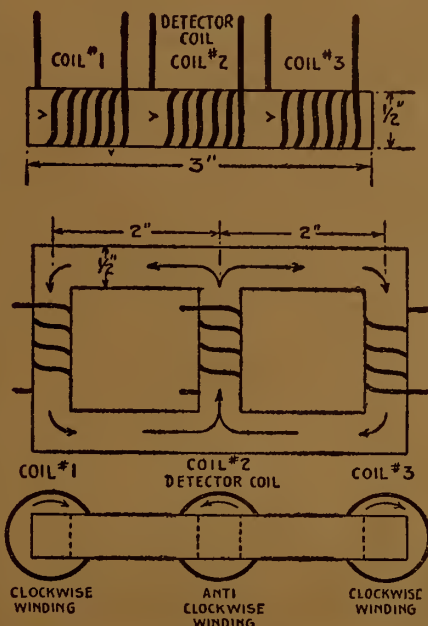
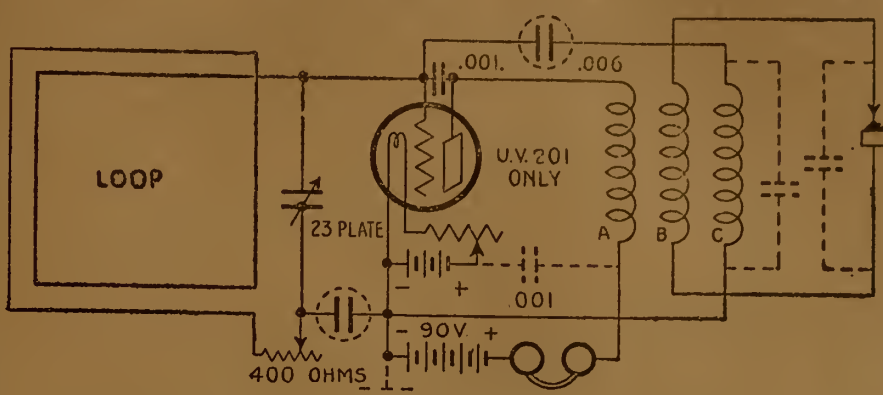

two steps of A. F. on the one tube and crystal rectifier. The .001-mfd. condenser acts as one stage of R. F., and one stage of A. F., and the triple wound transformer also acts as both an A. F. and R. F. amplifier.

Tracing out the impulse, it may be seen that the loop brings in the signal, which operates the grid. The plate current then passes through the primary of the transformer, and the secondary impulse feeds back to the grid. Also the impulse is fed back through the .001 condenser. The second secondary coil in the crystal circuit rectifies and a second feedback of A. F. occurs, which is also amplified one step of A. F. on the R. F. secondary and an additional step across the .001 condenser. The wave length is controlled by the 23-plate condenser, while signal

Special Condenser for a Flewelling Hook-Up

In the hook-up shown I use a variocoupler for tuning. Using an aerial and

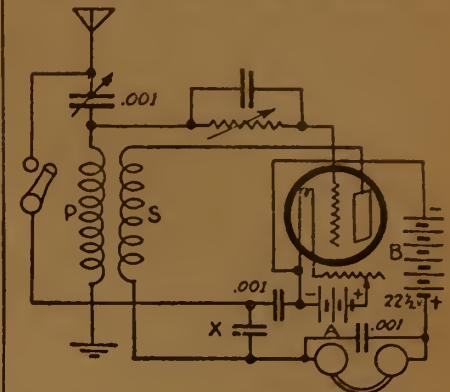

ground, the switch must be open, but it is possible with the switch closed to hear local stations with no QRM from VBG, which I could not shut out before. It must be closed when using the aerial or ground alone.

Local stations can be heard without either ground or aerial. The condenser marked X is a special one, tested for my purpose. It consists of 16 sheets of foil, 2 1/2 by 4 1/2 inches. The diagram explains the circuit.—A. Bickerton, Toronto, Can.

strength or oscillation is controlled by the 400-ohm rheostat.—J. O. Yelser, Omaha, Neb.

The Greatest Book on RADIO ever written

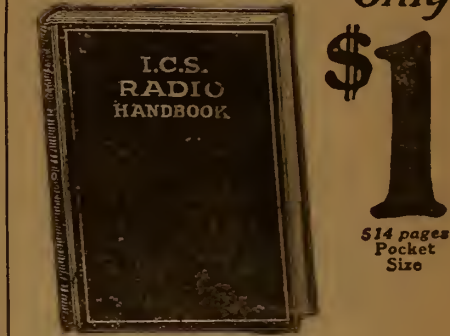

Compiled by HARRY F. DART, B.S.E.E.
Formerly with the Western Electric Co.,
and U. S. Army Instructor of Radio
Technically edited by F. H. DOANE

JUST off the press! The greatest book on radio ever written. Price only \$1. Filled with sound, practical, tested information for every radio fan, from beginner to hard-boiled owl. Written, compiled and edited by radio experts of national reputation.

Every page tells you something useful. And there are 514 pages! More than 150 illustrations and diagrams!

You may dip into this I. C. S. Radio Handbook at random, or hunt up special information you want, or read it right through. Different types of receiving and sending hook-ups are explained; proposed insurance regulations; lists of broadcasting stations; radio compass stations; interesting experiments; definitions; codes and symbols; technical data and thousands of suggestions for getting more pleasure out of radio. Will save you from wasting money on things that won't work.

Send \$1 to-day and get this 514-page I. C. S. Radio Handbook before you spend another cent on parts. Money back if not satisfied.

TEAR OUT HERE

INTERNATIONAL CORRESPONDENCE SCHOOLS
Box 8279-D, Scranton, Penna.

I enclose One Dollar. Please send me—post-paid—the 514-page I. C. S. Radio Handbook. It is understood that if I am not entirely satisfied I may return this book within five days and you will refund my money.

Name
Address

Positive Results ARE ASSURED WITH Eastern Coil Sets for the COCKADAY CIRCUIT

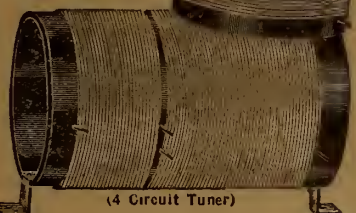

Now a standard, and in universal use, due to their efficiency in this wonder circuit. Made as per specifications of Mr. Cockaday, using No. 18 wire with D coil bank-wound

Complete Assembled Set of B, C and D Coils..... \$2.75

Hook-up directions and material list furnished free with each set of coils.
Mail Orders Filled. Dealers Communicate
EASTERN RADIO MFG. CO.
22 Warren Street, Dept. R. D., NEW YORK, N. Y.

S. HAMMER RADIO CO. BROOKLYN, N. Y.

Standard Merchandise Only

List Price	PHONES	Our Price
\$5.00	Narco 3000 Ohms	\$2.25
12.00	Western Electric	8.95
6.00	Brandes	4.75
12.00	Baldwin	7.95
7.00	Federal	4.95
7.00	Ambassador	3.75
TRANSFORMERS		
\$7.00	Federal No. 65	\$5.25
5.00	Acme	3.75
5.00	All American	3.65
7.00	Amertran	4.85
5.50	Thoradson	4.50
5.00	Marle	4.00
5.00	Pearlco	3.85
5.00	Erla	3.95
TUBES		
\$5.00	U. V. 200	\$3.95
6.50	U. V. 201A-199-W, D, 11-12	5.35
7.00	De Forest	5.25
VARIOMETERS		
\$3.50	Fisher	\$2.65
3.50	Workrite	2.95
7.00	Gillilan, Small	4.95
3.25	Shamrock	2.35
6.25	Pearlco	5.25
VARIOCOUPERS		
3.50	Fisher, 180° or Straight	\$1.95
3.50	Workrite, 180°	2.95
8.00	Gillilan	6.00
4.00	Stimpex, 180°, Silk Wound	2.80
3.25	Shamrock	2.35
6.50	Pearlco, Moulded	5.25
7.00	All Wave	5.50
\$65.00	Genuine Fada Parts for 5 Tube Neutrodyne Set	\$49.00

ALL MAIL ORDERS SHIPPED PROMPTLY
Orders over \$5.00 prepaid. Money orders or C.O.D. If it is not listed here, ask us; we have it at reduced prices.
All Goods Guaranteed. Your Money Refunded If Not Satisfied.



- ### MARVEL RADIO SPECIALS!
- DX-6 Volt Tubes, Guaranteed.....\$ 4.25
 - 1 1/2 Volt Tubes..... 4.50
 - Advance B Batteries—Highest Quality Guaranteed \$ 1.75
 - 22 1/2 V. small..... .75
 - 3.00 22 1/2 V. large..... 1.45
 - 4.75 45 V. medium..... 2.00
 - 5.50 45 V. large..... 2.90
 - Sterling Voltmeter, 1-50 volts..... 2.25
 - 3.00 Electro Hot Soldering Iron, small tip..... 2.50
 - 18.00 Westinghouse Rectigon Charger..... 14.63
 - 18.50 Homcharger, Gold Seal, A.C. current..... 14.95
 - 30.00 MUSIC MASTER LOUD SPEAKER..... 24.50
 - 7.00 SUPERTONE Loud Speaker, without unit..... 5.85
 - NEUTRODYNE PARTS for 5 Tube Set... 50.15
 - 6.50 Pioneer all mid. Bakelite Variometers 4.85
 - Nelson Moulded Bakelite panel mounting variometers..... 4.50
 - 7.00 Pioneer Mid. Bakelite Variocouplers 4.95
 - 2.50 180 deg. 1200 meters Variocouplers..... 1.92
 - 5.00 ACME Audio and Radio Frequency Transformers 3.95
 - 6.00 Brandes Superior Phones, genuine... 5.25
 - Narco Phones, genuine..... 2.50
 - 7 Strand Copper Wire, 100 ft. coils... .60
 - Freshman Variable Grid Leak..... .65
 - With Condenser..... .80
- Remittances Must Include Postage. Send for free Monthly Price List.
DEPARTMENT R. D.



Burned Out or Broken RADIO TUBES REPAIRED

All Tubes Guaranteed to Work Like New
Mail Orders Given Prompt Attention

24 HOUR SERVICE—All Tubes returned P.P. C.O.D.

RADIOTRONS	CUNNINGHAMS
WD-11 or 12.....\$3.50	C-11 or 12.....\$3.50
UV-200 2.75	C-300 2.75
UV-201 3.00	C-301 3.00
UV-202 3.50	C-302 3.50
UV-201A 3.50	C-301A 3.50
UV-199 3.50	C-299 3.50
DV-1 or 2..... 3.50	DV-6 or 6A..... 3.00

RADIO TUBE CORP.

70 Halsey St. Newark, N. J.
SEND TO NEAREST REPAIR BRANCHES
"RADIO TUBES"
39 West Adams St. CHICAGO, ILL.
RADIO TUBE SPECIALISTS
137 Market St. PHILA., Pa.
GLOBE ELECTRIC CO.
609 Chamber of Commerce Bldg., Pittsburgh, Pa.

Questions and Answers

(Many readers, through negligence or on purpose, send in questions and fail to sign the letter. We do not use such a letter in the Questions and Answers department of RADIO DIGEST, therefore it is useless to even send a letter without your name and address.—Editor.)

Audio Frequency
(05687) GMW, Woodbury, N. J.
I am a constant reader of your wonderful magazine, Radio Digest, and am tak-

ing the liberty to write for information on diagram of a combination crystal and tube, published in the September 1 issue. Hook-up I think is a very good one. I am herewith sending you same to have it checked if possible, and also would like to be advised how to connect to my other point for the addition of one step of audio frequency, as parts are not connected as shown.

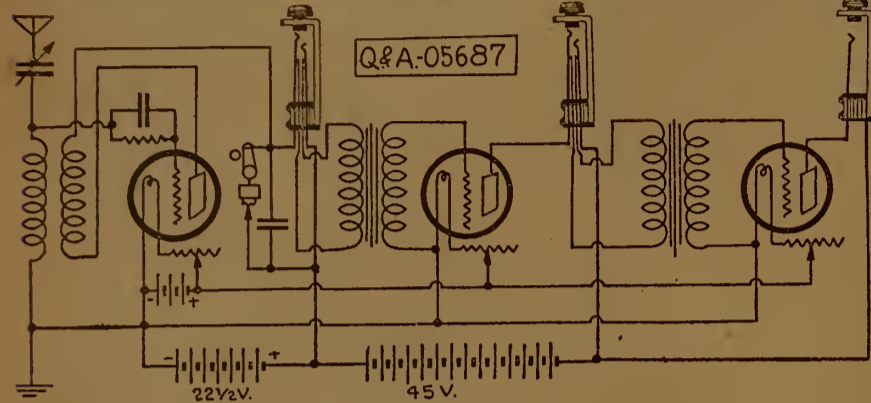

If this information will be given I will keep my eyes open for details of it in some one of your near future issues.

A.—In answer to your inquiry we present herewith a diagram showing the method of adding amplification. When amplifier tube is used, if desired, the crystal detector may be substituted for tube detector.

may serve until your enthusiasm drives you to extreme measures for the acquirement of greater efficiency in that part of your equipment. As to construction of an aerial, a single wire 150 feet in length, including lead-in, and placed as high as possible is advised.

Q. & A. 5212 Circuit
(05936) A.J. Libertyville, Ill.
I constructed the two variometer hook-up given in your Q. & A. columns in answer to question No. 5212, and have had good results from same. In about three weeks' time I have heard 43 stations.

I am using two Dayton variometers, two C-299 tubes, .002 mica condenser across primary of 10 to 1 All-American transformer, and .00025 grid condenser with 2-megohm grid leak.

The set is very sensitive, and sometimes I can tune a distant station out by removing my hand from the dials. Also, on low wave lengths, the setting of the plate variometer is very critical and I am troubled by body capacity when I set it.

Mere Woman and Radio!

(05561) BMCI, Dover, N. H.
I have been reading all the beginners' articles on Radio for the last three days (having got the "bug" suddenly), but as yet I have not found out what sort of a set to start out on. I do not wish the cost of parts to exceed \$30 (not including headsets) and naturally I want to get stations as far away as possible. What is this Miloplex hook-up and would it be advisable for a rank amateur to attempt it? I'm "nothing but a woman," but have worked a little with electricity and thought perhaps I might be able to get a Radio set together.

What hook-up would you advise me to try, and where can I get directions simple enough so that one who knows nothing about Radio could put it together? I should also want to know all about placing of the aerial, etc.

It was only three nights ago that I listened in for the first time, and now I have "Radio fever."

A.—We are happy to welcome a "mere woman" to our fraternity of enthusiasts in the Radio art.

Not because you are a woman, but because being one, we know that you are possessed of good sense we are advising that the better part of wisdom in entering this fascinating pastime is to proceed in a progressive spirit.

We recommend the simple circuit illustrated in a simple manner on page 18 of the October 13 issue of Radio Digest. As

I think it is on account of using either the wrong value of grid leak or phone condenser, and would request that you kindly furnish me with the proper values of the parts necessary; also any other information to increase the efficiency.

I am using an 80-foot aerial, single strand, 20 feet high, with a 10-foot lead-in, and a 25-foot ground lead.

A.—We take pleasure in congratulating you upon your very excellent reception record.

Body capacity effect is not normally a marked attribute of the circuit under discussion, and it may be eliminated by shielding the back of the panel with tinfoil and grounding the shield.

The correct value of the grid leak is 2 megohms and of the phone condenser, .001 mfd.

Crystal Hook-up

(06000) LAB, Los Angeles, Calif.

In the September 15, 1923, issue of the Radio Digest is a crystal set hook-up capable of receiving 300 miles. This hook-up does not show any variable condensers for tuning; is this correct? Would variable condenser in the aerial or ground lead help, and what capacity should I use? Would a 180 degree Shamrock coupler and Shamrock variometer be all right to use?

How often should the coupler be tapped? A.—In the long range crystal detector circuit mentioned no variable condenser is

indicated because it offers no advantage.

A standard variocoupler will serve; that of your specification will be effective. A primary wound with 56 turns and tapped at every seventh turn is suitable.

R. D.-102

(05902) A. J. S., Chicago.

Have you complete data as to what kind of a variocoupler is used in hook-up R. D.-102? I wish to know size of coupler and number of turns of wire, etc.

A.—Any standard type of variocoupler can be used in circuit of R. D.-102. If you intend to construct an efficient coupler, 56 turns of number 20 wire, tapped at every seventh turn, for primary, and 50 turns of number 26 wire for secondary, serve well. Either d.c. or s.c.c. can be used.

B-T \$5.00
Bremer Tully Vernier Tuner
Distance Clearness Selectivity
These are only three features of the Bremer Tully Vernier tuner. In Chicago with four high power stations, outside stations can be brought in clear and loud eliminating local interference.
Better Tuning
Third edition now ready (free with each Tuner). Tells you why and shows you how. Ask your dealer today to see the B-T Vernier Tuner.
BREMER TULLY MFG. CO.
532 South Canal Street CHICAGO

ROOT for RADIO!!
Write for Our Bulletin

PHONES	PANELS (High Grade)
Baldwin-C\$8.25	7x10\$.75
Brandes5.25	7x181.35
Nerco2.75	7x241.75

RADION DIALS, 3", 30c; 4".....\$.40

TRANSFORMERS	One Tube DX Set
All American\$4.00	SPECIAL FOR XMAS
Eria Reflex4.25	ORDER
Acme, Audio3.95	NOW\$15.00

BRANDES LOUD SPEAKER.....\$9.50
We carry a complete line of standard parts and sets.
INCLUDE POSTAGE WITH ORDER
ROOT RADIO CO., Inc.
Dept. D. 2525 Broadway, New York

STA-RITE BATTERY CO., Louisville, Ky.

This large saving is made possible by coming direct to you, instead of going thru Jobbers, Distributors, Branch Houses, Dealers, Salesmen etc. Sta-Rite Batteries are guaranteed for 2 yrs. in writing and are made by one of the Largest battery factories in the Country, and who have been building batteries for over 8 years.

TRY TO BEAT THESE PRICES

AUTOMOBILE BATTERIES

6 Volt, 11 Plate, Ford, Chev, Dup, Buick Cleveland, Duant \$11.50
8 Volt, 13 Plate, Overland, Nash, Buick, Rec, Page Hudson, Studebaker, Essex, Willys etc. \$13.25
12 Volt, 7 Plate, Maxwell, Dodge, Franklin, \$16.00
OTHER SIZES ON REQUEST

RADIO BATTERIES

2 volt for W.D.1 & W.D.12 6 volt 60 amp. hr. \$7.98
tubes run 30J hours on 1 6 " 80 " " 8.85
charge.....\$4.00 6 " 100 " " 10.60
4 volt for U. V. 199 \$7.55 6 " 120 " " 12.10
6 " 150 " " 14.50

All batteries are fully guaranteed in writing and shipped subject to examination; Send 10 per cent. with order, balance on arrival. Deduct 5 per cent. if full cash accompanies order. Shipped same day order received. Act now.

KASPER'S RADIO RECORD BOOK

Don't Waste Your Time

Looking for stations you already had. When you get a station simply copy the readings in a KASPER RADIO RECORD BOOK, then when you want it—IT'S THERE. This book can be used with any set and it is so arranged and printed that each day's broadcastings are kept separate; also contains full illustrations and instructions HOW TO RECORD STATIONS. 25 cents—or 6 for \$1.00, postage paid—don't send stamps.

Write Today
KASPER BROTHERS COMPANY
317 Lorain St. Bank Building
Cleveland, Ohio
Dealer or Agents Wanted Everywhere

Workman Radio Service
"THE ACCENT IS ON SERVICE"

14-16 Vesey St. NEW YORK

VARIOCOUPERS

\$3.50 Workrite 180° Silk Wound.....\$2.95
3.00 Mills 180° Silk Wound.....1.95
3.50 Fisher, Large, 90°.....2.25
2.75 Fisher, 180°.....1.75

VARIOMETERS

\$3.50 Workrite.....\$2.95
5.00 Pathe Moulded.....2.25
3.50 Fisher, Large.....2.65

CONDENSERS

\$2.00 R. C. 11 plate.....\$1.05
2.35 R. C. 23 plate.....1.35
2.75 R. C. 43 plate.....1.65

VERNIER CONDENSERS

\$4.00 R. C. 23 pl.....\$2.25
5.00 R. C. 43 pl.....2.95

PHONES

\$18.00 DR. SEIBT IMPORTED "SUPER HEADSET".....\$5.90
\$6.00 Brandes Superior.....\$4.90
12.00 N. & K., Imported.....5.50
5.00 Nerco.....2.50
Ambassador.....3.89
6.00 Potter Precision Headset.....4.25
5.00 Diamond De Luxe Phones.....3.50
Mail orders promptly attended to. All orders amounting to \$5.00 or more will be shipped prepaid. Will ship C. O. D. unless remittance accompanies order.
The above items are just a few of our numerous attractive priced articles, which are contained in our BULLETIN OF RADIO PARTS. Gladly sent to you upon request.

MU-RAD DEALERS
are making money!

And they don't find it hard to do it either. Why? Because the Mu-Rad Receiver itself does practically all the selling. A careful check on the sales of one Chicago dealer, proved that Mu-Rads are sold in 8 out of 10 competitive demonstrations!

Write for Mu-Rad territory
Choice territory is still open to responsible, rated dealers. Kindly use your business stationery when writing for complete details.

Complete stock of parts
WESTERN ELECTRIC COMPANY
GENERAL RADIO COMPANY
Write for Details and Discounts

Chicago Radio Apparatus Co.
Jobbers of Good Radio Merchandise
General Offices: 407 South Dearborn Street
CHICAGO

DUPONT PYRALIN SHELSTONE

Loud Speaker
With
Nath. Baldwin Head Set
Type C
Perfect Results

Shelstone is made of Dupont's Pyralin, is transparent and one of the most attractive Loud Speakers on the market.
It is built differently to take advantage of the most correct acoustic principles and reproduces music and speech with a clear tone.

Loud Speaker with phones .. \$15.00
Loud Speaker postpaid 3.00

Satisfaction guaranteed, C. O. D. or cash with order. Dealers write for discounts.
THE SHELSTONE COMPANY
185 Clinton Avenue NEWARK, N. J.

WE REPAIR YOUR VACUUM TUBES

WD-11-12, UV-199, UV-201-A
C-301-A\$3.50 each
UV-200, C-300..... 2.75 each
UV-201, C-301..... 3.00 each
DV-6, DV-6-A..... 3.50 each

All Work Fully Guaranteed
Quick Service—Repaired Tubes shipped C. O. D. unless accompanied by remittance plus postage.

NEW TUBES
A-399 (Type UV-199) \$4.10
A-401-A (Type UV-201-A) EACH
A-12 (Type DW-12)

All the above Tubes guaranteed amplifiers and detectors. Shipped C. O. D., postage prepaid.

To the Man Who Builds His Own: Write for Our Bulletin of Parts at Bargain Prices. Standard Merchandise Only.

ABALENE RADIO 416 Broadway
NEW YORK CITY

DEALERS
PROMPT SHIPMENTS
LIBERAL DISCOUNTS

COTO SPECIAL
Audio Frequency Transformer
\$2.50

COTO-COIL Distributors
Note!!
We are the largest exclusive Radio Jobbers in the Middle West

HUDSON-ROSS
123 W. Madison St. Chicago

Radiophone Broadcasting Stations

Corrected Every Week—Part IV

State, City, Call	State, City, Call	State, City, Call	State, City, Call	State, City, Call	State, City, Call	
Alabama: Auburn, WMAV Birmingham, WSY Mobile, WEAP Montgomery, WKAN	Illinois: Belvidere, WOAG, WTAH Cambridge, WTAP Carthage, WCAZ, WTAD Chicago, KYW, WAAF, WDAP, WIAZ, WMAQ, WSAH, WSAX Decatur, WBAO, WHAP Elgin, WTAS Galesburg, WRAM Joliet, WWAE Lake Forest, WABA Mattoon, WQAL, WTAN Mt. Vernon, WABF Oak Park, WTAY Peoria, WJAN, WQAX Rockford, KFLV, WIAB Streator, WTAX Tuscola, WDJ Urbana, WRM Zion, WCBD	Maine: Bangor, WABI Houlton, WLAN Portland, WTAJ	New Hampshire: Chesham, WSAU Laconia, WICAV	Pendleton, KFFE Portland, KDYQ, KPEC, KFIF, KGG, KGN, KGW Salem, KFCD	Washington: Aberdeen, KNT Bellingham, KDZB Everett, KFBL Lacey, KGY Neah Bay, KFJH Pullman, KFAE Seattle, KZZE, KDZT, KFTR, KFIY, KFJC, KHQ, KJH, KTW Spokane, KFIO Tacoma, BEI, KFBB, KGB, KMO Walla Walla, KFCE Wenatchee, KDZI, KZV Yakima, KFJQ	
Arizona: Phoenix, KDYW, KFAD, KFCE Tucson, KFDE	Indiana: Auderson, WABC Brookville, WSAL Greencastle, WLAX Greentown, WJAK La Porte, WJAF Marion, WIAQ Mishawaka, WQAO Muncie, WJAF South Bend, WABJ, WGZ West Lafayette, WDAA	Maryland: Baltimore, WCAO, WEAR Frostburg, WPAQ	New Jersey: Atlantic City, WHAR Camden, WABU, WWAF Gloucester City, WRAX Lambertville, WTAZ Newark, WLAAM, WABS, WBS, WOR, WRAZ N. Plainfield, WEAM Paterson, WBAN Trenton, WMAL, WOAX, WWAB	Pennsylvania: Allentown, WCBA, WSN Altoona, WGAW Butler, WBR Easton, WMAP East Pittsburgh, KDKA Erie, WQAV Grove City, WSAJ Harrisburg, WAHB, WBAK Haverford, WBAQ Johnstown, WTAC Lancaster, WDBC, WQAL McKeesport, WIK Parkersburg, WQAA Philadelphia, WQAU, WDAK, WFL, WGL, WTAD, WIP, WNAT, WOO, WWAD Pittsburgh, KQV, WCAE, WJAS Reading, WBBD, WRW Scranton, WQAN, WRAY State College, WPAB Villanova, WQAM Washington, WABT Wilkes-Barre, WBAX	West Virginia: Charleston, WPAZ Clarksburg, WHAK	
Arkansas: Conway, KFKQ Fayetteville, KFDV, KFMQ Fort Smith, WCAC Little Rock, KFLQ, WCAV	Iowa: Ames, WOI Atlantic, KFLZ Boone, KFGQ Burlington, WIAS Cedar Falls, KFJX Cedar Rapids, KFLL, WJAM, WKAA Centerville, WDX Davenport, WHAI, WOC Dexter, KFV Fort Dodge, KFER, KFJY Gladbrook, KFIC Iowa City, WHAA Lamoni, KFFV Le Mars, KFQY, WIAU Marshalltown, KFJB Newton, WIAH Ottumwa, KFLL Sigourney, WOAD Sioux City, KFMR, WEAU Waterloo, WHAC, WRAN	Michigan: Berrien Springs, KFGZ Dearborn, WVI Detroit, KOP, WCX, WWJ East Lansing, WKAR Flint, WEA Houghton, WVAO Kalamazoo, WQAP, WLAQ Menominee, KFLB Rogers, WHI Saginaw, WABM	New Mexico: Albuquerque, KFLR State College, KOB	Rhode Island: Cranston, WKAP East Providence, WKAD Providence, WEAN, WJAR, WRAH, WSAD, WTAG	Wisconsin: Beloit, WKAW Fond du Lac, KFIZ Kenosha, WQAK La Crosse, WAIN Madison, WQAY, WHA Milwaukee, WAAK, WCAV, WHAD, WIAO Neenah, WIAJ Oshkosh, WTAQ Sisilth, WJAC St. Croix Falls, WRAL Waupaca, WPAH	
California: Bakersfield, KDZB Berkeley, KQI, KRE Del Monte, KLN El Monte, KUY Fresno, KMJ Hollywood, KFAR Long Beach, KSS Los Angeles, KDZF, KFCL, KFI, KHJ, KJS, KNV, KNX, KUS Los Gatos, KFHQ Modesto, KXD Oakland, KLS, KIX, KZM Richmond, KFCM Sacramento, KFBK San Diego, KDPT, KDYM, KFBC San Francisco, KFDS, KPO, KSL, KUO San Jose, KQW San Luis Obispo, KFBE Santa Ana, KFAW Santa Barbara, KFJH Stanford Univ., KRGH Stockton, KJQ, KWG Venice, KFAV	Kansas: Anthony, WBL Beloit, WPAK Hutchinson, KFHX Iola, KFID Louisburg, KFIL Manhattan, WTC Marion, WRAD Milford, KFKE Parsons, WQAJ Pittsburgh, KFIV Topeka, WJAO, WPAW Towanda, KFJW Wichita, WEAH	Minnesota: Hutchinson, WFAN Minneapolis, KFZ, KFEX, WBH, WCAS, WCE, WLAG, WLB Moorhead, WPAU Northfield, WCAL St. Cloud, WFAM St. Paul, AV7	New York: Albany, WNJ Buffalo, WGR Canandaigua, WSAW Canton, WCAJ Cazenovia, WMAJ Ithaca, WYAI Lockport, WMAK New York, WBAV, WDT, WEAJ, WHN, WJX, WJY, WJZ, WLAJ, WQAO, WSAP Port Chester, WSAJ Poughkeepsie, WFAJ Rochester, WABO, WHAM Schenectady, WGY, WRL Syracuse, WBAJ, WLAH, WNAJ Tarrytown, WRW Troy, WHAZ Utica, WSL	South Carolina: Charleston, WNAQ, WQAH Clemson College, WSAC Greenville, WQAV	Wyoming: Douglas, KFEV Laramie, KFBU	
Colorado: Boulder, KFAJ Colorado Springs, KFCK, KFKQ, KFKZ Denver, AA3, KDZQ, KFAP, KFEL, KFKH, KFLE, KLZ Greeley, KFJZ, KFKA Gunnison, KFHA Lafayette, KFKH Trinidad, KFBS	Delaware: Wilmington, WHAV, WOAT	Missouri: Butler, WNAR Cameron, WFAQ Cape Girardeau, WSAB Carrollton, KFJ Columbia, WAAJ Independence, KFJX, WPAJ Jefferson City, WOS Joplin, WHAH Kansas City, WDAF, WHB, WMAJ, WJAT Marshall, WJAT St. Joseph, KFHD St. Louis, KFEZ, KFIB, KFGJ, KSD, WCK, WEB, WEW, WMAJ, WRAO Springfield, WIAI Tarkio, WIAT Webster Groves, WOAL	North Carolina: Asheville, WPAJ Charlotte, WBT	South Dakota: Brookings, KFDY Rapid City, WCAT Sioux Falls, WFAT Vermillion, WEAJ Yankton, WNAJ	Tennessee: Knoxville, WABV, WNAV Lawrenceburg, WOAN Memphis, WMC	Alaska: Juneau, KFTU
Connecticut: Hartford, WDAK New Haven, WPAJ Storrs, WABL Waterbury, WQAD	District of Columbia: Washington, WABE, WCAP, WDM, WJL, WJH, WMU, WQAW, WRC	Montana: Billings, KFCH Bozeman, KFDO Butte, KFAP, KFKV, KFJA Great Falls, KDYS Havre, KFBB Missoula, KFLW Stevensville, KFJB	North Dakota: Fargo, KFJY, WDAY, WPAK Grand Forks, KFJM Mayville, KFHU	Texas: Ablene, WQAO Amarillo, WDAQ, WQAC Austin, WCML, WNAS College Station, WTAJ Dallas, KFEZ, WDAO, WFAA, WRR El Paso, WDAH, WPAT Fort Worth, KFJZ, WBAJ Galveston, KFJL, WHAB, WJAC Houston, KFCV, WCAK, WEAY, WEV, WBAJ Orange, KFGX Plainview, WSAJ Port Arthur, WFAH San Antonio, ASS, WCAR, WQAI San Benito, KFLU Tyler, WQAF Waco, WJAD, WLAJ, WWAC Wichita Falls, WKAF	Alaska: Honolulu, KDYX, KGU Lihue, KFHS	
Florida: Jacksonville, WABG, WDAL Miami, WQAM Pensacola, WGAN, WLAJ St. Petersburg, WSAG Tampa, WDAE	Georgia: Atlanta, WSE Gainesville, WKAY Macon, WMAZ	Nebraska: Fremont, WQAE Grand Island, KFJA Hastings, KFKX Kearney, KFJU Lincoln, KFDD, WFAV, WJAB, WMAH Norfolk, WJAG Oak, KFEO Omaha, KFCZ, KRFK, WAAW, WIAK, WNAJ, WOAW Tecumseh, WTAU University Place, WCAJ Utica, KFGV York, KFDB	Ohio: Canton, AQ6 Cincinnati, WAAD, WHAG, WLV, WSAI Cleveland, KDPM, WHK, WJAX, WTAM Columbus, WBAV, WCAH, WQAO, WMAJ, WPAJ Dayton, AV5, WABD Dover, WABP Fairfield, WL2 Granville, WJD Hamilton, WRK Lima, WQAC Marietta, WBAW Newark, WJBB New Lebanon, WPG Pomeroy, WSAZ Sandusky, WABH, WQAF Springfield, WNAJ Toledo, WABR, WTAL Yellow Springs, WRAV	Utah: Ogden, KFCE Salt Lake City, KDYL, KFLH, KZN	British Isles: Aberdeen, 2BD Birmingham, 5IT Bournemouth, 6BM Cardiff, 5WA Glasgow, 5ZY London, 2LO Manchester, 2NY Newcastle, 5NO	
Idaho: Boise, KFAU, KFDD, KFFB Kellogg, KFEY Moscow, KFAJ	Kentucky: Lexington, WQAH Louisville, WHAS, WLAP	Oklahoma: Ardmore, WQAA Bristow, KFJK Chickasha, KFGD Oklahoma City, KFJF, WKY Norman, WNAJ Okmulgee, WPAJ Tulsa, WQAF, WLAL	Oregon: Astoria, KFJH Arlington, KFGL Baker, KFPA Corvallis, KFJH Hillsboro, KFPO Hood River, KFHB, KQP Medford, KFAY	Vermont: Bellows Falls, WLAK Springfield, WQAE	Canada: Bellefleur, CFCO Calgary, CFAC, CFCN, CHBC Edmonton, CFCK, CJCA Hamilton, CFCC Iroquois Falls, CFCH Kingston, CFRC London, CFOW, CJGC Montreal, CFCE, CFUC, CHYC CKAC Nanaimo, CFDC Ottawa, CJOJ Quebec, CFJC, CHCD Regina, CFCK St. John's, CFJC Saskatoon, CFCC Sudbury, CFRC Toronto, CFCA, CJCD, CJCN, CJSC, CKCE Vancouver, CFCC, CHCL, CJCE, CKCD Victoria, CFCL, CHCE Winnipeg, CKY	

PART IV—STATION DATA

(The following schedules complete the alphabetical station data list, Part III of which was given last week.)

WVAO, Houghton, Mich. 244 meters. 250 watts. Mich. College of Mines.

WWJ, Detroit, Mich. 517 meters. 500 watts. The Detroit News. Daily ex Sun, 9:30-9:45 am, household hints; 9:45-10:25, health talks; 10:25-10:30, weather; 11:55-12, time; 12:05-12:45 pm, music; 3:30-3:35, weather; 3:35-4:15, markets; 5-6, sports, April 22, and every other week, 8:30-10 pm, concert, Sat. night silent, Thurs, 10-12 pm, "midnight special"; Sun, 2 pm, 7:30, church services. Fill in weeks, 7-8:30 pm, concert; Sun, 11 am, 5:30, church services. Eastern.

WWL, New Orleans, La. 280 meters. 100 watts. Loyola Univ.

2BD, Aberdeen, Scot. 495 meters. British Broadcasting Co.

2LO, London, Eng. 363 meters. British Broadcasting Co.

2ZY, Manchester, Eng. 370 meters. British Broadcasting Co.

5IT, Birmingham, Eng. 425 meters. British Broadcasting Co.

5NO, Newcastle, Eng. 400 meters. British Broadcasting Co.

5SC, Glasgow, Scot. 415 meters. British Broadcasting Co.

5WA, Cardiff, Wales. 353 meters. British Broadcasting Co.

6BM, Bournemouth, Eng. 385 meters. British Broadcasting Co.

6KW, Tunnicliffe, Cuba. 332 meters. 500 watts. Frank H. Jones. Slogan, "If You Hear the Koo of the Cuckoo You Are In Tune With Tunnicliffe." Mon, Tues, Fri, Sun, 9 pm, music. Wed, Thurs, Sat, 6:30 pm, music. Central.

A Good Indoor Antenna

A new type of indoor antenna which rivals the loop can be made in a moment with nothing more than 100 feet of wire. The wire is coiled into a long spiral and suspended by one end. Number 16 or 18 insulated wire works well, although many other kinds are quite as good, heavier wire being, in general, better than light wire. Wind the coil on any convenient tube;

suspend it from a window and it will rival an outdoor aerial. It cannot be counted upon to give results with a crystal set, but is practical for any kind of vacuum tube receiver. It is almost always better than bedsprings, piano strings, and even better than wires strung about the room.

ERLA REFLEX SETS
BUILT AND REPAIRED
Panels Drilled
R. WEISENMAYER
421 West 65th Street CHICAGO

ROYAL MANUFACTURING COMPANY
Dept. 50 World Buildings, New York City

E. MacDonald of Bangor, Me., received Wenatchee, Wash., on 1 tube Royal Portable Broadcast Receiver. One dial control. Takes all wave lengths. Complete parts, cabinet, instructions, \$ 7.95
Royal Portable 1 tube set assembled, \$ 10.00
Pboses, batteries, tube, aerial, etc., extra, \$ 9.75
Autotex circuit complete Tube FREE, \$ 18.50
Cockaday-Bainart—Ultra-Audion circuits, panel, complete parts—Tube Free with each \$ 3.67
5 Tube ROYAL Neutrodyne (mounted), \$ 49.47
ROYALTRON tubes, guaranteed. Standard base, 1½ volt detector or amp. 6 V. amp. \$ 3.95
Write for Catalog

The New
WALNART
INDUCTANCE SWITCH

Only with positive contacts can you get good reception. Switch points are unsightly and the contacts are poor. A Walnut Inductance Switch, 1-10 points, gives positive contact and better reception. Bakelite numbered dial shows exact position at all times.

List Price **\$1.25** Complete with Dial

List Price **\$1.00** **WALNART** VARIABLE GRID RESISTANCE

Gets the best results from every tube. Cleans up hissing and brings in signals clear and strong. Nothing to wear out, lasts a life time. Both instruments Condensite Celoron bases—the perfect dielectric insulation. Send for catalog of the Walnut parts.

WALNART ELECTRIC MFG. CO.
Dept. 415, 1249 W. Van Buren St., Chicago, Ill.

WEIGHS ONLY 8 OZ.

The Scientific

SEND NO MONEY!

20,000 TURNS EQUIVALENT TO 3,000 OHMS

Order TODAY by Postcard and Pay Postman on arrival

2.95 POST-PAID **LOUD SPEAKER UNIT \$1.95**

We Guarantee The Scientific Headset to be the greatest value on the market. Try it for five days. If not satisfactory send it back and your money will be refunded immediately. Circular on request. Dealers wanted.

THE SCIENTIFIC ELECTRIC WORKS
98 Brookline Ave. DEPT. W. BOSTON, MASS.
Agents for New York and Vicinity—AMBASSADOR SALES CO., 74 Cortlandt St., Phone Cortlandt 6296

Radio

Illustrated

Baby Peggy Montgomery is the rival screen star of Jackie Coogan, and is shown here (with her mother) making her first speech over the Radiophone. She is not yet five years old
K. & H. Photo

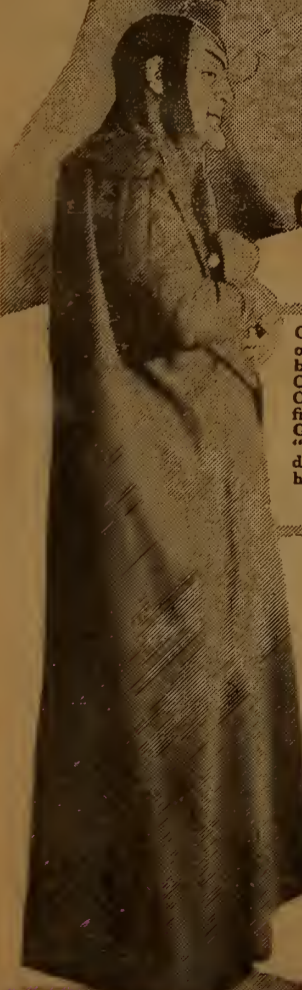

Georges Baklanoff—the famous baritone of the Chicago Civic Opera—as “Mefistopheles” in Gounod’s “Faust.” Radiophans have heard him in several parts

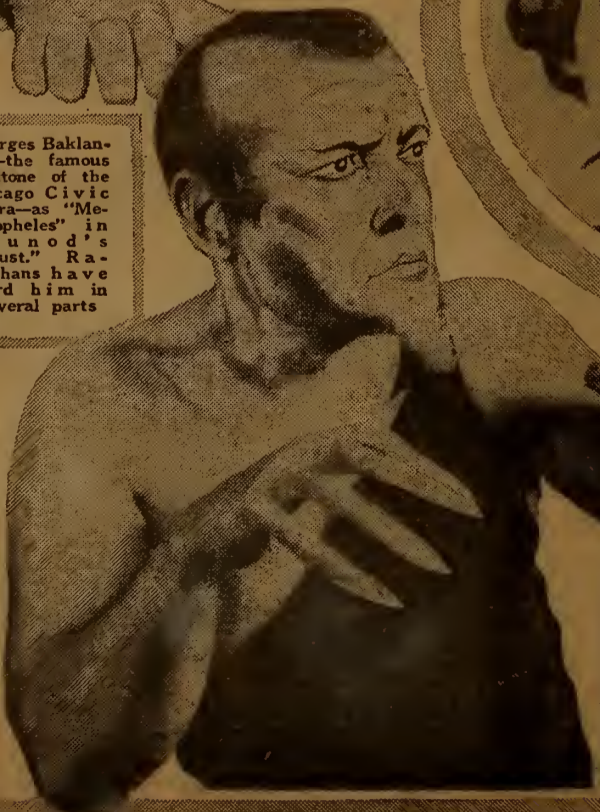

Here is another “devil of a man” — Virgilio Lazzari, in title part of Boito’s “Mefistofele.” He is a bass-baritone, and has sung many parts during the present season at Chicago, notably the “High Priest” in “Aida,” the revolutionary servant in “Andrea Chenier,” and “Sparafucile” in “Rigoletto,” all of them broadcast by KYW or WMAQ

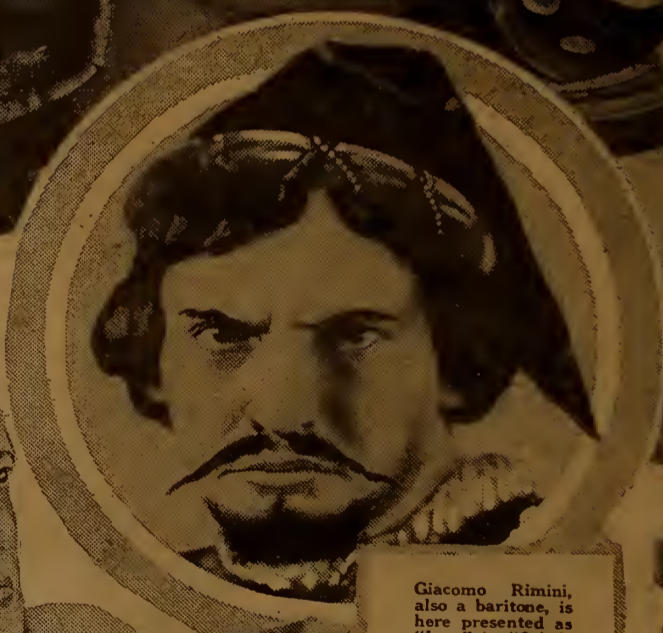

Giacomo Rimini, also a baritone, is here presented as “Iago” in “Othello,” broadcast recently by KYW, Chicago. Earlier he has been heard by listeners in as “Rigoletto” in Verdi’s opera of that name, and in “Andrea Chenier”

“Cheer” can be got out of a bottle even in these days, witness the outfit below, in which a Radiophan has rigged up a “bone-dry” bottle as a tuning coil for his crystal set. The coils are wound on the outside of the bottle. It was exhibited at a recent show
Int. Photo

