

Radio Topics

September, 1923



INTER
NATIONAL
NEWS
REEL



20 Cents

MANHATTAN

ELECTRICAL SUPPLY CO., INC.

MAKERS OF THE FAMOUS

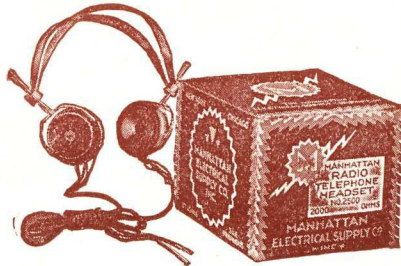

MANHATTAN
RADIO HEAD SET

OLDEST AND LARGEST
DISTRIBUTORS OF

Radio  Corporation
of America

GREBE RADIO

*We have the new Grebe
CR12 Broadcast Receiver
Get one and Satisfaction*

KENNEDY
EQUIPMENT

114 SO. WELLS ST., CHICAGO

NEW YORK

ST. LOUIS

SAN FRANCISCO



Buy at the Radio Store where they display this sign—the distinguishing mark of Blairco Proven Products.



ATLAS HEAD PHONES

The only high-grade receiver set offered at a reasonable price. Sensitiveness and adaptability positively is unequalled. Price \$9.00.

Atlas Loud Speaker

Height over all, 21 in. Horn, 11 in. in diameter, of seamless vegetable fibre, dense and non-vibrating. Sound reflecting base and unit casing of dark red polished Bakelite. Priced complete with horn attachment and cord, \$25.00.

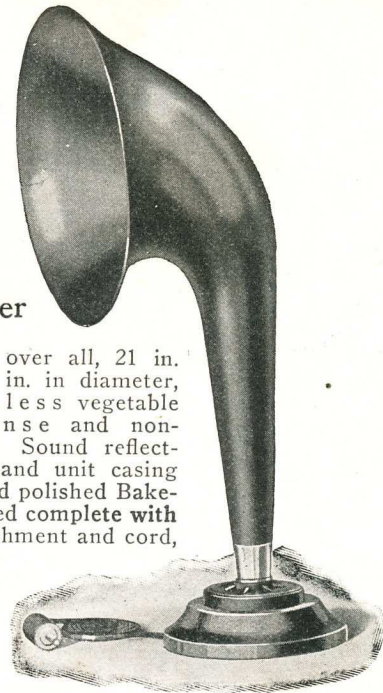

The ATLAS Gives Tone Volume With Perfect Tone Control

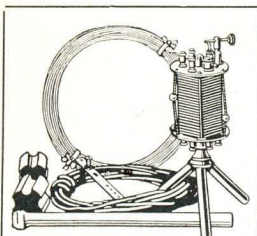

Blairco "4" Crystal Set

Takes 4 head phones—Enables 4 to listen as well as 1. All nicked steel 9 in. high. Price only \$7.50.

Complete with copper clad aerial, waterproof lead-in and ground wire, strain and wall tube insulators, lightning arrester ground wire clamp and set of \$9.00 Blairco Headphones, \$17.50.

Dealers: An unbeatable profit opportunity is offered you in the Blairco Proven Products. Write quick for our proposition.

Multipled enjoyment with your radio follows the use of a loud speaker which, set in any convenient spot, throws out the tones so that a roomful of family and friends can hear.

But in selecting the loud speaker, bear in mind that loudness without clearness is mere noise—and get an ATLAS.

With the Atlas you get the true tone of the original—clear, pure, exquisitely sweet—and perfectly controlled. Tone distortion, distracting mechanical sounds, confusing echoes and blasts—all are noticeably absent.

All is due to the patented double composition diaphragm—found only in the Atlas. And to the use of finer materials which, with scientific assembling, also insures permanence.

A typical example of the extra quality afforded at no extra cost by all radio equipment sold under the Blairco trademark.

No matter what you want in Radio, buy at the "Blairco" Radio store and get dependable value. Every article sold under the Blairco trade name, whether our own make or others, is of proved superiority. Exacting tests have proved it the best of its kind, bar none!

If you have no Blairco dealer, write us now for Folder and Prices

Mitchell Blair Co.

'First With the Best'

1429 So. Michigan Ave., Chicago

"Dimensions are limitless; time is endless." Chuang Tzu—

The Wise man conquers the barriers of time and space with

the New **GREBE**
Broadcast Receiver
Doctor My.



Receive all broadcasting without outdoor antenna, loop, or storage battery!

This Receiver employs Regeneration and Tuned Radio Frequency Amplification with only two simple tuning adjustments.

Write for
"Seven Points of Satisfaction"



GREBE RADIO

A. H. GREBE & COMPANY, Inc.
Richmond Hill, N.Y.
Western Branch, 451 East 3rd St., Los Angeles, Cal.

Licensed under Armstrong
U. S. Pat. No. 1,113,149

Type CR-12

Radio Topics

An Illustrated Monthly Devoted to Radio

Volume III

September, 1923

Number 8



RADIO ON FAST PASSENGER TRAIN IS POSSIBLE

A test recently conducted by the Southern Pacific Railroad and San Francisco Examiner proved that it is possible for passengers on a rapidly moving train to receive radio concerts as satisfactorily as in their own homes. The Wilson McGuire Co., Inc., installed the receiver, and John McGuire operated it between San Francisco and Chicago. Perfect concerts were received from stations 1,600 miles distant. Miss Elinor Whittemore, famous violinist, played an obbligate to a piano solo, received over the radio from a distant sending station. (Photo by International Newsreel.)

CONTENTS

	Page
Drifting to Music.....	Cover
Plans Completed for Big Radio Show.....	7
Washington's Giant Broadcasting Station.....	8
Broadcasters' Association Not Worried.....	9
Adjustable Fixed Condenser, by Charles F. Filstead.....	13
Can You Write a Radio Play?.....	14
World-Wide Communication, by Frank R. Carney.....	15
Broadcasting by Wired Radio, by Bert T. Bonaventure.....	17
That Single Dry Cell Set, by C. E. Butler.....	19
Correspondence With Radio Readers.....	21
Radio vs. Motion Pictures.....	23
Practical Hints on Designing Regenerative Receiver, by Paul A. Perry	25
War on Static.....	27

PUBLISHED MONTHLY BY RADIO TOPICS

Entered as second-class matter at the Postoffice at Oak Park, Ill., February 25, 1922,
under the Act of Congress of March 3, 1879.

Business and Editorial Office at 1112 North Blvd., Oak Park, Ill.

Chicago Phone: Austin 9300.

New York Office, 240 Broadway

Copyright 1923, by Radio Topics

RADIO TOPICS

The National Radio Monthly



FOUNDED 1921

PUBLISHED EVERY MONTH BY
RADIO TOPICS, PUBLISHERS

1112 North Blvd.

OAK PARK, ILLINOIS, U. S. A.

J. RAY MURRAY, EDITOR
NANKO C. BOS, Managing Editor
WILL M. HIGHT, Business Manager

PUBLISHING AND EDITORIAL OFFICES

Chicago Phone: Austin 9300 Oak Park Phone: Oak Park 3200

Twenty Cents the Copy From All Newsdealers. By Subscription: To the United States and Possessions, Cuba and Mexico, \$2.00 the Year. Remit by U. S. Money Order, Express Money Order, Check or by Draft, payable in U. S. Funds.

To Canada—By Subscription, \$3.00 the Year. Single Copies 25 Cents—Canadian or U. S. Funds.

RADIO TOPICS is on sale the 10th of preceding month. Text and advertising forms close the 22nd of second month preceding issue.

Vol. III

September, 1923

No. 8

Radio's Friend Passes On

IN the death of President Harding radio lost a staunch friend. And it was but fitting and proper that every radio broadcasting station in these broad United States should close as a mark of respect.

President Harding was one of the first government officials at Washington to become a radio fan and following the conference in 1922 he, along with many others of his cabinet, installed receiving sets in their homes. The receiver used by the President was the last word in reception, and although he had but little time to devote to it, he often spent many precious minutes "fishing" for distant stations and trying to overcome local interference.

The National Press Club, composed of newspaper men in the capital, held a "christening" of President Harding's set last summer, and although the speeches from the nearby government station, which were especially broadcast for the occasion, failed to come through, the President had a good time and gave the news hounds some good advice and not a little inside information on his big job of being chief executive.

It was a fine tribute to the deceased President to have the 500 odd stations of the country remain

silent while the nation mourned for President Harding, who was a true friend of radio. He often expressed the hope that legislation could be enacted to put radio on a sound basis, that laws could be passed to eliminate interference and give the amateur privileges he desired.

HOW come that the reformers haven't discovered what a menace to the adolescent mind is the bedtime story? It is high time they looked into this and ordered an investigation. Stories of the "big, black bear" and "Tom, Tom, the Piper's Son" are being broadcast almost nightly and nobody is doing anything about it. This is terrible! Where are the censors?

Everyone interested in the controversy between the copyrighted music publishers and the radio broadcasters is watching the progress of the newly formed National Association of Broadcasters, which is solidly behind every independent music publisher who contributes his music tax free for broadcasting. These independent music composers and publishers realize the value of the publicity they are gaining and are glad to get the additional advertising.

When radio broadcasting first was taken up many famous singers were loath to perform before the microphone. Now almost every well-known soloist or pianist is glad to.

Winner Is Announced

AS stated in August issue of RADIO TOPICS, the awarding of the \$200 receiving set to the reader making the highest average in answer to the six sets of questions written by Harvey Mitchell Anthony on "Elementary Electrical Principles," is made with this issue.

Mr. Chas. Hoover of Marshalltown, Iowa, attained the highest percentage and is therefore awarded the Zenith set, which has already gone forward. RADIO TOPICS regrets that it was not possible to give every contestant in this interesting contest a Zenith receiver, as many others ran Mr. Hoover a close second for several lessons and then dropped out of the race. High averages were obtained by M. Harrison of Fremont, Neb.; J. J. Brown, Chicago; J. W. Bunn, Fayetteville, Tenn., and B. C. Schaberg, Kansas City, Mo. F. E. Drysdale, Olney, Ill., also deserves honorable mention.

Plans Completed for Another Big Radio Show

Second Annual Chicago Event Will Be Held November 20—Herrmann, Directing Manager; Kerr, Business Manager

THE Second Annual Chicago Radio Show will be held in the Coliseum, Chicago, beginning Tuesday evening, November 20, and closing at 11 o'clock the following Sunday evening. This announcement has just been made by U. J. Herrmann, managing director of the show. James F. Kerr will again be manager.

Plans for the second show are elaborate. The principal change in policy from last year's show will be the throwing open of the exhibit space to distributors, jobbers and retailers, although the show will continue to be primarily a manufacturers' exposition.

The basic program for the show as already outlined will include talks by the foremost radio engineers of the world. The leading hook-ups will be explained by their inventors and master models shown. This plan is expected to bring the largest attendance of amateurs in the history of radio shows and the exhibitors are bound to benefit in proportion.

Special contests for unusual sets, smallest sets, etc., are also being arranged. These contests will be divided into classes which will carry prizes for high school students, amateurs in general and possibly manufacturers.

Business On Sound Basis

"These few who were inclined to believe that radio was through a year ago have now realized their mistake," says Mr. Herrmann. "The industry is just beginning to get itself on a sound basis and from now on the panicky conditions promise to be entirely eliminated. Many believe that the lean periods were a good thing, in a way, because they shook out persons with get-rich-quick ideas who would not have been a help to the future of the industry.

"The general plan for the second annual Chicago show will follow the same lines as last year except that distributors, jobbers and retailers will be permitted to exhibit. Direct sales will be barred, but exhibitors can take all the orders they wish. Deliveries cannot be made in the show for the reason it would be impossible to protect the exhibitors from theft if persons were permitted to carry packages

from the building. We would not be able to discriminate between purchased and stolen articles.

"Our feature program this year will be the most elaborate ever attempted by a radio show. All indications are that this program will bring tens of thousands of persons to the show and every one of them will be a prospect for the exhibitors. The Chicago show is a permanent institution and because of this, first choice in the selection of space will be given to the exhibitors of last year. One thing is certain right now, there will be no vacant

spaces in the Coliseum when the Chicago Radio Show is held this year."

The announcement was also made by Business Manager Kerr that the same general arrangement of booths will be followed this year, except that demonstration stages will be erected at both the north and south ends of the huge building and the broadcasting studio will be on an elevated platform in the center of the Coliseum. The same schedule of rates for space will apply again this year. These rates are on a basis which means that with every foot of space sold the exhibitor is paying less than sixty per cent of the cost of the exposition. "We do not dare to exact a profit from the exhibitor," said Mr. Kerr. "We are confident that the profits can be made from the admission charges paid by the spectators at the show."



BROADCASTS MEMORIAL SERVICES

Outside Calvary Baptist Church, Washington, D. C., where Rev. J. Freeman Anderson conducted memorial services for the late President Harding. The services were broadcast by radio by means of a transmitting station established on a motor truck.

Washington's Giant Broadcasting Station

THE giant broadcasting station "WRC," located at the New Riggs Bank building, 14th Street and Park Road, began a regular broadcasting service on Wednesday evening, August 1. The Radio Corporation of America owns and operates the new station.

Located in the Mount Pleasant district, one of the highest points in the city, where the antenna wires are suspended 150 feet above the street level, the waves radiating from the station have an unobstructed path in all directions. With the antenna system energized by a powerful 500 watt transmitting set, radio reception from the station in Delaware, Maryland, Virginia, West Virginia, eastern Pennsylvania and southern New Jersey should be particularly good, while in the District of Columbia strong signals will be received at all times during the day and evening when the station is on the "air." Radio interest in the district and adjoining states has been markedly stimulated by the new station as reception in this section has been unsatisfactory due to "dead spots" in the ether which act as a barrier between the local receiving stations and broadcast stations in New York and elsewhere.

Washington and vicinity now has adequate radio service, as this powerful station will carry the words of great men in political and diplomatic life, the progress of world events as they transpire and the music of other nations as rendered by visiting musicians to all parts of the United States. This station provides an instantaneous link between the country's political center and every American home and a better understanding of government, of the issues involved in political campaigns, and of the questions which arise in our relations with foreign countries, cannot fail to result from its operation.

Programs Will Be Varied

There is a wealth of material available in Washington from which to make the programs of "WRC" most enjoyable and edu-

cational. At once it is possible that the ceremonies accompanying the dedications of memorials to great Americans, the features of the many conventions held in this city, and the spiritual counsel of the clergy may be carried to the transmitter and set forth so that the whole country may hear and appreciate them.

Momentous events, of interest to the nation, do not, of course, occur every day. The greater part of this station's operating hours will be devoted to the broadcasting of the musical and dramatic talent of Washington and other events of special interest to residents of this city.

Washington is rich in both professional and amateur talent and every effort will be made by those in charge of station "WRC" to arrange programs so that those local interpreters of music and drama may be heard from time to time, not only by their fellow-townsmen, but by citizens of neighboring cities.

Most Complete Studio

The studio, as well as the transmitting apparatus and office, is



COMPOSED FIRST RADIO SONG

Elmer Aichele and William Schmitt, composers of "Somebody Else," which is said to be the first radio song, broadcast originally from WLW of the Crosley Mfg. Co., Cincinnati, Ohio, the home of the first radio play-

located in one section of the building. The studio is acoustically correct in construction and prevents even the minutest echo which might otherwise blur the clearness of transmission necessary to enjoyable entertainment.

The room is a very vital part of the several broadcasting stations of the Radio Corporation of America. Behind several huge panels are vacuum tubes of medium size used to strengthen or amplify the electrical currents which carry voice or music before actually reaching the transmitter. Its use is especially necessary when the program is being brought to the station over a wire a few miles in length, otherwise there would be insufficient energy to materially affect the radio waves. Used in connection with programs taking place in the studio, it is invaluable. The artist may move away from the microphone, may sway closer to it in his earnestness, but by a touch of a knob, the man at the control board can offset these variations.

Close to the operator, and occupying the greater part of the room, are the powerful transmitters. Although but one will be in use at any time, two complete sets are provided, that a reserve unit may be in instant readiness should the active set fail for any reason. It is planned to operate these outfits alternately on alternate days. Either set is the equal, in power, range and clearness, of any now in use, being rated at 500 watts effective output, but if the two sets are combined for the broadcasting of some special event, the range of this station will far surpass that of any other in the country.

Steel Cabinet Protects

Each is complete in itself and contains all necessary tubes, inductions, condensers and transformers, this equipment being mounted behind a large panel and completely shielded by a perforated steel cabinet. This not only eliminates any chance of interaction between the radio and audio-

(Continued on page 38)

Broadcasters' Association Not Worried

Music Bureau Receives Plenty of Good Material From Composers of High Standing

IN the decision rendered on August 11 by Judge Lynch of the United States District Court in Newark, N. J., in the matter of the American Society of Composers, Authors and Publishers vs. Station WOR, technically known as Witmark vs. Bamberger, it is stated that broadcasting stations have not the right to broadcast American Society copyrighted music, unless that right has been secured, but withheld the issuance of a restraining order until his opinion could be passed upon by the United States Supreme Court.

Bamberger's have announced that they will carry this question to the United States Supreme Court.

Ex-Judge Haight, counsel for the American Society of Composers, Authors and Publishers, seems to be sanguine of confirmation of Judge Lynch's decision, upon appeal being made.

Paul B. Klugh, executive chairman of the National Association of Broadcasters, 1265 Broadway, New York City, was in attendance the two days of the case before Judge Lynch, and states that the arguments on both sides were most forcefully and eloquently made by the renowned counsel which the contending parties had retained, and the only conclusion to be reached by a spectator was that a most complete and elaborate attack and defense were made by the opposing parties.

Judge Lynch in his conclusion says "that the broadcasting of the defendant was publicly for profit within the meaning of the Copyright Act, and that meaning has been construed by the United States Supreme Court."

Cites the Shanley Case

Judge Lynch, of course, here refers to the Shanley-Victor Herbert case, where Justice Holmes of the United States Supreme Court decided that although Shanley charged no admission for the vaudeville performance which they furnished, yet the cost of that entertainment was obviously in the price at which the food was sold, and the diner therefore paid just as directly for his entertainment as though the food had been sold at a lower price, and an extra admission fee had been charged for the entertainment.

Many broadcasters will have difficulty in reconciling this Supreme Court decision, because they believe, as ex-Judge Snyder

pointed out on behalf of Bamberger's that there is "no direct pecuniary profit in Bamberger's broadcasting," whereas there was a "direct pecuniary profit" by Shanley, and therefore the Supreme Court decision did not apply.

Judge Lynch, however, has decided that the cases were "within the meaning of the Copyright Act" identical, and he naturally expects his decision to be confirmed by the United States Supreme Court.

Must Have a License

As far as broadcasters are concerned, they are confronted by the Judge Lynch decision, which plainly states in effect that they cannot broadcast the music of the American Society of Composers, Authors and Publishers without taking out a license.

The broadcasters, to meet this situation, have formed the National Association of Broadcasters. Counsel has been retained; Paul B. Klugh took active charge of the affairs of the Association, with the title of executive chairman; offices were established in New York; plans were put into operation for the placing of the new organization upon a practical operating basis; a fund was provided adequate to meet all financial requirements for a period of years, and a constitution and by-laws were adopted containing the following aims and purposes:

To foster and promote the development of the Art of Radio Broadcasting, and the interests of

those engaged in any business, profession or industry relating or pertaining to radio broadcasting; to reform abuses relative thereto; to secure freedom to its members from unjust and unlawful exactions; to procure uniformity, equity and certainty in customs and usages of trade and commerce relating thereto; to settle differences between the members, and to promote a more enlarged and friendly intercourse between members; to secure co-operative action in advancing the common welfare of its members, and proper consideration and concentration of opinion upon questions relating thereto; to advocate the enactment of just and equitable laws pertaining to or affecting radio; to support every movement to advance the radio art, and to encourage and aid in the development of musical and literary genius, especially where such genius has not had proper and just recognition.

Has Bureau of Music

Among other activities, a Bureau on Music Release was established. It is headed by Mr. Raymond Walker, an experienced song writer and publisher, who has a corps of skilled and able assistants. This bureau has invited song writers and publishers to send their music to the executive offices through advertisements in periodicals read by song writers, announcements by members over the air, and thousands of letters sent out. As a result several thousand musical compositions have been received, of varying degrees of merit. These are all put through systematic tests—less than 10 per cent have been found acceptable—but where a song bears evidence of becoming a so-called "hit" and has clean lyrics, it is released by The National Association of Broadcasters.

Since the first of July, this music service has been going out to members of the National Associa-

tion. This music is of as great a variety, and in the opinion of many, of a better quality than that controlled by the American Society.

Members of the National Association of Broadcasters therefore are not worried about the Judge Lynch decision. They are not even interested in it, because they are receiving an ample supply of good music which permanently frees them from any demands similar to those so unjustly made by the avaricious American Society of Composers, Authors and Publishers.

Relay League Meets in Chicago

APPROXIMATELY 1,500 persons, representing all lines of radio activity ranging from amateurs and experimentors to technical men connected with the radio industry as well as authorities of international reputation, will attend the Second National American Radio Relay League Convention, which is to be held in Chicago September 12-15

under auspices of the Chicago Radio Traffic Association, it was estimated here today by committeemen.

Tentative plans for the convention which have just been made public by R. H. G. Mathews of the Chicago Radio Laboratory, central division manager of the American Radio Relay League, call for a program of interest to both the amateur and the broadcast listener. A huge banquet is scheduled for Wednesday evening.

An intensive effort is being made by Mr. Mathews and officers of the A. R. R. L. at Hartford, Conn., to select speakers which will cover all phases of radio transmission and reception bringing before those attending the convention all of the most recent developments which may be utilized for long distance work in the early fall.

One of the most important meetings at the convention on the afternoon of Thursday will be that of the A. R. R. L. Traffic Department under the chairmanship of F. H. Schnell, traffic manager of the League, when coming international amateur long distance tests and kindred matters will be discussed at length.

The evening will be given over to a technical meeting at which time both amateur and broadcast transmitters will be discussed. Tours will be made to local broadcast and amateur stations the following afternoon. Next is another technical meeting on the general subject "Receiving Apparatus." Saturday is to be a "night of mystery" and the convention will wind up with the initiation of candidates into the "Royal Order of the Wouff-Hong."

Canada's New Radio Stations

A grant of \$55,000 has been made by the Federal Government for the establishment of radio stations at McMurray at the end of the steel in Northern Alberta, Fort Simpson, on the MacKenzie River and Dawson in the Yukon, which will displace the telegraph wires at present in use from McMurray northward and into Dawson. The sum voted for the construction of these radio stations is \$55,000, while a sum ranging from \$275,000 to \$300,000 has been voted annually for the last twenty-three years for the telegraph service.



HANDSOME AND PRACTICAL RADIO OUTFITS

(Left), Amrad Console Grand, a de luxe radio receiver, and (right), an Amrad portable receiving set in use out of doors. It is said this receiver will pick up stations 50 to 100 miles on the short antenna shown. The console is a very fine piece of furniture suitable for the best homes. These outfits are manufactured by the American Radio & Research Corp. of Medford Hillside, Mass.

Radio's Steady Progress

A GLANCE BACK AT THE EARLY ATTEMPTS TO TRANSMIT OVER LONG DISTANCES

IN THE early days of radio, following the splendid achievement of Marconi in transmitting the letter "S" across the Atlantic, scientists and engineers in this country and England believed that reliable long distance transmission and reception could be obtained by increasing the power on the antenna and by building higher masts. As much as one hundred kilowatts were used on spark sets and the masts were sometimes 500 feet high.

J. T. H. Dempster, an engineer in the research laboratory of the General Electric Company at Schenectady, N. Y., and a pioneer in the field of radio, explains that the American amateurs are today communicating with English amateurs with 1,000 times less power than was used with indifferent results twenty years ago. "Insensitive receiving equipment," says Mr. Dempster, "was the cause of uncertain reception and it was not until the vacuum tube came into its own that rapid progress was made."

Back in 1904, a few years after Marconi startled the scientific world with his experiment that promised to revolutionize long distance communication, the General Electric Company engineers were actively interested in the new art and they, like others, tried for a long time to offset the shortcomings of receiving apparatus by boosting the power at the transmitting end.

Fessenden Installs Equipment

R. A. Fessenden, formerly a professor at the University of Pittsburgh, and then head of the National Electric Signaling Company, was engaged to install transmitting and receiving equipment at the Schenectady, N. Y., and Lynn, Mass., plants of the General Electric Company, with the expectation that this method of communication would replace the telephone and telegraph lines.

A. A. Isbell, now Pacific coast manager of the Radio Corporation of America, was placed in charge of the installation by Mr. Fessenden. A spark transmitter of the straight gap type was built.

In order to keep the gap from arcing it was necessary to blow air across it at about 100 pounds pressure. The power was supplied by a 20 KW transformer charging a condenser composed of steel plates, separated by glass plates, all immersed in oil in a steel tank. A special relay breaking a very large current in the primary circuit was designed by Mr. Dempster, in co-operation with Mr. Isbell. In operation air was blown across the carbon contacts of the relay. Because of the high potential in the antenna it was possible to draw sparks from any insulated conductor within 100 yards of the masts. The antenna mast was 180 feet high and 96 amperes were used in transmission.

The receiving apparatus consisted of the famous Fessenden liquid barretter or, in better known terms, the electrolytic detector, which was used in connection with the Fessenden interference preventer circuit. The electrolytic detector consisted of a

platinum wire coated with silver. This was known as Wollaston wire. The silver coating gave mechanical strength to the wire, which was less than ten thousandths of an inch in diameter. The nitric acid in a platinum cup into which the wire dipped formed the electrolyte. The platinum cup was the other pole of the cell.

Electrolytic Detector Used

The electrolytic detector was a marked advance over the Marconi coherer but it was still much less sensitive than the crystal detectors now in use. Static frequently burned the point from the platinum wire, temporarily destroying the use of the detector.

With this equipment sporadic communication was established between the two plants of the company during the cold months, but reception was very uncertain in the summer. In efforts to improve transmission, more power was used without improving re-

(Continued on page 34)

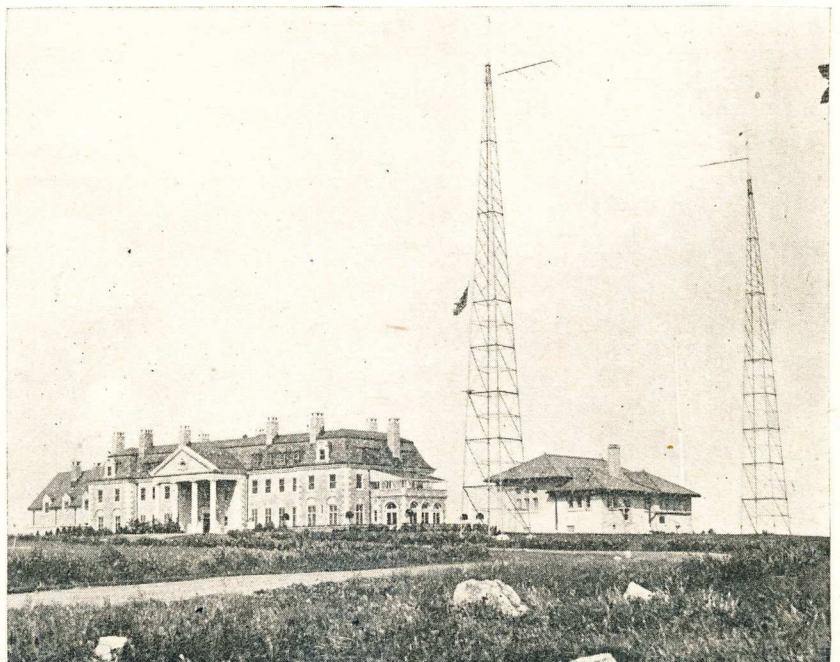

WIRELESS PROBLEMS STUDIED HERE

This is the Green Mansion and WEAf Station, Round Hills, South Dartmouth, N. Y. From this station the entire evening programs of the American Telegraph and Telephone Company's New York station are broadcast daily. Col. Edward H. R. Green plans to make his palatial estate a great clinic for discussing radio ideas, a place for college professors to work out their radio problems. (Photo by International Newsreel.)

True Piano Tones With New Microphone

TRANSMISSION of true piano quality has been a real problem for the radio engineer. The difficulty is similar to that which has confronted the maker of phonograph records. The blows of a hammer on a piano are distinguishable, but the singing quality and the overtones which are relatively weak have not been reproduced through loud speakers or phones.

Engineers connected with the studio of WGY, the Schenectady broadcasting station of the General Electric Company, have devoted a great deal of time to the solution of the problem and they have now developed a device which will make the piano solo a real feature of a broadcasting program.

Magneto Microphone

The device, in brief, consists of a magnetic system between the poles of which is pivoted a suitable coil system. The magnet is firmly fastened to the frame of the piano and the coil is anchored to the sound board. By means of this pick-up device all tones in the piano are faithfully converted into corresponding electric currents which control the radio transmitter. When heard on the loud speaker the piano is no

longer a tinkling sound. The listener gets all the characteristics of this percussion type of instrument—the blow of the hammer, the singing tone of the overtones.

The piano pick-up is free from the familiar hiss of the carbon microphone as well as the objectionable blasting that takes place when an artist plays too loudly for the microphone.

When the carbon or condenser microphone is used to pick up a vocal solo with piano accompaniment the problem is to place the microphone in such a position that it picks up both voice and instrument in their proper ratio. The position of the microphone must be changed for each artist. The radio listener has probably noticed that as the singer's voice increases in volume the accompaniment fades out—in other words, the soloist "paralyzes" the microphone. When the piano magneto-microphone is used the intensity of the piano may be adjusted electrically in the central room, even while the selection is being rendered, as the voice is recorded on the customary carbon or condenser microphone.

Three Devices Used

In the grand piano at WGY there are three of these devices—

one in the extreme treble, one in the middle register and one in the base. These three outputs can be readily balanced in the control room for the best results on receiving sets without tampering in any way with the instrument.

Another feature of the magnetic microphone is that it allows WGY to correct for the shortcomings of the present loud speakers. All loud speakers subdue the sounds of lower frequencies, from approximately middle C on the piano down. To give good piano music for users of the loud speaker it would be necessary for the transmitting station to distort the music from the instrument, making the lower section of the piano several times as loud as the treble. Some stations have actually tried to regrade their pianos to improve them for broadcasting. This means that the music, as heard by the musician at the keyboard, is distorted and the good musician, even though convinced that his radio audience is getting perfect tones, cannot do his best work on a regraded piano.

The magneto microphone may also be used in broadcasting phonograph music where the federal license of the station permits the use of "record" music. When the carbon microphone is used the mechanical energy of the phonograph is converted into sound energy in the usual way and is picked up by the microphone. With the magneto microphone the needle is attached to the coil and the mechanical energy is converted directly into electrical energy without recourse to any sound whatever, thus giving truer production of the record. By proper design and the use of suitable filters in the electrical circuit of the coil a large amount of the needle scratch may be eliminated.



WGY'S PICK-UP DEVICE ON PIANO

True piano tones are now possible when these sensitive magneto-microphones are used. Three of the devices are attached to the piano as shown.

Protects Filament

The addition of an ordinary 25-watt incandescent lamp in series with the plate and telephone receivers of your receiving set will not hinder the normal operation of the set in any way and will protect the filament from burning out in case the B battery is accidentally connected to the wrong terminals.

Adjustable Fixed Condenser

By CHARLES F. FILSTEAD

A FIXED mica receiving condenser is a very cheap thing to buy, but when an amateur is constantly experimenting and building new sets, the cost of even such a small item as fixed condensers begins to count up. Also, many amateurs like to build all the parts of their outfits just for the fun of the work. It is for them that this description is meant. The capacity of this condenser can be changed to any desired value by merely adding or taking away copper-foil plates from each side of the condenser.

First, two pieces of 1/8-inch bakelite are cut to make the top and bottom of the condenser. The bottom piece of bakelite is cut to the dimensions shown at A, and the top piece is cut to the dimensions shown at B. The holes in the bakelite are drilled with a No. 28 drill. The two holes nearest the center of the bottom piece of bakelite are countersunk on the under side, and two 3/4-inch, 6/32, flat-head machine screws are put through these countersunk holes from the under side. The other two holes in this bottom piece are for the wood-screws which are to hold the condenser down, and they are countersunk on the upper side of the bakelite. The sheets of mica insulation are five mills thick (i. e., 0.005 inch thick) and they are cut and drilled to the dimensions given in B. The metal plates are now cut out of thin copper-foil to the dimensions given in C. A larger than necessary number of both mica and copper plates should be cut, so that the capacity of the condenser may be changed.

* * *

To assemble the condenser the two machine screws are put through the bottom piece of bakelite, over them is put a piece of mica, then a copper plate making contact with one of the screws, then another piece of mica, then another copper plate which makes contact with the other machine screw, then another piece of mica

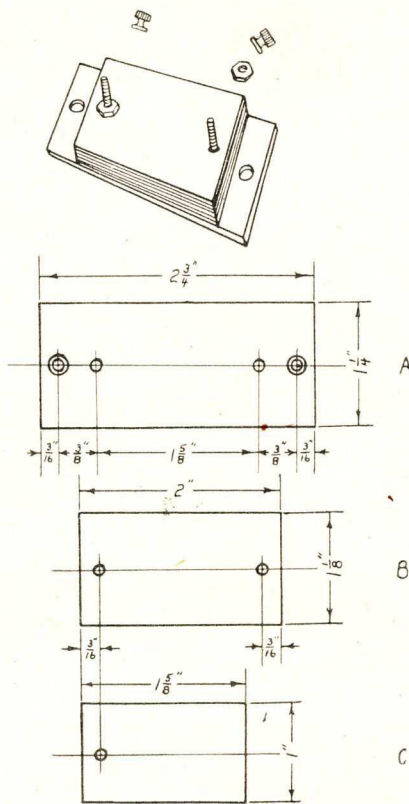

"A" is the bottom plate, "B" the top and "C" the thin copper strips. The mica plates are same size.

—and so on. Care must be taken in assembling the condenser to see that the metal plates are staggered; that every other plate makes contact with the same machine screw. After the right number of copper plates have been put on, a last mica plate is put over the screws, and then the top piece of bakelite is put on, and the whole condenser clamped tightly together by putting nuts on the screws. Two nuts are put on each screw; and, besides holding the condenser together, they also act as binding-posts for the condenser.

Twenty-two mica and twenty-one copper plates will give a capacity of about 0.005 microfarad, although the capacity will vary with the kind of mica used. Two plates of copper and three of mica will give a capacity of about 0.00025 microfarad, which is just the right size for a grid-condenser. The capacity of the con-

denser can be figured by means of the following formula:

$$C = 0.0885 N K \frac{S}{t}$$

Where

C = capacity in micro-microfarads;

N = number of metal plates used minus one;

K = dielectric constant (6.0 for India ruby mica, and 3.0 for Canadian amber mica);

S = active surface of one side of one copper plate in square centimeters;

t = thickness of dielectric in centimeters.

The capacity in microfarads = $\frac{C}{1,000,000} = C_{mfd}$

Using the dimensions given in this article, and taking 4.5 (the mean of 3.0 and 6.0) for K, the formula can be simplified to:

$$C_{mfd} = 0.000249 N$$

whereby the capacity in microfarads can be easily found if the number of metal plates used in the condenser is known.

Hollywood Hears WHAZ

According to word just received at WHAZ, the Rensselaer Polytechnic Institute broadcasting station, the monthly midnight program by Doring's Military Band, including soprano solos by Mrs. William T. Lawrence to band accompaniment, were clearly received at Hollywood, Calif. It is believed that this is a new distance record for summer broadcasting of radio concerts. Station WHAZ holds the record for long distance radiophone broadcasting, made last February when its musical program and announcements were picked up at Invercargill in New Zealand.

Ford Enjoys Radio

Following the weekly program from radio station WHAZ at the Rensselaer Polytechnic Institute at Troy recently, the following telegram from Henry Ford was received by former Mayor Cornelius F. Burns, who has been co-operating with the Detroit manufacturer in the location of the big Ford plant here:

"On board yacht Sialia, anchored off Cheyboygan, in Lake Huron—Greetings from party. Have just been enjoying radio concert and boxing bout returns from Rensselaer Polytechnic Institute station.

"HENRY FORD."

Can You Write A Radio Play?

Here's a Chance to Win \$500 Cash if You Can—Station WGY Wants an Original Radio Drama

THE General Electric Company at Schenectady, N. Y., through its station WGY offers a prize of \$500 for the best radio drama submitted in competition during the three months' period beginning September 1.

The prize-winning play will be presented by the WGY players during the winter months when transmission conditions are at their best and when, it can be reasonably stated, a million people will be listening in. An audience of this size will be the equivalent of the attendance at a 500 night run of a stage production in a theater seating 2,000 people.

In addition to the \$500 prize the successful writer will receive an introduction to a public as large as the reader-circulation of a national magazine and he will have the personal satisfaction of taking a leading part in the development of a new phase of dramatic art. Other plays offered in competition will be produced via the air,

if found suitable, and the author will be remunerated in every case.

One year's subscription of the radio drama by the WGY players has convinced M. P. Rice, director of broadcasting for the General Electric Company, that there is a public demand for this type of entertainment and that the peculiar requirements of the radio drama as compared with the stage and the screen production will in time result in a new form of the dramatic art. The screen has evolved a distinct type of drama which depends solely on the eye for its appreciation; tomorrow the radio drama will be so written that the listening ear and imagination unaided by the eye will be satisfied. It is for the purpose of stimulating and encouraging the development of the radio drama that the General Electric Company inaugurates this prize competition.

The author of the radio drama must place himself in the position of writing for a blind man. The lines of the characters must convey a picture of the scene in which the action takes place. This apparent limitation or handicap becomes an aid to action, however, as the writer need not restrict his play to three, four or five scenes. For example, he can depict an automobile race and carry his audience through its exciting phases by means of the lines. He may take his listener from room to room or floor to floor in a dwelling, if farce or melodrama call for such action. The chase, long a popular feature in the early motion pictures, may be brought into the radio play by means of speech. The radio requires no scenery. No careful search need be made for locations. The spoken words build the scenery.

Dramatic situations may be built up by the speaking voice and through the medium of sound-making devices. The writer is encouraged to make use of sound devices, and the engineer will provide a means of producing through the air a counterpart of the prescribed sound. Rain, thunder, surf, the roar of a moving train, a pistol shot, an airplane, telegraph key or automobile motor may all be reproduced in sound to impart atmosphere and realism.

Those who have written short stories, books of fiction, scenarios or plays, successfully or unsuccessfully, may have the germ of a prize-winning radio drama. If you are interested address: Prize Competition, WGY Broadcasting Studio, General Electric Company, Schenectady, N. Y., for a folder which sets forth the rules of the competition with an outline of the special requirements of the radio play.



REGULAR RADIO HOUNDS

It is claimed these dogs—"Caesar" and "Buddy"—are the original radio hounds. They belong to J. J. Klibert of Burbank, Calif., and are very fond of their wavelengths. The receiver is installed in the yard, and the Newfoundland and Boston Bull both sit and listen by the hour, Mr. Klibert says. They can raise anything in California, even radio hounds. (Photo by International Newsreel.)

World-Wide Communication

ASTONISHING STRIDES MADE IN SENDING MESSAGES TO ALL PARTS OF GLOBE

By FRANK R. CARNEY

THIS is the third of a series of interesting and instructive articles prepared especially for RADIO TOPICS by Frank R. Carney, division manager of the transoceanic department of the Radio Corporation of America. Others will follow in subsequent issues.

ON September 1, just one year ago, the Radio Corporation of America announced the fact that world-wide wireless service would be nationalized, making it possible for the people at all inland cities throughout the United States to avail themselves of this service. Prior to the above date this rapid service was confined to New York and San Francisco, because we had no inland land line feeder.

The public may now file "Radiograms" at Postal Telegraph offices wherever that company maintains offices in the United States, when messages are destined to any city in Europe or South Africa.

Radiograms destined to the Hawaiian Islands and Japan are filed at Western Union Telegraph offices. In other words, the Western Union Telegraph Company connects with the great plant at San Francisco on the Pacific and the Postal Telegraph Company connects with "Radio Central" in New York for points in Europe and South Africa. In filing radiograms the procedure is simple. Radiograms are written and prepared in the same manner as cablegrams. Simply affix the indicator (via Radio) or (via RCA) in parenthesis after the destination. To those who enjoy a charge account the Postal Telegraph Company bill for the service at inland points and the Western Union Company bill for the service to Hawaiian Islands and Japan.

International cable rules promulgated at Berne, Switzerland, govern the checking and general preparation of foreign telegraphic communication. These same rules and regulations apply also to radiograms, whether it be a full paid or fast rate message, a deferred or half-rate message, or week-end message.

All authorized codes may be employed in the preparation of radiograms, and code addresses may also be used. During the past year the word "Radiogram" has become a household synonym and will appear in the new dictionaries. It is here to stay just as much so as was the word telegram, automobile or cablegram.

The regular patrons, as a rule, now understand just what part the Radio Corporation takes in the transmission of a message, say from any inland point in the United States to a point in Europe. When one pauses to realize how rapidly a radiogram is transmitted it is really astonishing. Let us take an average case. Telegraphically speaking, Chicago is

one of the greatest relay centers in the world. It is a great telegraphic heart, so to speak. Wires from Peoria, Des Moines and hundreds of towns and villages all center into Chicago. Radiograms filed at these smaller points must of necessity suffer a slight delay in what is known as the relay. This relay varies according to the "load" or the weather conditions. Under normal conditions the delay is very slight. File a radiogram in Chicago say for Berlin, Germany. From the time the Morse operator transmits it over the Postal wire to New York until it reaches Radio Central at 64 Broad street, is measured in minutes. At Radio Central it is placed in front of an operator who writes your message on a keyboard. The pair of hands manipulating the keyboard in New York controls the machine in Berlin and when he has completed the simple performance of writing your radiogram it is in the heart of Berlin direct without relay. I have personally witnessed a speed of less than two minutes in the transmission of a radiogram from the time it reached Radio Central, 64 Broad street, until the time it was in the office in Berlin. This same rapid transmission is going on day and night between New York-Berlin, New York-Paris, New York-London and New York and Stavanger, Norway, our four great European direct distributing points. Soon the coupling up of New York with Warsaw, Poland; Stockholm, Sweden; Amsterdam, Holland; Rome, Italy; Rio de Janeiro, Brazil, and Buenos Aires, Argentine, will add to the present distributing points.

* * *

One great advantage of radio transmission over that of other means of transmission is the flexibility of the service, in that if we are clear with London, Paris or Norway, and have a heavy load of traffic for Berlin, we simply re-

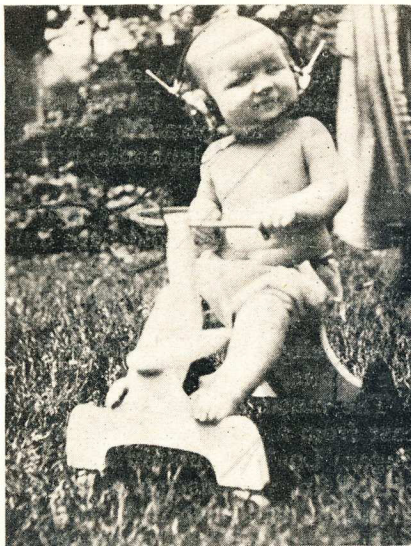

RAISING CONTENTED BABES

This is Joseph Barnes, ten months old, who enjoys nothing so much as a good concert while speeding on his go-bi-bi up and down the lawn.

quest Berlin to meet us on twenty or twenty-five thousand meters, which they promptly do and thereby start a second, third, or fourth circuit, which enables us to clear the traffic, something which cannot be done on cables.

The question has often been asked whether radio could perform as between inland cities. This question may be answered by citing an incident which took place on the night of the recent November elections. Both land line companies were down in the Rockies on account of snow, sleet and static. The Pacific coast cities were eagerly awaiting press news. The press associations appealed to us for help. Within an hour from the time we received the request a duplex circuit between the great plant in New York and the "Big Ben" in San Francisco was put in motion. The coast papers in commenting on the Radio Corporation of America's wonderful performances in this respect gave us credit for transmitting between New York and San Francisco a larger volume of press matter and election news, with greater speed and accuracy, than both land line companies could have done under normal conditions, and this right through the snow, sleet, static, and even the Rocky Mountains, without wires and without interfering with our traffic, San Francisco to Japan or New York to Europe.

Booklet Explains Dry Cells

Considerable misunderstanding still surrounds the proper use of the dry battery on the "A" circuit of radio receiving sets. Much of the information published on this subject has been incorrect and misleading, and many users have been needlessly dissatisfied with that great boon to radio, the dry cell tube.

To aid in spreading accurate and reliable information concerning the proper use of dry cells in connection with the several vacuum tubes on the market, the National Carbon Company has carefully prepared a booklet entitled "The Story of Eveready Dry Cell Radio 'A' Batteries for Dry Cell Vacuum Tubes." The information in this booklet will enable the user to obtain the maximum of service and satisfaction from dry cells. Write for it. It contains much valuable data.

Radio "Bootleggers" in Brazil

HOW would you like to operate a receiver in Rio de Janeiro, where every time you clap on your head set you are apt to land in the hoosgow? Nevertheless, there are ardent radio fans in South America and plenty of them, who are operating under difficulties.

The possession of a receiving set in Rio de Janeiro is either something to crow over or else to leave unmentioned. Since the naval insurrection, Rio de Janeiro has been under martial law and a receiving set, unless duly licensed by the government, is forbidden and is liable to be confiscated.

This regulation applies not only to sending stations, but to receiving apparatus as well, even to the humble and well known crystal set which the small boy installs in the attic.

Since the securing of a government license is necessarily a long and complicated process, illicit or clandestine sets have become prevalent, just how prevalent no one knows. Stores down town display show windows full of radio apparatus, mostly of American make, and coil aeri-als, such as may be set up in the privacy of an attic or bedroom, are featured with suspicious prominence in the displays. A number of illicit sets have been detected and confiscated.

Unlike Buenos Aires, where two entertainment broadcasting stations are in operation, Rio has at present no telephonic broadcasting whatever.

The wireless had first gained an appreciable foothold here during the Continental Exposition when concerts on the exposition grounds were broadcast to the great delight and enthusiasm of the public.

The music having been broadcast from a station on the top of Sugar Loaf Mountain was received in various parts of the grounds and retailed to the crowds through loud speakers.

This served to enlist a good many Brazilian recruits for the wireless bug's world wide army.

One Rio newspaper recently

has taken up the cause of the radio fans and is playing an interesting game of hide and seek with the authorities. It prints photographs of aeri-als, taken across a vista of characterless and unrecognizable housetops; alleges that these aeri-als belong to unlicensed and illicit radio sets; and challenges the police to locate and confiscate them.

New Knob and Dial

The new large knob and dial designed by the engineering department of the Crosley Manufacturing Company, permits tuning the set with an almost micrometer adjustment, and this sharp tuning is much desired by the radio fan.

Most people like to take the outer edge of their knobs and try to get a close adjustment in that way, but with this new knob this practice is not necessary, for the large knob is so constructed with its deep grooved rim, that the fingers get a firm grip and turning is made easy. The markings are in white and form a beautiful contrast to the glossy black of the dial. It is three inches in diameter and sells for 60 cents.

Sings Over Radio at Eighty-Five

Probably the oldest singer ever heard by radio, Calvin Dater of Troy, N. Y., eighty-five-year-old baritone, sang three numbers from the studio of radiophone station WHAZ at the Rensselaer Polytechnic Institute recently.

Mr. Dater, who was for many years a well-known soloist and chorister, expressed a wish to be heard by the wireless broadcasting medium as he recalled the days before most of the modern means of communication, telephone, telegraph, railroads, electric apparatus, automobiles, airplanes, etc., were in existence. Mr. Dater's voice is strong and remarkably firm and steady, and after he sang "Madeline" and "Silver Threads Among the Gold" so many telephone and telegraph requests came to the studio for an encore that he sang the more dramatic solo, "The White Squall." Reports have already come in from points in the middle west as far as Kansas and Dakota, south to Charlotte, N. C., and north and east to Maine and Canadian provinces that Mr. Dater's songs were brought in with remarkable clearness and much enjoyed.

Broadcasting by Wired Radio

By BERT T. BONAVENTURE

NOTWITHSTANDING that the idea of utilizing the transmission lines of a central power station for the dissemination of information and entertainment by the use of radio frequency currents had been advanced as early a date as 1911, it was due to the present chaotic condition as regards the broadcasting situation that the work being done along these lines has received the prominence justly due it.

As the name suggests, wired radio is a method of radio communication, using a wire or system of wires to transmit the signal to the receiver. In space radio, the transmission medium which serves the above purpose is the hypothetical ether. Wired radio is the invention of Major General George O. Squier of the Signal Corps of the United States Army. During the present as well as in past experiments, Maj. Gen. Squier has been an actively interested party.

Compared with space radio, the advantages of the new system of broadcasting are numerous, and in some respects are even so desirable that the new idea has been evolved from the experimental stage and is now being put to commercial use. The possibility of using only small powers to cover relatively large areas is due to the fact that a condition can be obtained where practically no energy is radiated from the system in the form of electromagnetic waves and that the radio frequency current is conducted to its destination instead of being spread out in every direction. In addition outside interference is reduced to a negligible quantity.

Extensive Experiments

Since wired radio transmission is possessed of certain peculiarities, it was necessary to carry out a series of extended experiments before the system would lend itself to reliable commercial operation. Various cities were picked out for the tests, including Cleveland, New York and Washington, D. C. The radio section of the Bureau of Standards co-operated in the last mentioned test. As a result of these experiments interesting data was obtained which later proved of inestimable value.

Regarding the light and power distribution system, some apprehension was felt as to the peculiarities of its character. In most cities the distribution of alternating current follows this general method. At the central power station, the generators deliver three phase current at from 5,000 to 15,000 volts, which is distributed to the various substations at this voltage. A transformation takes place at the

substation which reduces the voltage to between 2,000 and 3,000 volts, also three phase, and this is fed to the various distribution transformers which serve the consumers. At these transformers the voltage is stepped down to 110 volts, single phase. To supply the maximum number of customers with broadcast service, with the minimum possible losses in the intermediate power apparatus connected to the line, the transmitter should be placed so as to operate into the 2,000 to 3,000 volt feeder.

To transmit wired radio over a long transmission line, which provided a direct connection for an unobstructed flow of current from transmitter to receiver, had been a comparatively easy task. But when working over the 3,000 volt feeders, it is necessary for the radio frequency to traverse a vast network of wires, spreading out in all directions and interconnecting at frequent points. Furthermore, the system contains hundreds of distribution transformers.

The question arose, could the high frequency traverse the transformers unaided or would by-pass circuits be necessary around such reactions? Only experiment could settle the question and it did. It proved possible, with no changes to the distribution system and with a slight amount of assistance to the radio frequency currents, to obtain sufficient energy at the far end of the line to satisfactorily operate a crystal receiver plugged into the electric lighting circuit. Only low transmitting powers were required.

Very Little Lost Energy

With the proper choice of wavelength for any given installation,

practically all of the energy transferred to the line is directed to its destination by conduction along the wire and no appreciable energy by electromagnetic radiation from the system. It was expected, from a study of the theory of wired radio transmission, that the attenuation undergone by the transmitted current would increase with decreasing wavelengths, and to cover a given distance on shorter wavelengths would require abnormally large transmitting powers. By actual test however, the use of extremely long waves gave remarkably poor results and further, it was found that an optimum wavelength exists at which the desired results are obtained, i. e., no appreciable radiation into space and the ability to cover the necessary distance economically.

During the tests on one line, short wavelengths up to 710 meters produced excessive radiation, as evidenced by reception on a distant antenna, while a wavelength of 13,000 meters gave poor reception, both by wired radio and on an antenna. In this case it is clear that the wavelengths chosen were ill fitted to fulfill the required conditions of successful wired radio transmission. However, a wavelength of 3,800 meters gave the most gratifying results, excellent wired radio reception being obtainable with practically nil reception on an antenna, showing that no radiation was taking place.

Not infrequently, when using short wavelengths, "blind spots" were encountered. No reception was possible at these blind spots, due apparently to the reflection of the high frequency wave by power apparatus on the line, thus creating standing waves where maximum reception was obtainable at the loops and nil reception at the nodes. A small change in the transmitter frequently seemingly had no effect on moving the position of these loops and nodes.

On short wavelengths, the transmitted energy undergoes a very rapid attenuation and consistent results over given distances cannot be had. By using intermediate wave-



COOKING BY RADIO

Many a housewife bakes cakes, pares the potatoes and prepares the dinner while listening to information sent out by the Postoffice Department concerning the latest prices of foodstuffs. Later in the day she tunes in the correct time, gets the evening concerts and hears the last minute news of the day. The above photo is Mrs. Gilbert, of Washington, D. C. (Photo copyright by Underwood & Underwood.)

lengths, both of these undesirable features are avoided.

Due to the high impedance of the wired radio circuits to 60 cycles, the lighting line does not interfere with either the transmission or reception. Since the line voltage is generally 110 volts and the reactance of the wired radio circuits to low frequencies of the order of 60 cycles is approximately 1,000,000 ohms, the current flow under these conditions would be very small. However, the radio circuits offer a zero reactance to the high frequencies of the transmitter, due to the use of series tuning.

Of transmitting circuits several were tried as well as different methods of connecting the receiver to the line. Two tuned protective condensers serve to couple the transmitter to the line. Practically, it does not matter which two of the three phase the high frequency current is fed into. Only one of the three phases is used in receiving, and the ground connection, made in the ordinary manner is also used. Other circuits, both transmitting and receiving were tried with favorable results in most cases.

May Operate Several Sets

Different signalling frequencies may be employed, thus permitting the simultaneous operation of a number of transmitters and receivers. Experiment proves that the distribution system is not disturbed from its normal functioning

when high power, high frequency energy is fed into it. Nor is the associated apparatus subjected to any damaging influences.

A wired radio broadcasting station is now in operation at the Livingston power house of the Richmond Light and Railroad Company, Staten Island, N. Y. Receivers, both crystal and vacuum tube, have been developed especially for use on the company's electric light lines. A variable condenser is the only control, as the receiver was essentially designed to receive but one wavelength. The uni-control takes care of slight variations in the transmitted wavelength. As to the vacuum tube receiver. A brass housing holds a three-tube duplex circuit, i. e., one tube functioning both as an audio and as a radio frequency amplifier. The lighting circuit may be used to supply the necessary current and voltages for the operation of the receiver, or storage batteries may be used. In the base is incorporated a loud speaker, the fibre horn of which protrudes through the metal casing around the entire unit. To comply with the Underwriter's rules, special insulation has been used throughout the two receivers. A shock cannot be received from the head receivers.

At the Staten Island installation, provision has been made to re-broadcast news and entertainment sent out by the local broadcasting

stations. A loop receiver equipped with sufficient radio frequency amplification, picks up the signals and upon being further amplified at audio frequencies, the signal is fed into the modulating system of the wired radio transmitter. This receiver may be disconnected from the transmitter by a system of jacks and plugs and local announcements and lectures may be broadcast over the lighting system.

The company rents either type of receiver on the basis of a small monthly payment. Should the consumer so desire, the outfits may be purchased outright. The operation of the system is thoroughly reliable and the cost of erecting an outside antenna is dispensed with, in addition to the trouble in looking after it. All the necessary power for the operation of the sets can be drawn from the lighting line at small cost.

As a means of earning and retaining the good will of its consumers, wired radio can be turned into an exceedingly useful tool in the hands of a public utility company.

Hears Radio Sermon on Deathbed

AN aged resident of Trumansburg, N. Y., on his deathbed, listened-in with members of his family to a radio sermon delivered by Rev. G. A. Bierdemann, pastor of the Trinity Evangelical Lutheran Church of Albany, N. Y. The sermon was broadcast from WGY, the Schenectady station of the General Electric Company. Thomas J. Carman wrote WGY of the reception of the sermon by his father-in-law.

"My father-in-law, who is past 90, is on his deathbed, and although he can live but a few days, he still has all his faculties. He has always been a sincere Christian. Yesterday morning I asked him if he cared to hear a sermon. He said he did. We moved the receiving set to his bedside and we all listened to the Rev. G. A. Bierdemann's sermon through your station. After the service father said he heard every word. His wife and I also listened in. Had Dr. Bierdemann prepared his sermon especially for us he could not have made it more comforting."

Department of RADIO ENGINEERING

Radio Topics Institute

Nanko C. Bos, Chairman Advisory Board



Look for the Approval Seal

Such as the one just above which are furnished manufacturers whose radio merchandise has been tested and approved by the Institute Laboratory. We urge you to purchase only such apparatus, for it carries the guarantee of our organization.

Send all inquiries and material for test, calibration, or reconstruction to RADIO TOPICS INSTITUTE, Oak Park, Ill.

That Single Dry Cell Set

By C. E. BUTLER

SO MANY requests have come in for the hookup shown in our June issue, as built by Mr. V. M. Moen, St. Paul, Minn., that this article is devoted to a description of the set and instructions how to build one.

The hookup and parts used in Mr. Moen's set are the same as the Aeriola Senior so I will confine my article to the latter one. The form of the Aeriola Senior does not have to be followed in assembly, although it is extremely compact and well built, and the apparatus may be assembled on an upright panel as Mr. Moen has done.

The circuit has one or two distinct features that are out of the ordinary. One is the fixed antenna series condenser, or condensers, which take the place of the usual variable condenser in the antenna or ground lead. The two condensers may be of the usual mica type of .00025 MF.

capacity connected in series with a binding post for connecting the antenna in series with one or both condensers as shown in the diagram. One binding post then can be used for short waves and the other for long wave receiving. This simplifies tuning consider-

able and is just as efficient for the variable part is taken care of by the grid variometer. Since the change in wavelengths brought about by the new government regulations it may be necessary to connect the binding post not in use to the ground in order to reach some of the stations sending above five hundred meters.

Fixed Ticker Is Used

The method of securing regeneration is unusual in that a fixed

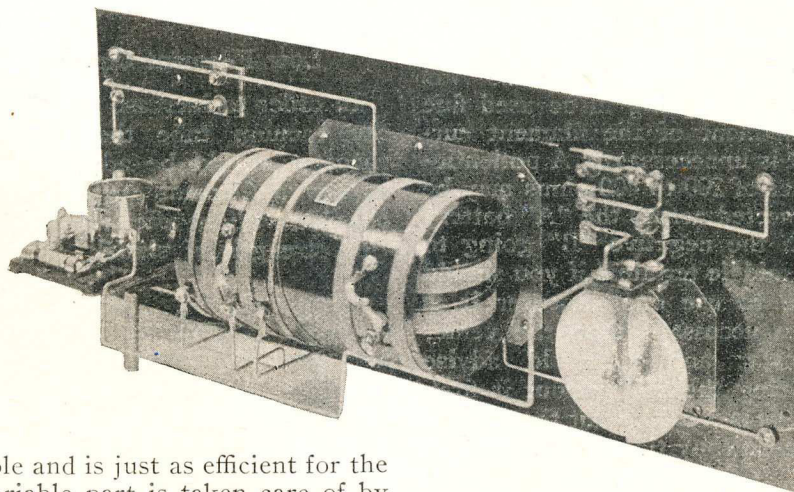

able and is just as efficient for the variable part is taken care of by the grid variometer. Since the change in wavelengths brought

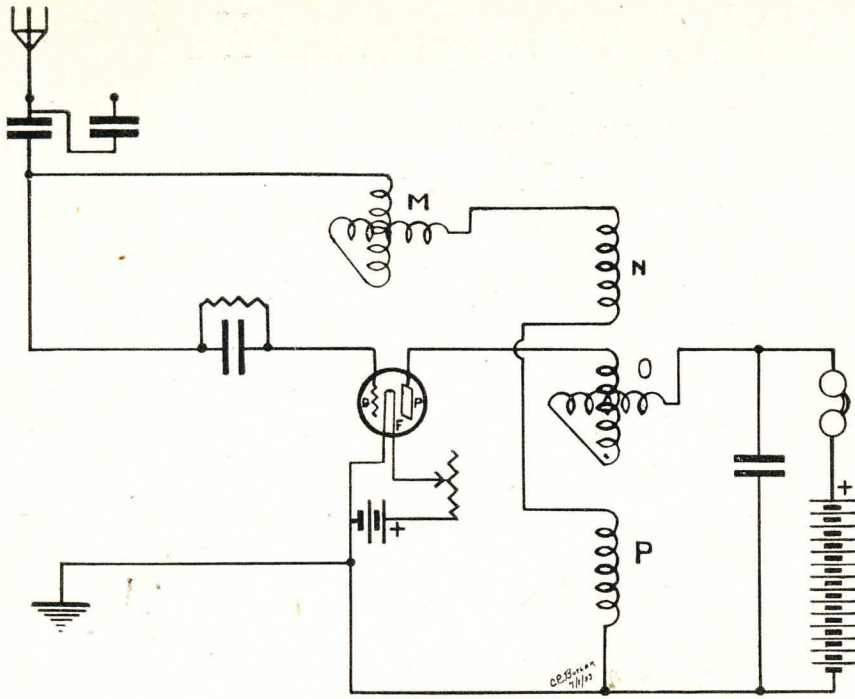

tickler is used in addition to the regular plate variometer. This feature gives a very strong oscillation produced by means of the tickler feed back together with the very gradual control of regeneration and oscillation common to the variometer tuned plate circuit. This method is employed in but two sets on the market today, one the Aeriola Senior as above mentioned, and the other the Colin B. Kennedy apparatus.

The circuit employs two variometers for tuning purposes, one in the grid and one in the plate circuit, and no variable condensers are necessary. Elimination of controls has reduced the number of adjustments to three; the two variometers, and the filament rheostat, which is unusual in the average tube set. A venier rheostat may be used but if the WD 11 tube is going to be used fine adjustment of the filament current is unnecessary. A potentiometer of 200 to 400 ohms may be connected across the "A" battery with the negative "B" going to the middle terminal if you should wish to use one, however it is more necessary than the venier rheostat and I would advise building the set without it first, as this is a refinement that can be added at any time later.

Tuning is simplicity itself. Turn the rheostat on until the filament in the WD 11 tube is a

cherry red when viewed through the top of the metal structure of the tube.

Rotate tuner variometer dial slowly back and forth over the scale. If no signal or music is found increase the amplification by tuning the plate variometer to increase regeneration at the same time rotate the tuner dial. If by this time no signals have been found it is an indication that no station within range is transmitting within the wavelength range of the antenna post used, or something is wrong with the assembly or installation of the apparatus. Try again by connecting the antenna to the other antenna binding post and hunting for signals as before.

Low Filament Current

In order to increase the life of the vacuum tube the filament rheostat should be adjusted for as low a filament current as is possible without affecting quality or strength of signal. While a

relatively strong station is being received adjust the rheostat to a point where the strength of signal starts to fall off if the current is further lowered.

The tickler or plate variometer dial is used to adjust the regenerative amplification of the signals. Care should be taken not to use too much regeneration as this tends toward increase in distortion, noises and static. If the tickler adjustment has little effect on local stations it indicates that your antenna is too long.

At a certain point the receiving set starts to oscillate, above which any increase in tickler adjustment will not increase the strength of signal.

Adjusting for Reception

The proper adjustment depends upon the strength of signal. With very strong signals the tickler will be of little or no value. When amplification for weak or distant signals turn the dial until the desired strength of signal is obtained. If too much is cut in the set will start to oscillate and the music or speech will become distorted, noisy or mushy. When this occurs immediately cut out some of the plate variometer until signals again become clear. When your set is oscillating remember you are undoubtedly causing interference in other receiving sets in your neighborhood as your set is now a miniature transmitting station.

The set may be constructed with two variometers, using six turn coils, one on each side of the plate variometer, or the whole may be wound on a single piece of bakelite tubing as shown in diagram.

Complete details of the construction of the inductance unit will appear in RADIO TOPICS for September together with assembly of the set with one stage of audio frequency amplification.

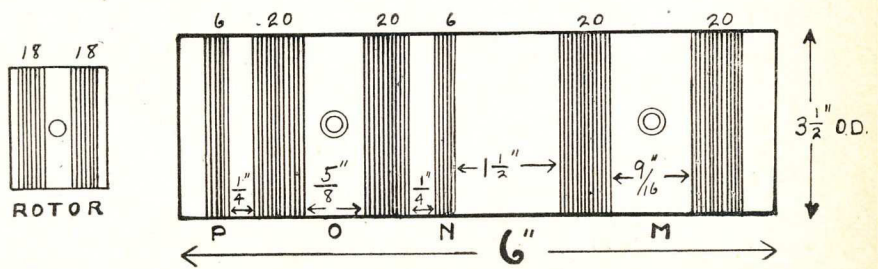

CORRESPONDENCE WITH THE INSTITUTE

Conducted by Carlton E. Butler, Mgr. Radio Division, Service Department, Westinghouse Electric & Manufacturing Co., Chicago, Ill.

Mr. Butler will answer any questions puzzling Radio Fans. Make your letters as short as possible, write on one side of the paper only, and give your name and address plainly. In conjunction with questions and answers in this Department, an article will appear elsewhere in this magazine each month dealing with particular phases of trouble experienced in assembling and operating radio receiving sets by a great number of our readers. Save these articles, as they may answer many of your questions and prevent you from making costly mistakes in the future. This is your Department. Use it.

In one of your issues of RADIO TOPICS, to which I am a subscriber, early last winter you published an article on the construction of a single tube receiving set, similar, I believe, to the Chicago Radio Laboratory, "Zenith" set.

I have built several of these sets and they all work great and when others won't. In the last six months, with a UV 201-A or 200 tube, I have logged about 115 broadcasting stations from Medford Hillside to Los Angeles and Portland, as well as Canada to the Gulf. Also the change in wavelengths does not bother me—can reach out 300 miles at noon.

I hear RGY and the closer stations with volume equal to most detector one stage outfits. With an indoor aerial I hear most of the stations with sufficient intensity to enjoy. Am using two aerials, one of them only sixty feet long and fifteen feet high. Results are very good. It is entirely screened also.

I have lost this particular copy of RADIO TOPICS and am enclosing 25 cents for another copy. If you are out of them please give me the details separate.

Have built one stage radio frequency and two audio in one of these sets and get exceptional distance and volume.—C. R. WILLIAMS, Janesville, Wis.

ANSWER: It is difficult to identify the hookup you are referring to, but am enclosing what I consider very good and recommend that you try it. The writer would appreciate a reply from you, if you try the hookup, giving your opinion of it.

You seem to be having excellent results with your present apparatus, but, like the most of us, you like to seek a better hookup. Good luck to you.

I have been reading RADIO TOPICS for some time and am real pleased with it. Enclosed find my check for \$2, for which mail RADIO TOPICS to my address for another year beginning with the July number.

I am also sending diagram of a set which I made myself. Please give me a diagram for adding two steps in a separate box and also the best transformers to use with Cunningham tubes. EWING C. DALY, McKeesport, Pa.

ANSWER: We are mailing you diagram for adding two stages of audio frequency to your present set. Our position pre-

vents us from recommending any one particular make of transformer, however, there are a number of excellent ones on the market. It is recommended that you use a 10-1 ratio on the first stage, and a 3-1 on the second stage.

I am a reader of that wonderful radio magazine "Radio Topics." Will you please send me a hook-up using a Multi-Range coupler with a detector and two stages of Audio frequency amplification, and I would also like to know how to build a battery charger; I would like to get this hook-up as soon as possible, as I have all of the parts.

Thanking you in advance, I am, Your reader, W. H. RYLAND, Washington, D. C.

ANSWER: In response to your recent letter we are mailing you hook-up for Multi-Range coupler with two stages of audio frequency amplification. It will be impossible to comply with your request for a hook-up of a battery charger unless you tell us what material you have and what kind of charger you intend to build.

What is the wave length of the Reinartz Tuner? What can I do to increase my wave length? Yours very truly, F. R. KAFTAREK, 212 Washington St., Chicago, Ill.

ANSWER: The wavelength of the Reinartz tuner depends upon the construction of same. Adding more turns of wire to the tuning inductance, and adding a variable condenser in parallel with the primary inductance will raise your present wavelength.

I am making a loose coupler using a tube 12"x6" as the primary and 12"x5" as secondary. Is the size of the secondary in proportion to the primary large or small?

The primary has 140 turns of No. 14 double cotton wire which covers 11 inches of the tube. Is the wire of a right size or not?

In proportion to the primary tube how many turns must I use on the secondary using No. 22 double cotton wire?

On the primary I use two slides, one for the aerial and one for the ground.

In winding the secondary tube, where must I begin my first tab, at the end

where the buttons come or on the other end? Also how many turns to the first tab, up to the second tab, etc. In connecting the tabs to the buttons where must I begin from, A or B? Also where does the single wire that I started with get connected; also the wire that remains at the end?

In winding the secondary tube how can I arrange it in order that it will enable me to get local stations on a high length, also DX stations?

About how many meters can such a coupler have?

Will I get the same results in making a loose coupler that is 10" in length using No. 14 wire. The reason I use No. 14 wire is that it does not wear so easily and that I am told it produces louder tones.

Is it possible to make a loose coupler that is stationary, that is without pulling the secondary in or out?

Kindly advise me by return mail, as I am a subscriber of your magazine. Enclosed you will find a stamp. Thanking you in advance, I remain, Yours truly, D. RINGA, 1913 Lexington Ave., New York City.

ANSWER: For broadcast reception your tubes are rather large, but according to the size wire you are using the proportions are about right. A 3½ inch primary and a 3 inch secondary tube 6 to 8 inches long will suffice. Would advise that for convenience you use No. 20 or 22 wire, either cotton, enamel or both.

The primary will work with 75 turns, the secondary with about 100. Adding more turns will decrease the efficiency of your coupler due to dead-end losses, although it will enable you to tune to higher wave lengths. If you care for broadcast reception only 600 meters will be as high as you will care to go. The No. 20 enamel wire works satisfactorily for the primary and will not loosen under the action of the sliders if wound on tightly and coated with varnish or collodian.

In winding the secondary begin at the end opposite the switch, taking a tap at the fortieth and every tenth turn thereafter. It is immaterial at which end of the row of switch points you start to connect, however, it is well to have them in rotation. Do not break the wire when taking taps, but bend a loop in the wire and continue winding, scraping the insulation off from the loops later and soldering your leads to the switch contacts on to the loops. Am drawing diagram at bottom of page to illustrate this.

If the coupler when completed will not reach the higher stations, place a variable condenser across either the primary or secondary of your coupler. DX stations will come in at the same setting nearly that the local stations do and their reception is dependent upon the quality of your tube and the overall efficiency of your installation rather than any additional wave length.

It is possible to make a coupler that is stationary, doing your tuning by switch levers and switch points together with variable condensers placed across the primary and secondary.

Many Improvements in New Crosley Model XJ

WHAT is the best season of the year for radio? Winter? Perhaps, but for the radio engineer and experimenter, the summer is the best season for radio because the conditions for radio reception are not always ideal.

During the summer of 1923 the experimental department of the Crosley Manufacturing Company conducted a series of practical tests with radio apparatus and from these tests there was created the new Model XJ. On one hot summer evening the powerful WLW station was broadcasting its program and yet within three miles from the studio the engineers of the Crosley laboratory were successful in tuning out that station and hearing one in Omaha, Neb., on a loud speaker without the slightest interference from the local station, a thing that even the Model X could not do so well.

This new Model XJ utilizes the Crosley tuned radio frequency circuit. This is the same circuit which was used in the Model X, the receiving set which made possible the hundreds of letters and telegrams from radio fans all over the country and especially from the static zones near Florida where some of the owners of this model heard Honolulu several times. Except under the most adverse conditions, the owners of this model have heard stations from coast to coast. Now, however, comes the new Model XJ with its many refinements that will enable the owner to get even greater service, it is said.

Incorporated in the new Model XJ is the Crosley Multistat, with its molded shell rendering a smooth ball-bearing contact and graduated resistance wire to accommodate any type of tube, adding to the appearance and efficiency of the set. The new molded sockets of a composition approved by the best radio engineers and the new radio frequency tuned amplifier coil with its unique low resistance winding makes it possible to tune out local interfer-

ence, a thing the Model X has been noted for.

The new Model XJ is equipped with a phone jack, so that it is now possible to plug-in on one-stage of radio frequency, detector and one-stage of audio frequency for head phones. Removing the phone plug, automatically switches to the loud speaker binding posts, which is always connected from the rear. Binding posts have been eliminated from the front of the panel, so that all connections, other than the phone plug, are made from the rear, eliminating unsightly wires from the front of the table.

A filament switch has been provided, so that the tubes can be turned out, leaving in tune any station, and eliminating the necessity of disconnecting battery clips or turning out the rheostats.

New knobs and dials have been provided and the large tuning knob is so grooved and designed that vernier adjustment may be made with ease. These large dials and knobs are placed on the tuning condensers.

Through the use of Crosley variable condensers, with their low internal resistance and freedom from body capacity effects, the famous Crosley tuned radio frequency circuit, has been greatly improved in the Model XJ. The first successful method of control of radio frequency amplification originated in the laboratory of the Crosley Manufacturing Company. This circuit makes it possible to tune sharply to any wavelength between 200 and 600 meters, a thing impossible with transformer coupled radio frequency amplification.

This new Model XJ is a four-tube set, consisting of one-stage of tuned radio frequency detector and two-stages of audio-frequency amplification. It is suitable for use with storage battery or dry-cell tubes. All of the units are mounted upon Formica panel, with sub-post panel of the same material. Heavy bus bar wiring is used throughout, making the set substantial for shipment. The

panel is mounted in a solid mahogany cabinet, natural brown, rubbed mahogany finish.

Doings of Radio Fans in Milwaukee

THE first meeting of the Milwaukee Radio Amateurs' Club, Inc., following the annual summer recess, will be held on Thursday evening, September 20, at 8 p. m. in the trustees' room of the Milwaukee Public Museum. One week later the society, which is over six and a half years old and is now a non-stock corporation, will hold its annual corporate meeting, at which there will be an election of the members of the board of directors. The newly selected directors will then appoint the five general officers and the committee chairman.

At the several mid-summer meetings of the present directors, extensive plans were formulated for a fall membership campaign. Not only radio amateurs living in the city of Milwaukee will be invited to join the club, but all those residing in the city's suburbs and surrounding county. The society has long been affiliated with the American Radio Relay League and in reality is a local section of it; therefore all of the A. R. R. L.'s local members will be solicited as well as licensed radio amateurs. The club is primarily one for amateurs, but membership is open to others interested in radio, particularly to technically inclined broadcast listeners.

A lecture program is being arranged for. The committee in charge promises to present to the club during the course of the season some of the best known amateurs in the country as well as several high league officials and men in the commercial side of the radio field who have a known reputation as designers and manufacturers. Traffic discussions and means to reduce any local interference that there may be will receive the attention of some gatherings of the members.

Radio vs. Motion Pictures

ABOUT a year ago a great cry went up from the theatre managers condemning the radio. It would hurt their business they were sure because nobody would go to the theatre if they could sit at home and have their amusement delivered through the ether. Of late, however, there has been quite a reversal of form with regard to radio as a competitive medium and many alert theatre men are taking advantage of the opportunity to tell the world about their pictures and musical programs. The following interesting article is from the Exhibitors' Trade Review, and is headed "Radio—Will It Help the Theatre—Problem Industry Wants Settled?"

THE great wave of popularity on which radio broadcasting is still riding and which is a form of amusement newer than motion pictures but reaching the same people, the masses, is attracting the attention of the motion picture industry, especially the theatre owner.

Does it endanger the popularity of the motion picture; is it a profitable method of theatre advertising; is it making people who would otherwise attend theatres stay at home, are questions being asked. There is no evidence yet that it has reduced attendance at theatres while there is evidence that it has aroused new interest in theatres broadcasting their musical performances and giving concerts.

While we are not privileged to give the name of the motion picture theatre which has carried the experiment to the most advanced stage, it is a fact that one theatre which has been broadcasting a Sunday performance and then giving an evening concert has received thousands of letters which not only commend the theatre for its splendid performances but which actually state that the writer, although never before in this theatre has been converted into a steady patron.

This is the first direct evidence of the possibilities of radio broadcasting as a means of bringing new people into theatres and making new friends for it and for the motion picture. A theatre manager of long and successful experience who has conducted experiments with radio answering the objection that people who write to the theatre promising to attend never do attend says:

"The motion picture theatre is in a peculiarly favorable position with respect to broadcasting. Its chief form, or entertainment, the picture, cannot be transmitted through the air—yet—and if people who hear the radio concert like them in radio form they must actually attend the theatre to get the picture and my experience thus far is that they do come and that they have increased the business at this theatre.

"Then also the most rabid radio fan does not claim that the musical program on the air is as perfect as that given in the theatre and that thousands of radio fans attend the theatre to get the original music and to see the performers who have been broadcasting."

The theatre broadcasting experiment referred to is having a tremendous vogue, which is due not only to the fine program rendered but to the

talent of the theatre manager, who, gifted with a fine sense of humor and a good radio voice, has made thousands of friends whom he has never seen. He always mentions his theatre, on the air, of course, tells about the coming pictures and introduces the performers so the advertising advantages are many and he never fails to take them.

Describes His Pictures

At 7:20 each Sunday evening he "takes the air" and describes the regular theatre performance which is about

room in this case happens to be the private screening room.

An interesting feature of this broadcasting experiment is that the heavy expense is not borne by the theatre. The equipment is installed by the broadcasting service. It is compact equipment which is hooked up to the main broadcasting station.

The possibilities in the use of radio broadcasting by a film producer was demonstrated in New York recently when Elmer Clifton told about his whaling film at the Cameo Theatre over the air route. He told his audiences that he would like to send them a booklet about the whaling industry and the film. In the days following he received thousands of letters asking for the booklet, and it was reported, the radio talk helped swell receipts at the Cameo Theatre.

Theatre Drums Up Trade

George Schade, owner and manager of the Sandusky, Ohio, playhouse bearing his name, has a new way for drumming up holiday attendance. That

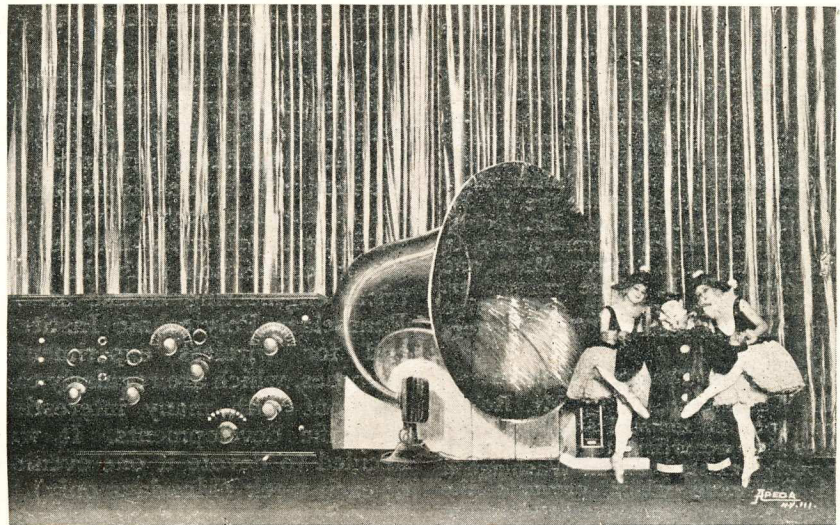

THEATRE USES RADIO PROLOG

In celebrating its entrance into the field of radio the Strand Theatre, New York City, staged a presentation using a huge radio outfit as a background for the picture "The Isle of Lost Ships." The radio idea was most appropriate because of the nature of the Associated First National picture, introducing the radio angle in the ocean-wide search of one of Uncle Sam's torpedo boats.

to be broadcasted. He describes briefly the operatic impressions to be given. All this is done from a microphone near the stage, and without interference with the performance in the theatre. The performance is then given and frequently the manager during a short subject film will describe various shots on the screen. The complete musical program, a half hour of music is then given, a microphone hanging in the auditorium about 20 feet from the orchestra pit transmitting the performance.

About 8:15, selected artists from the regular performance are taken into the private broadcasting room where the evening concert is given. The concert

is by giving a jazz orchestra concert and having it sent over a wide radius by radio in conjunction with the Sandusky Register and the Ohio Bell Telephone Co. The public service commission got the equipment in for it and the Register supplied the publicity and free advertising for the telephone company, the concert and the theatre.

All that Schade had to pay for was the orchestra and he had arranged to have that anyway. It helped build up attendance for the theatre both during and after the holiday to such an extent that he contemplates a similar event on future holidays. The argument that such a concert might compete with the box-office itself was

disproved, according to Schade, by the increase of attendance that resulted after the first radio waves went out.

Radio as it affects the theatre is yet too undeveloped for use by the small operator but it is probable that before many years the small owner may, if he desires, follow the footsteps of the big operators.

Strand Finds It Useful

The Strand Theatre, New York City is the latest New York house to follow the lead of the Capitol. Strand musical numbers are now being broadcast regularly.

Dave Love, conductor of the Palace orchestra at the Palace Theatre, has brought down a large amount of publicity in the Memphis papers by his very novel and decidedly attractive prologues, his prologues and the community concerts held over Sunday afternoon and to which the public is invited. But now he has gained the limelight on a new count. He staged a Radio Week at the Palace and introduced a novelty—broadcasting and receiving at the same time. The Palace orchestra played very softly but the sound was caught by the microphones and carried to WMC, the Memphis broadcasting station, from which it was relayed to the Palace theatre and amplifiers placed at intervals through the theatre caught the sound. The sound from the amplifier was much stronger than the orchestra was playing and the effect was novel. The innovation met with public favor and Radio Week was a huge success.

What is considered to be proof that exhibitors are fast losing their opposition to radio is shown in the statement made by J. G. Rohlfs, short subject Sales Manager for the W. W. Hodgkinson Corporation. Mr. Rohlfs has recently returned from a trip to Washington, D. C., Boston, Mass., and Providence, R. I., where unusual tie ups have been made in conjunction with the one-reeler, "The Mystery Box."

Washington Theatre's Experiment

In Washington, D. C., Mr. Rohlfs came upon an unusual situation. He states that according to scientists an air pocket exists between Washington and Baltimore which prevents the transmission of messages between the two places. The matter was brought to the attention of the Radio Corporation of America and as a result an extra large broadcasting station has been built.

During the running of "The Mystery Box" at Loew's Palace Theatre, Washington, D. C., arrangements have been made for a special broadcasting to be made with an amplifier on the stage of the theatre which will operate during the running of the picture. At the same time The Washington Post will run a scenario contest. According to Mr. Rohlfs, this tie up is unusual inasmuch as the Radio Corporation of America, The Washington Post, and Woodward and Lathrop Department store have provided an unusual tie up on a one-reel film.

At Boston, where "The Mystery Box" opened at the Park Theatre, a similar tie up was made. The Radio Corporation of America in this instance installed a receiving set on the stage of the theatre and sent a man to operate it. A radio concert was given during the run. At the same time

John J. Fanning, director of broadcasting, who has the distinction of being one of the best announcers of radio programs in the country today, broadcast to over 300,000 listeners all about the film appearing at the Park Theatre.

A similar tie up was also secured in Providence, R. I., with Shepard's Broadcasting station and the Majestic Theatre. This station will not only broadcast into the theatre at night but will do so for every performance beginning at noon until the theatre closes.

Station WHAZ Has Birthday

RADIOPHONE station WHAZ at the Rensselaer Polytechnic Institute, Troy, N. Y., the oldest engineering college in America, will celebrate its first anniversary Monday evening, September 10, with a program by the same group which presented the first program when this station was opened a year ago. Dr. Palmer, C. Ricketts, president of the institute, will deliver a brief address.

Station WHAZ has already performed many unique feats. Installed through a gift of \$30,000 by the Roebings, graduates of the institute, famous as the builders of the Brooklyn bridge, this station was primarily intended for use in connection with the electrical engineering course at the Rensselaer Polytechnic Institute and for wireless experimental purposes, which are regularly carried out with many interesting scientific developments. It was decided to devote it one evening of each week (Mondays only) to the entertainment of the radio audience, and during the cooler season its programs, which run the whole gamut of entertainment and instruction, are heard regularly from coast to coast, from Alaska to Panama, in Hawaii, Cuba and at sea.

WHAZ was one of the first stations in America heard in continental Europe last November. It was the first eastern station heard in Hawaii last December. This station established the long distance record of the world in February, when test early morning programs were picked up on four days at Invercargill, New Zealand, a distance of 10,000 miles from Troy, farther than the human voice had ever been carried before without wires. It ac-

complished the first transcontinental two-way radiophone transmissions in January and February with station CFCN at Calgary, Alberta, Canada, with programs and messages interchanged simultaneously. A new summer distance record was made in June when a midnight concert by Doring's Band and soprano solos by Mrs. William T. Lawrence were clearly heard in complete form at Hollywood, Calif. Even during the periods of greatest static interference reports show that its programs are heard with remarkable clearness as far west as the Rockies, south to the Carolinas and throughout the eastern Canadian provinces.

In physical equipment station WHAZ is very similar to several other large stations throughout the country, operating a 500-watt Western Electric broadcasting equipment, though its location on top of the big Sage Laboratory on the crest of the hill-top campus above the city is an ideal one. Its remarkable success, however, is credited to the superior technical skill of the electrical engineering experts in charge of the operation of the station, all three of whom were pioneers in the wireless operating field and have constructed, tested and operated all manner of wireless sending and receiving apparatus. Prof. Wynant J. Williams is the engineer in charge with two instructors of the Electrical Engineering Department of the Institute, Harry R. Mimno and Leonard J. Inskip, as assistants. Rutherford Hayner is the program director and announcer.

New Crosley Multistat Has Duo-Winding

When the question of universal filament control comes up, it can be best answered with a Crosley Multistat. This new piece of apparatus is constructed with a low and high resistance wire so as to take care of any of the vacuum tubes, especially the new ones, which make use of the dry-cell batteries for lighting the filament. There is a molded case outside of the winding which keeps the wires in perfect contact with the rotary switch with its ball-bearing contact. This new Multistat has a resistance of from 0 to 20 ohms and sells for 80c.

Practical Hints on Designing of Regenerative Receivers

PART 4—AN IMPROVED SINGLE CIRCUIT REGENERATIVE

By PAUL A. PERRY

THE single circuit regenerative is, without doubt, the most popular as well as the best all-around broadcast receiver of the regenerative type in use. Its long wavelength range with simplicity of control is a combination of which no other circuit can boast. When properly built and used, it will equal or better any other single tube circuit in operation.

However, like every other radio circuit, it has its limitations. The outstanding objection being its inability to separate stations operating on nearly the same wavelengths.

This objection has been partially overcome with the allotment of new transmitting wavelengths. Yet there are many times when distant stations cannot be enjoyed by its being unable to select only one of them. Because of this shortcoming, many modifications of the circuit have been tried in order to give it greater selectivity without losing any of its simplicity of control. There are several modified circuits that have, to a certain extent, accomplished this object, but the one which is most outstanding in its ability is the circuit shown in Figure 1.

A Combination Circuit

As will be noted, this particular circuit may be termed as a direct combination of the single circuit regenerative with the ultra-audion. The direct coupling of the antenna to the plate, controlled by the "plate" variometer, closely resembles the ultra-audion, while the antenna inductance, with its tickler-feed-back coil in the plate circuit, is identical with the single circuit regenerative. This combination makes possible the tun-

ing of the plate circuit and, at the same time, gives the operator the choice of two different methods of obtaining regeneration.

Usually, in the single circuit regenerative, the grid circuit is tuned to the incoming wave while the plate circuit is left untuned. The object being to simplify the controls and to lessen their number. Since the plate circuit is untuned, the detector responds equally well to all signals. Accordingly, if the grid tuning is unable to eliminate a signal, or to separate stations operating on nearly the same wavelength, the only signals and practical method of improvement is by tuning the plate circuit. This is the method embodied in this improved single circuit regenerative.

Since the tickler-feed-back ac-

tion is the same as in the ordinary single circuit regenerative, the best results can only be obtained when the antenna-tickler coil construction is the same as that used in an efficient single circuit regenerative. To secure the maximum induced current from the tickler coil into the antenna inductance, both coils must always be in the same plane and as close as practicable. As the tickler adjustment is usually by a rotary motion, it is of a spherical shape in order to be as close as possible to the antenna inductance as it revolves.

Construction of Tickler

If the tickler coil were spherical and the antenna inductance cylindrical, there would be positions when the tickler coil, as it rotated, would move out of the plane of the antenna inductance.

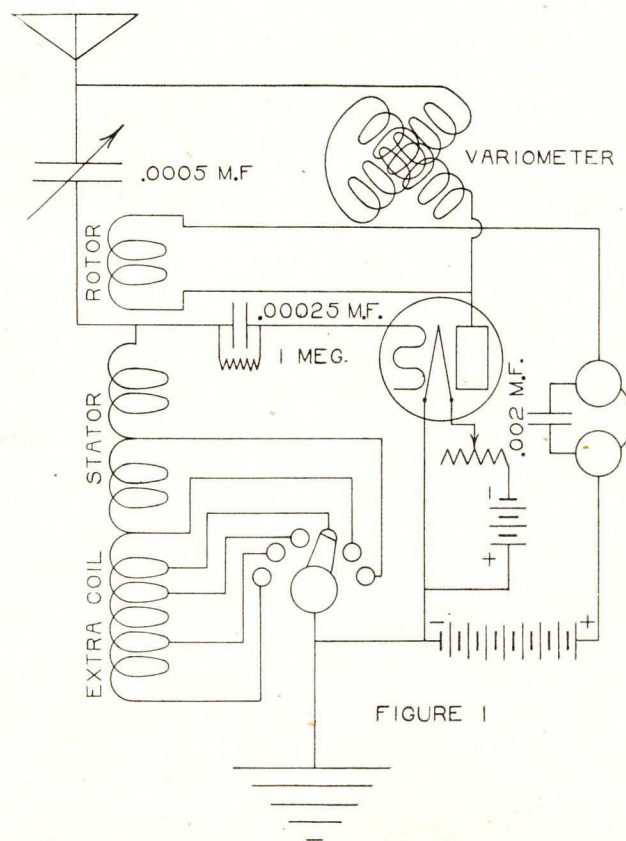

FIGURE 1

These positions would occur as the tickler coil approached an angle of 45 degrees with the antenna inductance. At these positions, the inducted current from the tickler coil into the antenna inductance drops off very materially and the adjustment of the tickler coil becomes very critical. In order that the regeneration controlled by the tickler coil will regularly increase from minimum to maximum without any critical positions, it is necessary that both it and at least that part of the antenna inductance in which it revolves, be spherical in shape.

In constructing this type of set, special attention is called to the winding of the tickler coil. The wire used should be fairly heavy in order to cut down the radio-frequency resistance of the coil and also to broaden its effective field. Number 18 wire is about right as it has a fairly large cross section area and takes up but little space. Only about 40 turns are required. Finer sizes of wire and a greater number of turns have a tendency to choke back the needed radio-frequency currents generated in the plate circuit.

The easiest, as well as the best, method of fulfilling all these requirements is to obtain a variometer that was intended to be used in the plate circuit of a double circuit regenerative set. Be sure to obtain one that is wound with no finer wire than number 20 and has no more than 40 turns on the rotor. The best for this use are wound with number 18 single or double cotton covered wire.

This variometer is then remod-

eled so that the rotor windings are not connected with those of the stator. The two rotor leads are then connected in the plate circuit, as shown in Fig. 1, making the stator windings act as part of the antenna inductance. However, the inductance value of the stator windings is very low and must be built up by the addition of an extra coil placed in inductive relation with the stator coils as shown in Fig. 2. The diameter of this extra coil should

Wavelength Range in Meters.	Total No. Turns No. 20 D. C. C.	Coil Length.	Tap Numbers.	Turns Per Tap.
180-260	20	1/2 Stator	1	20
180-370	40	Whole Stator	2	20
180-500	60	3"	3	20
180-800	150	5 1/2"	4, 5, 6	30
180-1000	250	5 1/2"*	7, 8	50
180-1500	350	5 1/2"#	9, 10	50

be the average between the inside and outside diameters of the stator coil it is placed next to. The winding of this extra coil must be such that when it is placed next to the stator, its winding, together with those of the stator, will be as one continuous coil. If the stator windings are in opposition with that of the extra coil, the set will function very poorly, if at all. The remodeled variometer is used only to give the necessary spherical shape to the antenna inductance.

Assembling the Set

For the best operation, the extra coil should be wound with number 20 D. C. C. wire, the amount depending upon the wavelength required, the size of the variable condenser, and the size of the antenna. In winding the extra coil, room should be left at the beginning for the fastening of the brackets which hold it to the variometer. Taps, to vary the inductance of the coil, are taken off the winding according to the above table.

When the antenna inductance

is finally assembled to be connected, the taps should be arranged in the following order: First, one-half the stator winding; second, the whole stator winding; third, the first tap of the extra coil, and continuing in this manner until the whole coil is used up.

The following table is an approximate winding data, based upon an average antenna with a .0005 mfd., variable condenser, usually used, in series in the antenna lead. The number of turns given includes those of the stator windings:

*When 250 turns are used, it will be necessary to make a double bank winding to get them into the allotted space.

#When 350 turns are used, it will be necessary to make a triple bank winding to get them into the allotted space.

The bank windings are used to keep the inductance of the extra coil as close as possible to the inductance of the stator windings and also to cut down the space required for this unit in the cabinet.

The variometer which is connected between the antenna and the plate is also wound with number 18 wire and has the same specifications as the one which was remodeled and used as part of the antenna coil. Of course, this variometer is not changed, but connected just as it is as shown in Fig. 1. In fact, this variometer may be added to any single circuit regenerative set, which may have been previously built, without the necessity of rewiring the set or the destruction of any of its units.

Like the double circuit regenerative, care must be taken to have the units well placed in the cabinet to avoid any interference between the "plate" variometer and the antenna coil. Such an interference will later result in serious tuning troubles. A good method of construction is to place the variable condenser between these two units, thus keeping them at least six inches apart and avoiding a chaos of future tuning.

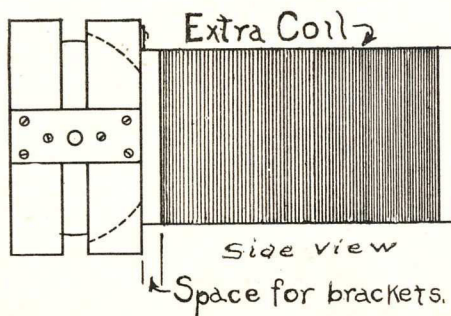
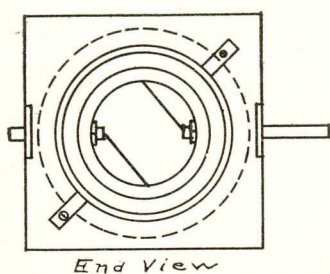

Figure 2

War on Static — Scott's Clariphone

NOVEL INVENTION OF CHIEF ELECTRICIAN OF U. S. NAVY TO SUBDUE MECHANICAL SOUNDS VIA RADIO

ACCORDING to advices from Washington, D. C., the Scott clariphone will prove a great boon to radio. Navy experts declare by means of this device much of the static interference and mechanical sounds will be eliminated or subdued and uniformly pitched sounds only will be received.

The device is the invention of William J. Scott, chief engineer, U. S. N., who has been working on it for the past ten years. Successful tests have been made with the clariphone by the Bureau of Standards and the Naval Radio Central Station, Washington, and now naval officials have published certain facts regarding the unique device in the interest of those fighting summer static and trying to obtain perfect radio communication.

"The entire elimination of static may be hoped for in the near future," one naval officer said, "through the use of some such device as the clariphone."

While experimenting with the Scott clariphone, NPG, San Francisco, was picked up, and was heard faintly through bad static. By changing from the telephone head set on the regular receiving apparatus to a pair of head phones connected with the Clariphone, a remarkable improvement was at once noted; the static was reduced materially and the distant signals from San Francisco came in clearer and sharper. Dispatches from the Naval Stations NBA, Balboa, and NPL, San Diego, were read with ease when the Clariphone was connected in, whereas the dots and dashes were difficult to distinguish through the phones directly on the receiving set.

* * *

The apparatus consists of a large metallic chamber or tube about four feet long and 18 inches in diameter, with adjustable ends. From the chamber eight smaller tubes or "telescopes" project ra-

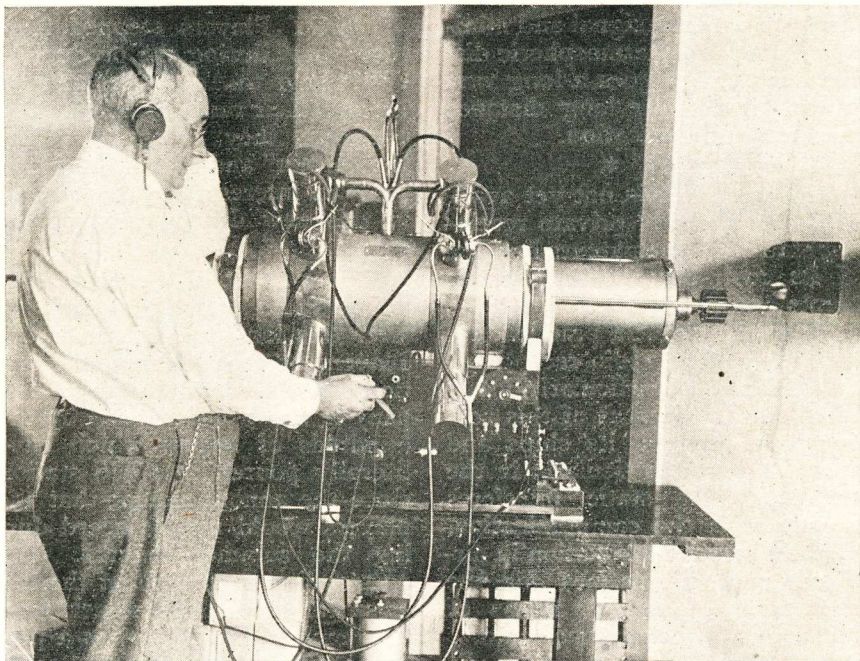

MACHINE ELIMINATES STATIC

W. J. Scott, the inventor, and his "clearphone," a new navy invention, designed to eliminate the static in the air. The new instrument is being tested for adoption by the Navy Department. (Photo by International Newsreel.)

dially in pairs. Each "telescope" contains a watch-case telephone receiver used for introducing the radio signals received from the radio set into the receiving chamber. The incoming sound is then passed through the chamber acoustically, where it is broken up several hundred times, the inventor explains, by the internal arrangement. All of the static is absorbed by over 10,000 separate pieces used in its construction. Exactly how is not divulged. To a lesser degree, the sound waves themselves are also absorbed in the filtering process. A weaker, but a clear note is picked up by four microphones, two on the top of the cylinder and one on each end. The microphones are connected in parallel to the primary of a transformer, the secondary being connected to a head set where the operator receives the outcoming signals after the static is eliminated. The sound of the signals may also be heard through two acoustical phones also attached to the top of the apparatus. When the outcoming sounds are

found too weak, they may be amplified in the usual manner.

Whatever the internal acoustical mechanism may be, the Patent Office recognizes it as a pioneer invention, and Mr. Scott has patents pending in the United States and several foreign countries. The Clariphone will operate for the elimination of static either in radio telegraphic or telephonic communication. Mr. Scott also hopes to be able to eliminate all interference from nearby stations using wavelengths which are close to the wavelength that the instrument is tuned to. To date only one instrument is in operation, but another with some improvements is under construction, it is understood. The inventor is now engaged in working out a practical method for producing a good audible tone to the sound waves which leave the four microphones mounted on the cylindrical chamber and are heard in the head phones by the operator. Many naval experts who have examined and tested the Clariphone, Mr. Scott says, have made helpful

suggestions. Chief Gunner J. J. Delaney, and Chief Radiomen John Gilmore, E. H. Wilkinson and E. L. Cash are aiding Mr. Scott in perfecting the radio end of his invention. With improvements now under way, the apparatus can be tuned to maximum strength wireless signal and minimum strength of atmospheric disturbance, which goes a long way toward improving long distance wireless communication.

* * *

The apparatus is not yet available to owners of private receiving stations nor amateurs because of its cost, but future developments and production on a large scale may make it a practical adjunct to general radio reception.

The Navy is particularly interested since apparatus of this sort could be used on its ships and shore stations, particularly in the tropics, where static interferes greatly with the communication. Lighter sets for adaptation in airplanes and submarines for the elimination of various forms of noise are also being considered.

Hobo Carries Own Receiver

RADIO has invaded the twilight camps of the hobo. Between the dusk and daylight as these adventurers of the road and open spaces gather around the fire watching the brewing tea, they may now hear bedtime stories, stock reports, weather forecasts, not to mention music and drama.

A correspondent of Station WGY, Schenectady, N. Y., who signs himself "A Wanderer for Twenty Years," describes himself as a hobo and says that he always carries some sort of a receiving set with him. He has listened to WGY in Rochester, Binghamton, Buffalo, Glens Falls and Philadelphia, Pa., and admits that no other station has given him any more pleasure.

"I have been to hell and back in my young life," he explains, "and have associated with business men, millionaires, common folks and crooks of all descriptions."

In his concluding paragraph the wanderer writes: "That last Sunday sermon entered through my set into a bootleg joint and I'm sure it done some good."

Radio Players Win Recognition from Countless Fans

IN concluding a season's run of forty-three performances the WGY Players stepped from their parts during the production of "It Pays to Advertise" and addressed their radio listeners. Figuratively they "stepped before the curtain" and told of the pleasure and interest they had found in this new development of the drama.

If any doubt of the popularity of the radio drama had lingered after this long run by the WGY Players at the Schenectady station of the General Electric Company it was brushed aside by the hundreds of letters which have literally poured into the station since the announcement that the players would not be heard during the summer months. The outstanding sentiment of the letters was that the listener feels that each of the players is a personal friend. Practically the same cast has been maintained during the long run, and these same voices coming into a home week after week have won recognition for the players and a place in the hearts of the listeners. Each radio fan, sitting at his set, feels that a production is something put on just for him, and the curtain speeches of the actors helped to cement that feeling of friendliness which exists between performer and listener, no matter how many miles might stretch between them.

A York, Pa., correspondent remonstrates at the discontinuance of the drama as follows: "I would like to know why they (the Players) quit now. In a theater, of course, it is too hot at this time of the year, but not where I go—my radio set. I take a seat way up front and nobody interrupts me changing seats, no women's hats get in the way, no music or candy hawkers interfere with my enjoyment; there are no long intermissions, and you don't even have to dress."

"It seemed like parting with intimate friends and we shall miss you," wrote a radio fan living at East Greenbush, N. Y. "We are glad it will not be long and we shall be anxiously wait-

ing to hear your pleasant voices again in the fall."

Since the initial performance of the WGY Players, "The Wolf," the organization has remained practically the same. Six players who have appeared during the entire season have been Viola Karwowska, Ida Myrick, Ruth Schilling, Edward E. Schilling, Frank Oliver and Edward H. Smith, director. These are the same players who addressed the radio audience.

These pioneers in the radio drama suffered at first, felt handicapped at first, in their efforts to find inspiration from a microphone in a quiet studio. The audience was unseen, and it is rather difficult to find inspiration in something silent and unseen. Then the letters began to come in, and these letters established contact between performer and listener. The actor began to feel that he was addressing old friends who were tolerant of weaknesses in a production and enthusiastic when a situation in a plot was put over successfully.

The Farmer Knew

A PARTY of city dwellers, returning from an automobile trip into the Adirondacks the evening of July 4, began to discuss the Shelby financial fiasco. It was after 8 o'clock and they were naturally curious about the outcome of the fight. Passing a farm house one of the men in the party saw a radio antenna running from dwelling to barn and he suggested that they ask the farmer for the latest news on the fight.

The farmer was caught as he came in from the barn. He calmly heard their question as though it was the most natural thing in the world that he should be asked the outcome of a fight in Shelby, Mont.

"Dempsey won on points," the farmer laconically answered.

The radio story of the fight, broadcast by WGY at Schenectady, N. Y., gave the farmer the news as quickly as it arrived in the offices of great metropolitan newspapers.

Ten Helpful Hints

HERE are ten good rules for broadcast listeners:

1. Don't try to hear Australia in midsummer. Be satisfied to enjoy the nearer stations most of the time.

2. Don't be disappointed if an occasional storm interferes with your summer radio evening. There are many fine concerts coming. You can't expect to find a pearl in every oyster nor to receive a record-breaking concert every night.

3. If you want louder signals, use a longer aerial, more tubes, higher plate voltage, more sensitive loud speakers and more careful tickler and receiver adjustment.

4. A pleasant signal filling a moderate size room should be enough to give satisfaction. It is not worth while producing signals which deafen the neighbors. It is wasteful to insist on tremendous signals, which are generally less pleasant than moderate signals.

5. If your local station comes in too loudly and drowns others out, a smaller aerial will help in tuning him out, with a smaller condenser connected between aerial and ground. And if all measures to get rid of the local station fail, why not enjoy his concerts? He is working hard for you, and it is nobody's fault that you are so close to him that you are bound to hear him. Broadcast stations have to be closer to some people than to others.

6. For the new longer waves above 450 meters, use a condenser connected between the aerial and ground terminals of your set.

7. A little patience in learning to handle your receiver yields rich returns in satisfaction from fine signals. Remember that "Rome wasn't built in a day" and keep on getting more and more familiar with your set and how it works.

8. It is a good idea to read the radio columns of newspapers or the radio magazines. It helps you to know how your set works and keeps you up to date in radio. Information of this sort is an aid in getting the concerts loud and clear.

9. Ask your radio dealer for advice; he can probably tell you what you want to know and will be glad to do so. The manufacturer of your set is also willing to help you get the desired results from its use.

10. Do not throw away the direction sheets or booklet that came with your set and with the tubes. Read all such material carefully now and then. If you have lost the direction sheets, write to the dealer or manufacturer for another. The direction sheets must answer most of the questions which have been puzzling you and preventing you from getting the best out of your set.

Missing Man Found Through Radio

THE value of the radio broadcasting station in its relation to locating missing persons and articles was fully demonstrated when WLW of the Crosley Manufacturing Company, Cincinnati, located Herbert Weber within a day after his description had been sent into the air. This marks the first recovery of a person by radio although thousands of messages and descriptions have been sent to all parts of the world by radio.

Immediately after the church services by radio, WLW broadcast a description of Herbert Weber, a deaf and dumb man whose wife had not been able to locate him. He had wandered off and so the wife turned to the new agency, radio, to help her in her search. She gave a full description of him and then trusted to the modern miracle to do the rest.

T. Paul Jordan of Newtonville, Ohio, a radio listener to the church services, heard the message of distress and began a search for the missing man. It was not until the next afternoon that the deaf and dumb man was found wandering along a country road. Mr. Jordan approached him and wrote on a paper the message he had heard on his radio receiving set. The man wrote back that he was the missing one and then was notified and within a short time he was safely home and the family was most grateful for the services from WLW.



Charles Murray, the comedian of voice over the radio. The radio plays an important part in one of the forthcoming W. W. Hodkinson Corporation comedies.

Radio Replaces Flowers in Hospitals

IN the old days, when you went to see a hospital patient, you brought him food in the dull-witted notion that hospitals neglected the culinary niceties, and it was your duty to smuggle in something that the sick person would enjoy. You knew he would, because you were bringing him his favorite dish, and you never could understand that smarty nurse's edict that he couldn't have it now.

Or you went to the florist and tried to choose between roses tied with a ribbon and carnations gracefully arranged in a basket. And you were always amazed to find that someone else had thought of the same thing, only with more success.

Now, all you have to do to be a little different is to get there first with a radio outfit, and that will soon cease to be a mark of particular attention to your sick friend unless you haul up the latest in tube sets which will "get" the Fiji Islands or wherever it is that the most remote station happens to be.

"Sometimes we have as many as 20 sets in the hospital at once," said Miss Louise Arnold, superintendent of Ellis Hospital, in Schenectady, N. Y. "Many are of the crystal type that will catch WGY only. However, as the sick are rarely here long enough to need the greater diversion that might come from being able to listen in throughout the country, they are a great help in passing time. As soon as convalescence begins, radio can be enjoyed."

Some hospitals use it in treating their patients. New York institutions report success in rheumatism and other chronic afflictions where the ether waves are made to act as a sedative. Doctors there say it has cut down the administration of drugs, because in listening to music by radio, the sufferer is made to forget his condition. Others who are in great pain find the programs an ally in stifling the complaints that are forced when the mind has nothing but pain to dwell upon.



of ILLINOIS
SUMMIT, ILLINOIS

May 26, 1923.

Radio Topics,
1112 No. Blvd.
Oak Park, Ill.

Gentlemen:

Analyzing the quality of inquiries received ever since we have advertised in RADIO TOPICS, it has been proved conclusively that fifty-five per cent of the inquiries are from fruitful sources.

You will continue having our advertising, knowing well the value of a good "National Radio Monthly" and without fear of any "summer slump", with everybody striving to make this a RADIO SUMMER.

Sincerely yours,

DX RADIO COMPANY OF ILLINOIS

Edward H. Spadoni

EFS:FA

DEPENDABLE QUALITY

New and Novel Radio Patents

AUDIOFREQUENCY COUPLING TRANSFORMER

(Patent No. 1,457,619, issued to Saml. Cohen, Brooklyn, N. Y., under date of June 5, 1923.)

The main object of this invention is to provide an efficient audio-frequency transformer of superior utility and applicability to transformers similarly used in radio electrical arts. The essential points in obtaining an efficient audio-frequency coupling transformer are, briefly, the following: The ratio of the reactance to the resistance should be a maximum; the ratio of number of turns in the primary winding to the number of turns in the secondary winding should be a maximum; the degree of coupling between the primary and secondary windings should be a maximum; the leakage reactance of the core and windings should be a minimum; no external magnetic field should exist when the transformer is in operation in order to prevent stray fields from producing coupling between transformers and neighboring electrical apparatus and thereby preventing the generation of electromotive forces of audio-frequency; the coupling transformer in toto should have minimum physical dimensions.

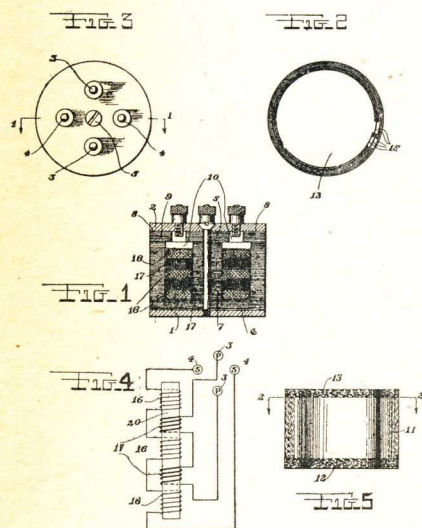

Audio-Frequency Coupling Transformer

Referring briefly to the accompanying drawings, Fig. 1 is a central longitudinal cross-sectional view in elevation of this transformer, taken on the line 1—1 of Fig. 3.

Fig. 2 is a view taken on the line 2—2 of Fig. 5, illustrating a modified form of core, enlarged.

Fig. 3 is a plan view of this transformer. Fig. 4 is an electrical wiring diagram of this transformer.

Fig. 5 is an elevational view of the aforementioned modified form of core, enlarged.

Referring now in detail to the drawings, the numeral 1 represents the base of this transformer, being composed of suitable insulating material. The top member 2, composed of similar material, is provided with a central passage adapted to receive the screw 5, and with four equidistant additional passages adapted to receive the primary and secondary binding posts 3 and 4, respectively.

Upon the base 1 lies the lower core member 6 composed of a number of disks of soft sheet iron, and concentric with said member 6, and resting thereon, is the central core member 7, also composed of sheet iron disks. An outer core member 8, composed of a number of flat ring-like parts, or laminations, rests upon the lower member 6, leaving an annular space concentric with the member 7 between said member 7 and the outer member 8. In this space are placed the windings, after the fashion shown, there being two pri-

mary coils 17 and three secondary coils 16, alternately mounted upon the lower core member 6. The upper core member 9 is similarly composed of a number of sheet iron disks, resting upon the outer member 8 and the central member 7, and being provided with four passages for the binding posts 3 and 4, as well as an additional passage for the screw 5. This screw 5 passes also through the central member 7 and the base member 6, binding the entire device into a compact, rigid unit.

It is apparent that the arrangement of the coils as shown will assure good coupling; the core enclosing the entire device will practically nullify the effect of stray fields; the laminations as arranged will minimize eddy currents.

The wiring diagram of Fig. 4 indicates the manner of connecting the coils, the entire core being represented by the numeral 20.

ELECTRIC DISCHARGE DEVICE

(Patent No. 1,456,505, issued to Wm. A. Knopp, Brooklyn, N. Y., and Paul P. Cioffi, of New York City, under date of May 29, 1923.)

The invention relates to electric discharge devices and a method of manufacturing the same. It has for an object the provision of an electric discharge device in which the need for a glass support for the electrodes in the form of a cane or arbor is eliminated.

The invention in general comprises a plurality of electrodes which are mounted on a rigid wire frame which is connected to the usual press or squash and are by means of the arrangement of the frame rigidly spaced thereon from each other and the walls of the tube.

While in the preferred form of our invention, rigid wires are used as frame members, nevertheless a rigid frame providing the same degree of compactness and rigidity may be provided by the use of glass or other members in place of the wire members.

The invention is illustrated in the drawing which represents in a part elevation, a part section view, a preferred form of tube embodying our invention.

The invention as shown in the drawing comprises an evacuated vessel 1 having the usual press or squash 2 sealed in the lower end thereof. A socket of well-known type 3 is attached to the lower end of the evacuated vessel 1 and has terminal plugs 4 attached to its lower end. Four rigid heavy wires 5, 6, 7 and 8 of any suitable material are imbedded in the upper surface of a press 2 and extend vertically in a spaced parallel relation toward the upper end of the evacuated vessel 1. To the wires 5 and 8 at suitable points intermediate their ends is welded a cylindrical anode 9 which has substantially an oval cross-section. This anode is of nickel and is welded to the wires 5 and 8 along its inner surface. A spiral grid 10 of nickel wire is placed within the cylindrical anode 9 and is welded along opposite sides to the wires 6 and 7. The upper end of the wires 5, 6, 7 and 8 are inserted in apertures in a block of lavite 11. The apertures in the block are counter-sunk at both ends and are slightly larger in diameter than the wires inserted therein. A suitable cement 12, preferably of lead borate, is fused into the counter-sinks and around the wires to form a tight joint between the lavite and the nickel wire.

A filament 13, formed of any suitable material but preferably of platinum coated as known in the art with suitable chemicals, comprises two wires disposed in parallel relation, the upper ends 14 of the wires being held in respective ends of a U-shaped yoke member 15. This yoke member 15 is welded at its upper end to a wire 16 which is rigidly imbedded in the lavite block 11 and supports the filament. The lower ends of the filament 13 are connected to lead-in wires 17 which have formed in their length a loop 18. The loop 18 provides means for conducting current to the filament and at the same time, by

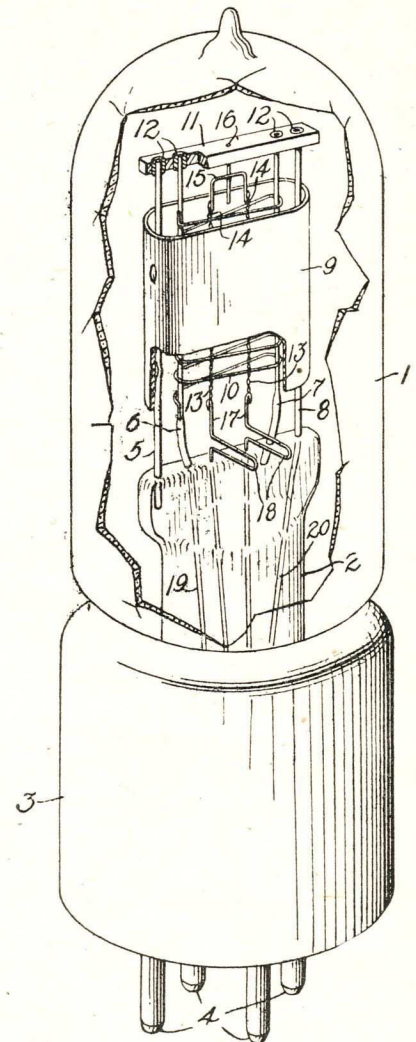

Electric Discharge Device

means of its resiliency, maintains the filament under constant tension and in proper spaced relation. The lead-in wires then extend downwardly through the glass press and are connected to suitable terminals 4. This filament is adapted to carry only .2 of an ampere at a pressure of 2 volts. The wires 6 and 8 are likewise connected respectively to lead-in wires 19 and 20 connected with suitable terminals 4. The rigidity of the wires 5, 6, 7 and 8 and the connection of their upper ends to the lavite block 11 supports the electrodes as a unit which is rigid, and the spaced relations of which are constantly maintained.

AN ANTENNA SELECTOR SWITCH

(Patent No. 1,458,466, issued to Alfred Crossley, Washington, D. C., under date of June 12, 1923.)

The object of this invention is to provide a practical selector switch capable of rapid manipulation to connect various combinations of underground, elevated or loop antenna to the receiving apparatus.

Another object of the invention is to provide in an antenna switch construction means for insuring perfect electrical contact of the switch elements.

Figure 1 is a front elevation of the antenna selector switch. Fig. 2 is a cross-section of the switch shown in Fig. 1. Fig. 3 is

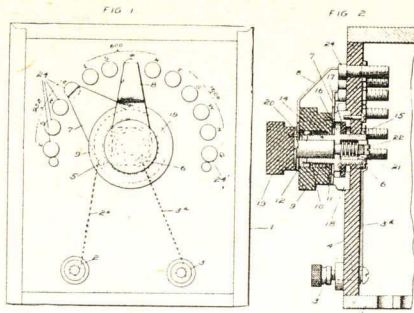

Antenna Selector Switch (Figs. 1 and 2)

schematic wiring diagram of the switch and associated circuits.

Referring particularly to Fig. 1 the selector switch comprises case 1 having binding posts 2 and 3 secured to the top section 4 of insulating material. The binding posts connect to terminals 5 and 6 of rotary switch blades 7 and 8 through 2a and 3a. The rotary switch blade 7 is secured to insulating handle 9 substantially insulated and operative against the thrust of coil springs 10. The coil spring 10 acts between shoulder 11 of handle 9 and screw head 12 of member 14 secured to the inside of top panel 4 by flange 15 and suitable screws for example as shown at 6.

The member 14 is provided with flange 16 adapted to seat against insulated washer 17 recessed in collar 18. The collar 18 is secured to the panel 4 and forms a continuous bearing surface for switch blade 7.

The switch blade 8 is secured to insulated handle 19 having shaft 20 concentric within member 14 and retained in position by means of coil spring 21 and tension screw 22. Screw 6 which is a part of member 14 forms the terminal for switch blade 8 and suitable securing screws connected to collar 18 form the terminal for switch blade 7.

The switch blades 7 and 8 are arranged to rotate concentrically and are free to pass each other over a series of contact points 24. The contacts 24 are so related that the switch blades are capable of contacting with one or two points at the same time. The switch contacts are arranged in groups of four marked as indicated "E, S, W, and N," designating east, south, west and north, and connected as shown in Fig. 3.

In the diagram Fig. 3 I have shown a combination antenna system associated with the

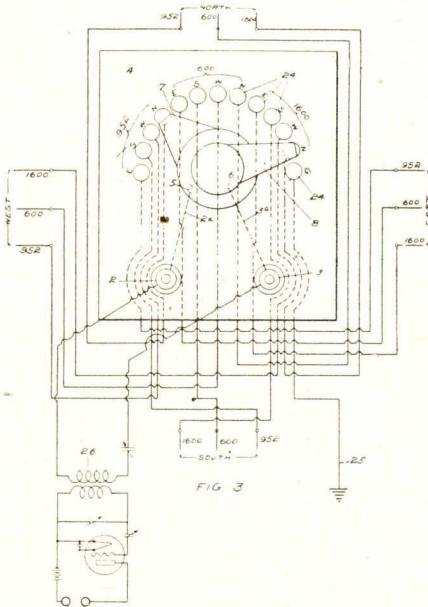

Antenna Selector Switch (Fig. 3)

selector switch at Figs. 1 and 2. The antenna leads from the contact points of the switch are connected to antenna positioned as indicated at the four points of the compass. The antenna proposed in this case are underground cables, but it will be understood that any type of antenna may be connected to the contacts of the switch by use of additional contact points in order to afford a great variety of combinations of antenna with the receiving apparatus. The switch contacts are

designated by groups for the wavelength of 600, 952 and 1,600 meters and the individual contacts marked as previously described with letters showing the points of the compass.

VACUUM TUBE BASE AND RECEPTACLE

(Patent No. 1,458,153, issued to Frank H. Shaw, East Orange, N. J., under date of June 12, 1923.)

This invention relates to bases or receptacles for electrical apparatus, and a general object of the invention is to provide a base or receptacle which will better meet the varied conditions of use to which such structures are now frequently subjected, particularly when utilized in connection with radio telegraph apparatus, or with the electric or radio

VACUUM TUBE BASE AND RECEPTACLE
Filed Aug. 23 1919

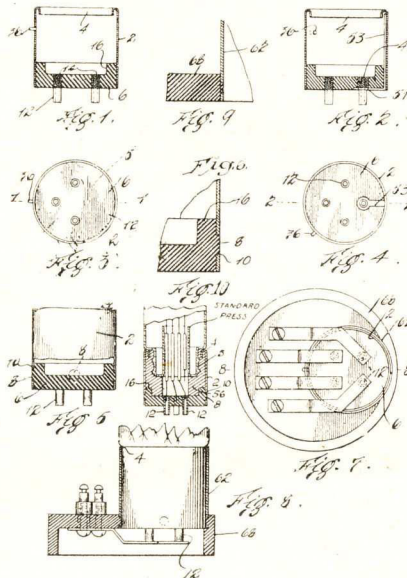

Vacuum Tube Base and Receptacle

equipment of airplanes, with the consequent subjection to marked changes in temperature and in atmospheric conditions.

A particular object of the invention is the production of a base or receptacle having a closure of insulating material molded under pressure into air and moisture proof fit in one end of the metallic shell of which the base is partly formed and also molded into interlocking relation to openings through said shell adjacent to the said end.

Fig. 1 is a sectional view on the line 1-1, Fig. 3, through a base for a vacuum detector tube provided with a four point contact.

Fig. 2 is a sectional view on the line 2-2, Fig. 4, through a base similar to that shown in Fig. 1, but having one of the contacts grounded for use with a tube requiring only a three point contact.

Fig. 3 is a bottom plan view of the base shown in Fig. 1.

Fig. 4 is a bottom plan view of the base shown in Fig. 2.

Fig. 5 is a section on the line 5-5 of Fig. 3, showing the novel interlock between the base shell and the insulating closure.

Fig. 6 is an enlarged detail section showing the novel interlock drawn to a larger scale.

Fig. 7 is a bottom plan view of a receptacle for use with the base of the tube shown in Fig. 1.

Fig. 8 is a section on the line 8-8 of Fig. 7.

Fig. 9 is an enlarged detail of the interlock between the insulating part of the receptacle shown in Fig. 8 and the metallic shell.

Fig. 10 shows the manner in which a base of the type shown in Figs. 1 or 2 is connected to the vacuum tube of a radio detector.

The base, which constitutes the subject-matter of the present invention, is particularly adapted for use with vacuum tubes such as are employed with incandescent lamps and is herein shown in Fig. 10 as employed with a detector tube constituting a part of a radio telegraph outfit of the type commonly employed with airplanes. These incandescent lamp detectors commonly have three or four terminals according to the type of detector

employed and therefore two types of base are provided, that shown in Figs. 1 and 3 having four terminals, and that shown in Figs. 2 and 4 having one of the four terminals grounded so that there are only three effective terminals.

The base comprises essentially a metallic shell 2 having an returned hook-like flange 4 adapted to constitute anchorage for the cement 5 by which the vacuum tube is locked to the base. One end of the shell is closed by a closure of insulating material, preferably material which will stand relatively great variations in temperature and atmospheric conditions—for example, bakelite, condensite, or other phenolic condensation product, and this closure is preferably molded into position under heavy pressure so that it will absolutely fill the open end of the shell and have an air and moisture proof fit in said shell end.

Eliminating the "Boiler Shop"

DID you ever place the receivers on your ears, turn on the "A" and think you had opened the door and slipped into a boiler shop working at 110 per cent? If you are a novice and stick long enough you will—when some one walks across the floor.

The vacuum tube is a sensitive and delicate contrivance, which you well know; otherwise, it wouldn't respond to the infinitesimally small units of energy floating about in space, and unless your tube is so mounted as to decrease the vibration, there are times when you will wonder what's gone wrong.

Mounting your tube or tubes on rubber bands will help a lot to eliminate the "Boiler Shop."

Pieces of old auto inner tube furnish good rubber bands upon which to do the mounting. How-

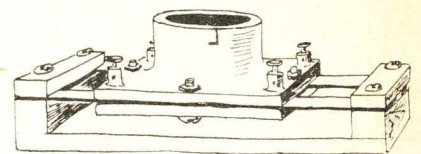

Prevents Tube Howling

ever, if none are available a good stout rubber band 1/2 inch to 3/8 inch in width will answer. Two such rubber bands upon which is suspended the tube socket does the trick.

The illustration serves to show the method of mounting. A small, thin block of wood the same width and length as the base of the socket secured to the base with rubber bands between it and the socket, provide a sling or hammock. The elasticity of the rubber bands permits the socket to set firmly down on the base when inserting the tubes and to swing clear when in ordinary use.

A New Transformer

PREDICTING great enthusiasm for the neutrodyne circuit the WorkRite Manufacturing Company is preparing to meet the demand for parts for that method of receiving by placing on the market a new transformer. This instrument can also be used as a transformer for tuned radio frequency reception or for coupler with condenser across secondary. The WorkRite transformer is said to be exceptionally well made. Tubes of molded Bakelite are used and wound with green silk wire. These are carefully spaced and care has been taken to see that the proper number turns of wire are used to insure maximum efficiency.

To illustrate the accuracy with which these WorkRite transformers are made the following log with dial setting is shown. These stations were all heard on a loud speaker from Cleveland through heavy static:

- 12-12-12 WSAI—Cincinnati, O.
- 14-15-14 KDKA — Pittsburgh, Pa.
- 18-17-17 WEDP—Zion City, Ill.
- 18½-18½-18 WMC—Memphis, Tenn.
- 19½-19-18½ WSY — Birmingham, Ala.
- 20-19½-19 WDAJ — College Point, Ga.
- 20½-21½-21½ WDAP — Chicago.
- 23-23-23 WHAZ — Troy and Schenectady, N. Y.
- 25-25-25 WJAX—Cleveland.
- 25-25½-25½ WHAS — Louisville, Ky.
- 29-28-28 WDAF—Kansas City.
- 35-35-34 WSB—Atlanta, Ga.
- 36-36-35 WOF—Jefferson City, Mo.
- 42-41½-41½ WFAA — Dallas, Texas.
- 45-43-43 WOC—Davenport, Ia.
- 50-50-50 WWJ—Detroit, Mich.

The WorkRite transformer sells for \$2 and should meet with much favor from radio fans.

Pulley in Antenna

Don't fasten your antenna permanently to a bough of a tree if you want it to last. Fasten it by means of a pulley, with a heavy weight at the end, which will keep it taut, yet allow the tree to sway without breaking the wire. —Crosley Radio Weekly.

Radio Amateurs to Race Old Sol

ARACE across the country will take place on the morning of Sunday, September 23, which will rival in speed the late attempts of the flying mail planes from coast to coast. An attempt will be made to beat the sun in its swift daily course across the continent. The transmitters of America's amateur radio fans will be pitted against Old Sol between sunrise and sunset, according to an announcement from F. H. Schnell, traffic manager of the American Radio Relay League, Hartford, Conn.

At least ten picked amateurs on both the Pacific and Atlantic coasts will start messages as the sun comes over the horizon, and they will be relayed by intervening stations. By evening it is expected that most of the messages will have reached their destination, and for the brass pounders the contest with Father Time will end in a radio victory.

These tests have a real scientific value, since they will demonstrate to what extent the sun affects transmission. Everyone fa-

miliar with radio knows that reception over long distances is more difficult during the daytime than in darkness, this being caused, it is believed, by the ionization of the earth's atmosphere by the sun's rays.

The disastrous effect of sunlight upon radio has been noticed by broadcast listeners, as well as amateurs, and it is confidently expected by league officers that definite comparisons may be drawn which will prove helpful in an investigation of this subject.

In this connection some interesting information may be gathered from the experience of Donald H. Mix, league radio operator with the MacMillan exploration party bound for the Arctic, since he must transmit messages and news reports through both daylight and darkness from the Arctic seas to amateurs at home.

"No one will know from what stations the messages will start," says Mr. Schnell, referring to the daylight tests. "Everybody will have the same chance of picking up a message and relaying it along the line." He advises all amateurs to keep a record of everything they hear, and whether they use standard or daylight time. These records should be sent to A. R. R. L. headquarters at Hartford, Conn., by October 1.

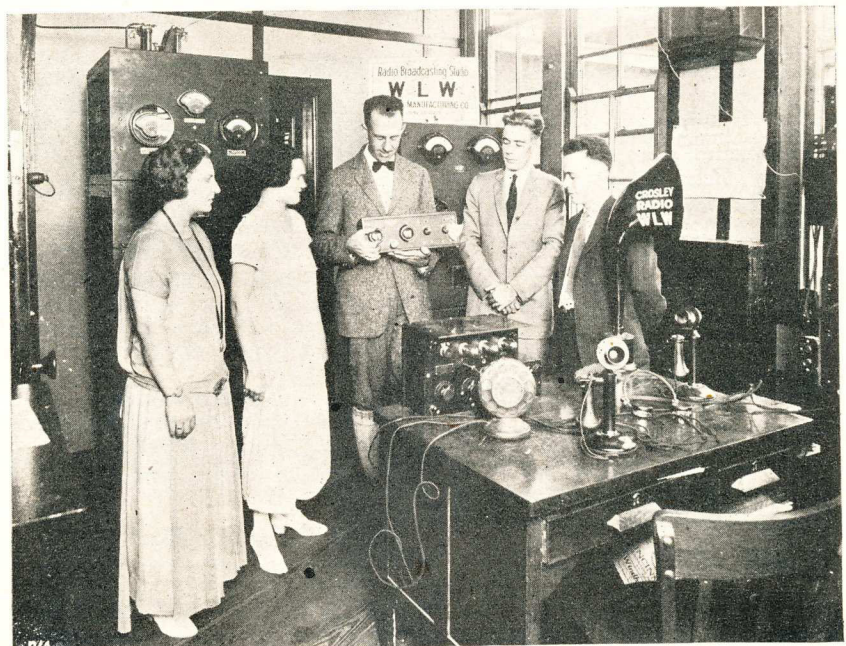

HOLDS A RADIO WEDDING

Two wedding ceremonies were broadcast from station WLW, Cincinnati, August 29 and September 4, Alice Hazenfield marrying William Mains the first week, and Theo Ortney and Vincent DeCamp on September 4. The picture shows Powel Crosley, Jr., chairman of the radio committee of Cincinnati Fall Festival, showing the wedding candidates the apparatus.

Radio's Steady Progress

(Continued from Page 11)

ception. The test signal used by the operator in the two cities was the letter D, a long dash and two shorts, repeated hour after hour at a stretch. This became so tiresome that Mr. Dempster built a motor driven transmitter set for Schenectady and the machine re-

lieved the tedious work of the operators.

The head phones adopted were especially made according to the navy standard and they were wound for the first time with enameled wire. These phones were one twenty-fifth as sensitive as the cheapest head phones on the market today.

Signals Are Now Magnified

In the early days of radio the signal acted directly on the receiving apparatus, whereas today, by means of circuits and B batteries, the signal is magnified from one to 25,000,000 times, the signal acting as a valve to regulate the B battery current.

Back in the old days signals were occasionally received when fifty kilowatts were impressed on the antenna, using 180 foot masts. Today an operator in Lynn, Mass., with a three bulb receiving set can get Schenectady signals 1,000 times stronger than was possible in 1903, and that from a transmitter using but five watts and a mast fifty feet high.

At the same time experiments were being carried on in Schenec-

tady and Lynn, Prof. Fessenden was operating two very high powered stations, using 100 kilowatts with 480 foot steel casts and umbrella antenna. One of these stations was located at Brant Rock, near Plymouth, Mass., and the other was at Machrihanish, Scotland.

Biggest dollar's worth in RADIO

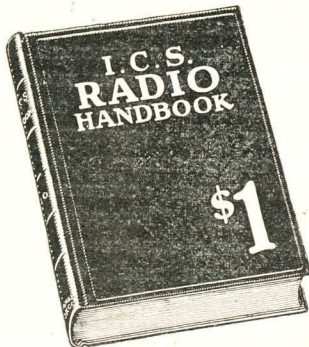

Compiled by HARRY F. DART, B.S.E.E. Formerly with the Western Electric Co., and U. S. Army Instructor of Radio Technically edited by F. H. DOANE

JUST OUT. 562 PAGES

THE most complete book of its kind ever published. Written, compiled and edited by practical radio experts of national reputation. Packed with concise, sound information useful to every radio fan—from beginner to veteran hard-boiled owl. Hundreds of illustrations and diagrams to make every point clear. Note this partial list of contents:

Different types of receiving and sending hook-ups, electrical terms, condensers, oscillating circuits, induction coils, antenna systems, electric batteries, generators and motors, protective devices, crystal detectors, arc generators, transmitters, filters, wavemeters, radio experiments, International and Morse codes, commercial receiving sets, tables and data, radio transmitting and broadcasting stations (with call letters), Radio License Regulations, etc.

Send \$1 to-day and get this 562-page I.C.S. Radio Handbook before you spend another cent on parts. Money back if not satisfied.

Mail the coupon Today

INTERNATIONAL CORRESPONDENCE SCHOOLS

Box 8291, Scranton, Penna.

I enclose One Dollar. Please send me—postpaid—the 562-page I.C.S. Radio Handbook. It is understood that if I am not entirely satisfied I may return this book within five days and you will refund my money.

Name.....

Address.....

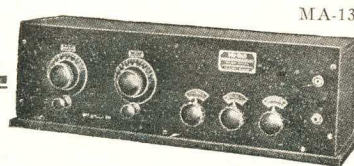

Of Special Interest to Radio Dealers

One of Chicago's oldest and largest exclusive radio stores sold more Mu-Rad Receiving Sets in 1922-23 than all other types of Receivers combined!

Mu-Rad Sells

That fact has been repeatedly verified by our many other Mu-Rad dealers in the middle west. Why not join them? Why not enjoy as they do the assured profits of good radio merchandise well advertised?

Write for a Mu-Rad Franchise

To get complete details of our special Mu-Rad proposition will not obligate you. Write also for a copy of our hand-book catalog of other profitable radio merchandise. Write today before someone else in your neighborhood gets exclusive Mu-Rad privileges.

Chicago Radio Apparatus Co.

Jobbers of Good Radio Merchandise
General Offices: 407 South Dearborn Street
CHICAGO

Perfect Performance

Crosley Model X Gives Better Radio Reception

The popularity of the Crosley Model X is increasing daily. This four-tube set—still priced at \$55—maintains its marvelous record of bringing in distant stations.

A man from Chatham, Va., writes:

"I own a Crosley Model X. I have picked up over 130 stations in the U. S. and have listened to Havana, Canada, North Dakota, all Texas and ships at sea."

You can depend upon an instrument bearing the name Crosley.

For Sale by Best Dealers Everywhere.

Crosley Mfg. Company
923 Alfred St., Cincinnati, O.

Send for Free Catalog

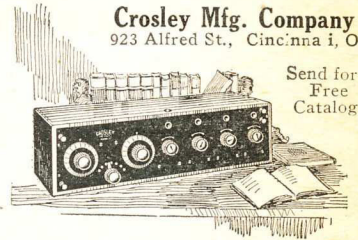

Public Sales

We Have Purchased

122,000 Pair

U. S. ARMY MUNSON LAST SHOES

Sizes 5½ to 12, which was the entire surplus stock of one of the largest U. S. Government shoe contractors.

This shoe is guaranteed one hundred per cent solid leather, color dark tan, bellows tongue, dirt and waterproof. The actual value of this shoe is \$6.00. Owing to this tremendous buy we can offer same to the public at \$2.95.

Send correct size. Pay postman on delivery or send money order. If shoes are not as represented we will cheerfully refund your money promptly upon request.

National Bay State Shoe Company

296 Broadway, New York, N. Y.

Makes Good Ground

The best possible ground is a wire dropped into a well, with a copper or zinc plate at the end of it. If you can't do this, bury a dozen or so old tin cans and attach a wire to each one of them. This makes a good ground if the earth is moist.—Crosley Radio Weekly.

The casualty lists that railroads, street cars and autos are responsible for are charged up to progress. There is not a single death chalked up against radio so far.



Talk Number 6

SIGNAL

Facts from the Factory

Don't let exaggerated stories of summer "static" dampen your enthusiasm for Radio at this season. On most summer nights—especially in dry weather—receiving is as good as at any other time of the year. But you must have quality apparatus—like SIGNAL, for instance.

Most of the interference attributed to static and other air disturbances is due to apparatus incorrectly, ignorantly, or carelessly manufactured. You never—at any season of the year—can get satisfaction with such apparatus.

But with SIGNAL Radio Sets, or parts, it's different. Every SIGNAL item is made in a factory that has grown up with "wireless." Utmost precision marks even the smallest detail of manufacture. With SIGNAL, service is inbuilt. SIGNAL has stood the test of time.

Say SIGNAL, when you're buying radio equipment, and you'll "listen in" with satisfaction the whole year through.

SIGNAL Electric Mfg. Co.

Factory and General Offices
1901 Broadway, Menominee, Mich.

Atlanta Cleveland Pittsburgh
Boston Minneapolis St. Louis
Chicago New York San Francisco
Montreal Philadelphia Toronto

(2423)

INFORMATION COUPON

Signal Electric Mfg. Co.,
1901 Broadway,
Menominee, Mich.

Please send catalog and bulletins, giving complete information about SIGNAL Radio equipment to name and address written in margin—without obligation.

ANNOUNCEMENT

THE GREAT NORTHERN STEAMSHIP COMPANY

(Incorporated)

BOSTON, MASS.

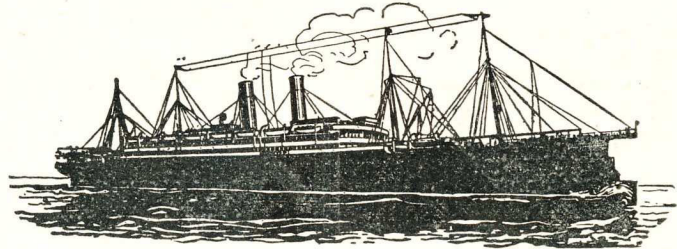

Announces that arrangements are now being made for monthly

\$110 Round Trips to Europe

Boston—Southampton

\$110

ONE WAY \$65

Connecting for

London, Liverpool, LeHavre

Boston—Gothenburg

\$138

ONE WAY \$75

Connecting for

Christiana, Stockholm, Helsingfors, Danzig, Riga, Copenhagen

THE ABOVE PRICES INCLUDE RAILROAD FARES TO POINTS AS FAR NORTH AS STOCKHOLM

The Company plans to carry approximately two thousand passengers monthly. Make your plans now for a trip during the coming season.

Lives of passengers will be protected by **EVER-WARM SAFETY-SUITS** which prevent drowning and protect from exposure

A round trip, with all expenses on ship-board included, at no more expense than a vacation right here at home! To meet the ever increasing demand in this country for an inexpensive and at the same time thoroughly comfortable and enjoyable trans-Atlantic voyage, is the prime object of the Great Northern Steamship Company. Organized by progressive business men who realize the exceptional opportunity offered now for inexpensive travel in Europe, the Company will cater to the thousands of

intelligent persons who wish to visit the battlefields of France, the Shakespeare country, Scandinavia, the Land of the Midnight Sun, etc. A chance of a lifetime! So it would seem; but it is more than that. The Company is building for permanent business, setting a new standard of high-class ocean travel on a one-class basis. That this can be done at a fair margin of profit has already been proved and is further outlined in our prospectus. You'll find it extremely interesting.

WE WILL ALSO SHOW YOU HOW YOU MAY BECOME A PART OWNER IN THE MOST TALKED-OF ENTERPRISE IN YEARS

Cut out and mail us with your name and address

A. Wikstrom
Information Dep't
Edmunds Bldg., Suite 54
Boston, Mass.

I am interested in securing full information regarding a trip to:
(Mark with a cross) One way Round trip
England
France
Germany
Sweden
Norway
Denmark
Baltic Provinces
Finland
Russia

A. Wikstrom
Information Dep't
Edmunds Bldg., Suite 54
Boston, Mass.

I am interested in becoming part owner in the Great Northern Steamship Company.

Please send me proposition and full particulars.

Name
Street or R.f.d.
City or Town
State

Announcing—
A New
Burgess "B" Battery
Vertical Type



"A Laboratory Product"

THE engineers of the Burgess Laboratories have designed a new "B" Battery. When we use the term 'new' we are referring only to the shape, for it is vertical rather than flat as is the case of the standard Burgess "B" Batteries.

It was designed to meet a definite desire and almost an actual necessity arising through the widespread tendency to improve the appearance and convenience of home receiving sets by means of a neater and more compact assembly of equipment.

This new vertical "B" type battery saves half the floor space of the standard "B" battery. Because it stands vertically and is about the same height, it may be combined with a No. 6 Dry Battery if that type is used for the "A" or filament circuit. In the usual style of cabinet this vertical "B" battery may be slipped behind the equipment, leaving the terminals exposed at the top for convenient connections.

The Burgess Battery Company is responsible for many of the vital improvements found in present day batteries, and this new vertical "B" Battery is recommended to you with every confidence that it will please you in every particular — power, silence, long life, convenience and absolute dependability.

BURGESS BATTERY COMPANY
 Engineers—DRY BATTERIES—Manufacturers
 Flashlight—Radio—Ignition—Telephone

General Sales Office: Harris Trust Bldg., Chicago
 Laboratories and Works: Madison, Wis.
 Branches

New York Boston Washington St. Paul Kansas City New Orleans
 In Canada: General Offices and Works, Niagara Falls, Ontario
 Branches: Toronto Montreal Winnipeg St. John
 "Ask Any Radio Engineer"

BURGESS
RADIO BATTERIES

The Receiver
famous thru Performance
Telmaco



Type B-R Receiver

fully meets the requirements of the discriminating purchaser because of the following features:

EFFICIENCY OF OPERATION: Securing volume, distance (1500 miles with single tube is not unusual), selectivity; broadcasting stations one-half mile distant are tuned out by a slight turn of condenser dial.

EASE OF OPERATION enabling the novice to secure satisfactory results.

HIGHEST QUALITY OF WORKMANSHIP AND MATERIALS.

\$25.00 PRICE within the reach of everybody. Manufactured exclusively for us by

Tri-City Radio Electric Supply Co., licensed under Armstrong U. S. Patent No. 1113149, Oct. 6, 1914.

Telmaco BA 2-Stage Amplifier for the Above \$20.00

Our New Radio Guide Book
Sent at Your Request

Our new 64-page Catalog No. TCR contains twenty of the most popular radio circuits printed in blue. These include the Hazeltine Neutrodyne, Grimes Inverted, Colpitts, Flewelling, Reinartz, Diode Electrad, Heterodyne, Super-Regenerative and many others. Each article used in circuit is attractively pictured instead of appearing in straight schematic form. Besides containing blue prints, the best in radio is also illustrated and described. Catalog sent postpaid for ten cents. Each circuit worth double.

Send for your copy today



20 Circuits
in Blue in
Catalog

JOBBERS We have an attractive proposition for a few more bona-fide Jobbers **DEALERS** If your Jobber cannot supply you order direct

TELMACO Radio Division **TELEPHONE MAINTENANCE CO.**
Quality Radio Exclusively 20 So. Wells St., Dept. C, Chicago, Ill.

Crosley Has Largest
Receiving Set

AMERICA likes to have things that are "big," and on the Night Pageant of the Cincinnati Fall Festival, held August 24, there was shown the largest radio receiving set in the world.

This gigantic set is not only decorative, but practical, and was made from the famous Crosley Model XJ. It measures 12 feet

long, 6 feet wide and 5 feet high. A loud-speaking horn, 11 feet long, with an opening of five square feet, sent the highly amplified music from the WLW studio of the Crosley Manufacturing Company.

The first orchestra to play for this initial event was the Elmer Aichele Novelty Dance Orchestra, and the band music was supplied by the little musicians composing the General Protestant Orphanage Home Boys' Band, under the direction of Edward Schacht.

The Cat's Whiskers

By
AUNT ENNA

FULL many a gem of purest ray serene
Has lost its sweetness on the desert air
Because some boob with a big sending set
Has "buted in" where others did not dare.

* * *

A big research worker makes the assertion that every noise made in a room is recorded there in some manner—in the walls or plaster—some-what like a phonograph record. Some-one is always taking the joy out of life. Think of the foolish things you said in your wife's parlor those many years ago when you were courting her. And if she could get a record of it and spring it on the five hundred club when it is at your house some night! Oh, boy!

* * *

Little coils of wire,
Little battery cell,
Make the mighty radio
All its secrets tell.

* * *

The Old Inventor says that if he could figure out some way to connect the North and South Poles with a big copper cable he could get enough electricity to do all the work of the world.

* * *

What makes the Cat's Whiskers bristle with genuine disgust are those fellows who imagine that "radio is only a passing fad." That's what they said about autos not so very long ago.

* * *

There was a man in our town,
Yet he was not so wise;
He tried to run a business
And did not advertise.
But when he found his trade all gone,
With all his might and main
He printed ads most everywhere
And prospered once again.

* * *

Readers—this is your column—and Aunt Enna welcomes any helps, criticisms or contributions you may feel like getting rid of. Don't be bashful.

* * *

If you don't believe radio is popular, just count the aerials along your street. And then multiply that by a few million.

* * *

A sad faced man was William,
His vision was most solemn;
But do not blame the poor, poor man—
He wrote jokes for a column.

* * *

Last lines, like death and taxes, are inevitable, so here's our's—"Cat's Whiskers signing off."

"THE BETTER RADIO" PIERAGICO

The Perasco Kewpie

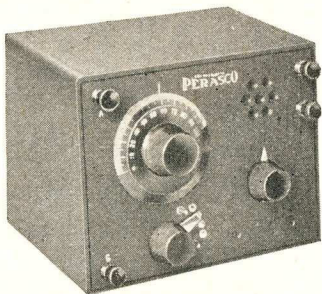

Ideal for vacation or home use. Its special circuit makes possible the reception of stations without an aerial of any description. Any tube may be used with equal efficiency. Range 1,000 miles.

Perasco Kewpie\$25

(Descriptive folder sent on request)
Special Discount to Dealers

PERRY RADIO SUPPLY CO.

218 WASHINGTON BLVD.,
RIVER FOREST, ILL.

a Chi-Rad Special! for W D 11 tubes—

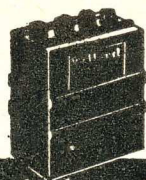

Standard, threaded rubber, Willard's specially adapted for use with W. D. 11 tubes. Supply current at 2 volts to one W. D. 11 tube for 210 hours on a single charge. Rechargeable. Brand new, size 4x5½x7 inches—Chi-Rad guaranteed.

2-Volt Willard Charged.....\$7.50
2-Volt Willard Dry..... 6.50

These same Willards can be adapted to deliver 8 volts for pure D. C. for C. W. Transmitters. Better than a generator because no filter is necessary. Much less expensive.

In lots of 40 (320 volts), \$160.00

(Better prices on larger quantities.)

Specify dry or charged when ordering.

Chicago Radio Apparatus Co.
415 W. Hubbard St., Chicago, Ill.

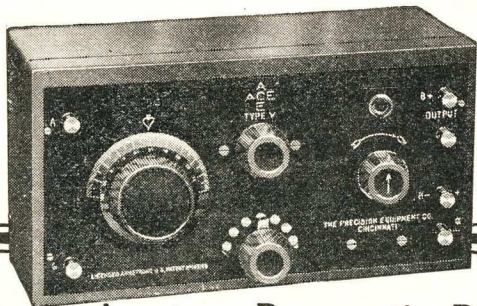

ACE TYPE V

Formerly Called
Crosley
Model V

\$20

Armstrong Regenerative Receiver

Licensed under Armstrong U. S. Patent No. 1,113,149

The low cost of this set together with its efficiency and simplicity makes the great demand for it increase daily. A long range receiver. Stations from coast to coast heard distinctly. An ace two-step amplifier in connection with this set at \$20.00 makes use of loud speaker practical. Has Crosley Multistat which permits use of any make tube. Ask for "Simplicity in Radio"—it's FREE. Dealers, write on your letterhead for splendid sales proposition.

THE PRECISION EQUIPMENT COMPANY

Rose Crosley, Jr., PRES.

923 Vandalia Avenue CINCINNATI, OHIO

SEND NO MONEY



A limited quantity of Standard Make, high grade, fully guaranteed typewriters at lowest price ever offered.

FREE TRIAL

for five days in your own home. Easy monthly payments. No "red tape". Send Today for Free Booklet of Valuable Typewriter Information, also Special Sale Bulletin.

Smith Typewriter Sales Co.,
-360 E. Grand Ave., Chicago, Ill.



Best for Your
Radio
Set

Bring in programs clear and sweet; free from distortion. Highest quality—biggest value. 2000 ohms, \$5; 3000 ohms, \$6.

HERBERT H. FROST, Inc.
154 W. Lake St. • Chicago



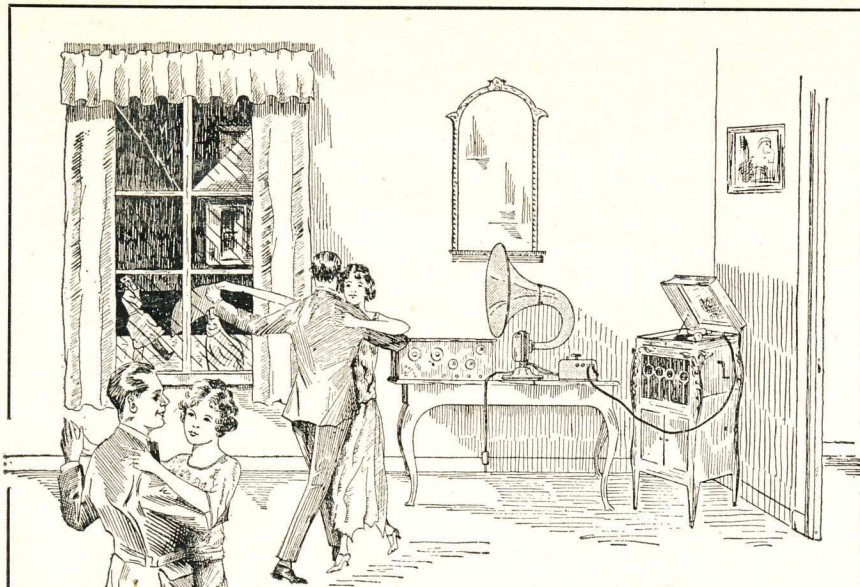

Another Use for Loud Speaker

When the static is too great for radio reception, your **AUDIOPHONE** Loud Speaker can be used with the Bristol Phonograph Record Reproducer on your phonograph. Then you may have concert or dance program without interruption.

Attached instantly without mutilating the instrument in any way—the Bristol Phonograph Record Reproducer can be used with any make of phonograph.

Equipped with such an outfit, there are no disappointments—it is always ready—never fails. For dance music you have the equivalent of an orchestra, but without the expense.

The tone of the phonograph thus amplified through the **AUDIOPHONE** has volume enough to fill large rooms and the quality is round—smooth—and beautiful—entirely free from mechanical noises.

Remember that the same **AUDIOPHONE** Loud Speaker is used in common for both radio reception and phonograph record reproduction.

Write for Bulletin 3007-P and we will advise where you may hear a demonstration.



AUDIOPHONE
TRADE MARK
REG. U. S. PAT. OFFICE

The Bristol Company

WATERBURY, CONN.

BRANCH OFFICES:

Boston
Detroit

New York
Chicago

St. Louis

Pittsburgh

San Francisco

Philadelphia

Washington's New Station

(Continued from Page 18)

frequency currents, but protects the operators from accidentally coming in contact with bare surfaces carrying 2,000 volts.

The operating table is in front of the transmitters and on it is a small box through which the operators may throw in either of the powerful transmitters and listen to the outgoing program at various stages of its progress. On this table, also, is a microphone that the operator on duty may cut in and talk to the "unseen audience" himself should this be necessary at any time. By means of an inter-communicating phone he may talk to office, studio and reception room or be called by them. Because the law requires that a transmitting station must constantly listen-in for distress signals from ships, a highly efficient receiver is provided.

The motor-generators are housed in an adjoining sound-proof room, that their low hum may not disturb either artists or operators. Two machines are provided, one for each transmitter. Each of these powerful units consists of a single motor driving two generators, one of which supplies 2,000 volts for the oscillator and modulator tubes and 1,000 volts for the amplifier tubes, while the other furnishes the 125 volts used to operate the automatic relays and the 88 volts which heat the filaments of the large vacuum tubes.

Oscillograph Installed

A unique feature of this station, and one which further assures perfect transmission of programs, in a device known as the oscillograph, by which the operators have before them "a working picture of the voice." The delicate instrument may be switched into any one of the many circuits and shows, by means of an undulating, ever-varying beam of light, exactly how the artist's voice or music is affecting the electrical and radio currents. By watching this little tell-tale beam, as reflected from revolving mirrors, one knows instantly whether the sound waves are too weak, too great in volume or blurred.



Make Your Set The Sensation of Your Town!
with

The **RADIOXOR**

Simple - Inexpensive - Certain

Can be attached to any set operating head phones or loud speakers, crystal or vacuum tubes, loop, plug or outdoor aerial.

Send your name, address and type of set on a postcard for details.

Selling like wildfire, so act promptly. Orders filled in order of receipt.

Willart Sales Company

Worlds Tower Building

110 West 40th Street

New York City

Railroad Fare

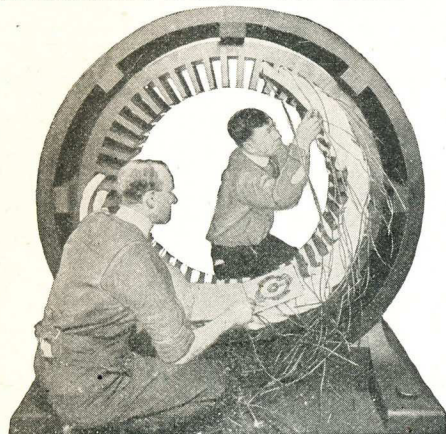

Student Winding a Stator

To the Great Shops of Coyne

We pay your railroad fare to Chicago—the Electrical Center of the World—from any place in the United States. Grasp the opportunity to see the country at our expense. Come to Coyne—learn electricity in 3½ months. Get a complete training so you can make big money as Power Plant Operator, Superintendent, Telephone man, Construction worker, auto, truck or tractor electrician, battery man, radio expert, or you can go into business for yourself as electrical contractor, dealer, auto ignition or battery expert and make from \$3,000 to \$20,000 a year. Hundreds of our graduates today are making big money and you can do the same if you grasp this opportunity—act now.

Learn Electricity In 3½ Months

No books or useless theory. You are trained on \$100,000 worth of electrical equipment. Everything from door bells to power plants. You work on motors, generators, house-wiring, autos, batteries, radio, switch-boards, power plants—everything to make you an expert ready to step right into a position paying from \$45 to \$100 a week.

Radio Course FREE

We include the following free with the regular course; (1) A complete course in auto, truck and tractor electricity and storage batteries. Greatest outlay of auto, electrical and battery equipment in the country. (2) Course in Radio—the marvel of the age. Constructing, installing and operating. You can build your own wireless telephone set. (3) A life scholarship in the Coyne school. You can stay as long as you wish and return for further training at any time in the future.

Earn While You Learn

We help students to secure jobs to earn a good part of their expense while studying.

Send Coupon Now

Don't delay a minute—send that coupon in **right now** for our big free catalog and full particulars of Free Railroad Fare offer. Act now!

B. W. COOKE, President

Coyne Trade and Engineering School
Dept. 5993 1300-1310 W. Harrison St., CHICAGO

B. W. Cooke, Pres. Coyne Trade and Engineering School,
Dept. 5993 1300-1310 W. Harrison St., Chicago, Ill.

Dear Sir: Please send me free your big catalog and full particulars of your special offer of Free Railroad Fare and two extra courses.

Name

Address

Radio Catalogue Free

Write us a post card—

and we will send you free this 52 page catalogue of radio sets and parts. It also contains explanation of radio terms, map and list of broadcasting stations and much radio information, including an explanation of successful hook-ups and circuits.

You will be amazed at the low prices Ward's quote. A complete set for \$32.50 equalling sets at \$60 elsewhere—a \$23.50 set that under favorable conditions has a radius of 500 miles and more.

This catalogue contains everything for the expert and amateur. Complete sets and every improved part for building sets, all the most up-to-date devices—at the lowest possible prices.

Headquarters for Radio

Montgomery Ward & Co. is headquarters for Radio, selling everything direct by mail without the usual "Radio-profits." Why pay higher prices? Ward quality is the best and the prices will often save you one-third. Everything sold under our Fifty Year Old Guarantee,—Your Money Back if You Are Not Satisfied. Write today for your copy of this complete 52-page Radio Book.

Write to the house nearest you. Address Dept. 3-R

Chicago Kansas City St. Paul Portland, Ore. Fort Worth

Montgomery Ward & Co.

—The Oldest Mail Order House is Today the Most Progressive—



Jones Fiddlestick Vernier



Pat. Pend.

Price 10 Cents

Drill a 1/8 in. hole 3-16 in. from edge of each dial. No screws, no nuts, no washers or springs. Keep it in your hand and go from dial to dial. Eliminates all body capacity on fine tuning. Keeps your hand six inches from set. Mounted two dozen on a card for counter display.

Sample sent for twelve cents in stamps.

Howard B. Jones

612 S. Canal St., Chicago

Radio Fans—Write for Our Complete Radio Catalog

Standard Radio Corporation

MANUFACTURERS, DISTRIBUTORS AND JOBBERS

227-229 West Madison Street CHICAGO

PATENTS

To the Man with an Idea

I offer a comprehensive, experienced, efficient service for his prompt, legal protection and the development of his proposition.

Send sketch of model and description, for advice as to cost, search through prior United States patents, etc. Preliminary advice gladly furnished without charge.

My experience and familiarity with various arts frequently enable me to accurately advise clients as to probable patentability before they go to any expense.

Booklet of valuable information and form for properly disclosing your idea free on request. Write today.

RICHARD B. OWEN, Patent Lawyer
81 Owen Bldg., Washington, D. C.
2278-M Woolworth Bldg., N.Y. City

AT LAST!

An Attractive and Conservative Deferred Payment Plan

For the Purchase of

Radio Apparatus

Is Made Available to Every Responsible
Person

The IODAR PLAN makes possible the purchase of ANY piece of ANY make of Radio Apparatus; Sets, Parts and Raw Materials, on a very attractive plan, requiring only 25% of the price with the order, with 6 months in which to pay the balance. Deliveries are prompt, in most cases shipment being made within a few hours after receipt of order. Full details will be sent on request without obligation, or send 25c in stamps or coin and receive the IODAR SERVICE BULLETIN each month, together with full details of the IODAR PLAN.

DO IT NOW!

Dept. 50

Iodar Sales Company

(Not Inc.)

OAK PARK

114 S. Oak Park Av.

ILLINOIS

25^c Trouble With Your Set?

Ever think how important the Grid Circuit is?

Mica insulation, wax treated Grid Condenser. Can be used as bi-pass condenser on amplifying transformers, etc.

POSTPAID

DEALERS—ATTRACTIVE PROPOSITION



DEPT. S

OF ILLINOIS

SUMMIT, ILL.

WHEN YOU BUILD A SET

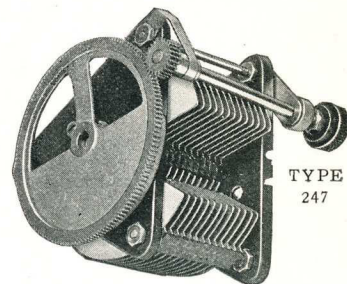

TYPE 247

Here are the Essentials—

1. A quality Condenser—type 247—fitted with reduction gearing for fine capacity adjustment.

2. A Rheostat (or Potentiometer)—type 301—designed especially for UV-199 and 201A tubes.

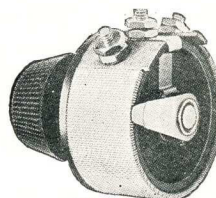

TYPE 301

3. A UV-199 Tube Socket, ruggedly built of molded Bakelite, with phosphor bronze springs.

4. And the well-known General Radio Co. Amplifying Transformer, giving maximum amplification without distortion.

All of these are guaranteed by the General Radio Company.

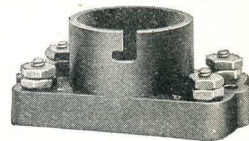

TYPE 299

For dependability and results build your set around these essentials.

Ask for Bulletin 916T. It contains our complete line of receiving equipment.

General Radio Co.

Manufacturers of Electrical and Radio Laboratory Apparatus

Massachusetts Ave. and Windsor St. Cambridge, Mass.

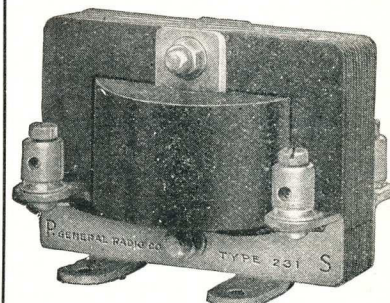

TYPE 231

5568

May We Give You Any of These?—

It won't cost you a cent to get any of these things. Just secure a few subscriptions to Radio Topics and they are yours

You, as a reader of RADIO TOPICS, know that you, as well as your friends, should be regular subscribers. Sign them up and get whatever you wish.

A well built variocoupler, complete with dial, which sells for \$6.50, will be mailed to you postpaid for 3 one-year subscriptions.

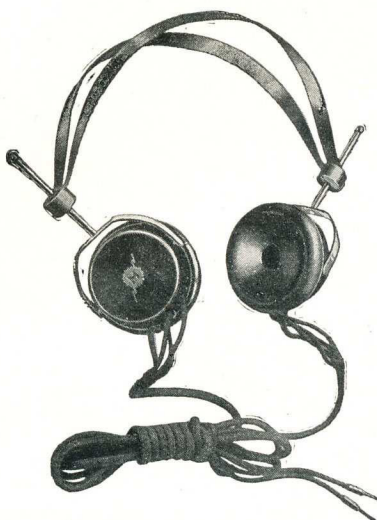

Manhattan 2,000 ohm phones sell for \$6.00. You may have a pair postpaid for 3 one-year subscriptions at \$2.00; total \$6.00.

A variometer, complete with dial, is also yours for 3 one-year subscriptions to RADIO TOPICS.

You may also have a full set, consisting of a variocoupler and two variometers, with dials, whose value is about \$18.00, for only 8 one-year subscriptions.

Just send us subscriptions, either renewals, new ones or your own, whose total at our rate of \$2.00 per year equals the price of the item you want, and we'll send it immediately prepaid.

All of the items listed on this page are fully guaranteed.

If there is something you want not listed, we'll arrange to get it.

A WorkRite splendid loudspeaker made of a composition and having a receiver in the base with extension cord. It costs \$12.00, and is yours for 6 one-year subscriptions.

Address: RADIO TOPICS

CIRCULATION MANAGER

1116 NORTH BLVD.

OAK PARK, ILL.

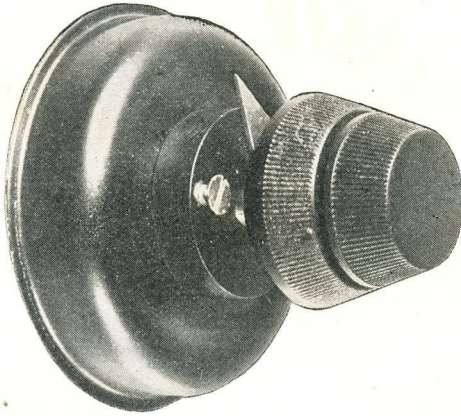

As Noiseless and Smooth as a Bird Thru the Air

- ☐ Gone are the scratching and noises as you vary the current to your tubes.
- ☐ No need to turn back the rheostat to shut off the tube; just a touch of the fingers and a bearing switch throws it in or out.
- ☐ Can you imagine anything more perfect and smooth in operation than a resistance wire passing through a well of mercury?
- ☐ There is also a Gollos Potentiometer on the same principle.
- ☐ Then there is another wire which gives a vernier adjustment.
- ☐ They come ready for panel mounting and template furnished. A Gollos Mercury Rheostat sent postpaid for only.....\$2.00

Dealers Desired

GOLLOS DEVICES, Not Inc.

"Perfect Noiseless Rheostats"

118 N. La Salle Street :: CHICAGO

Suite 704

The Gollos Mercury Rheostat

Get a Job Like These Earn \$3500 to \$10,000 a Year

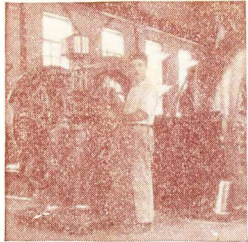

20 Years Old— Makes Almost \$500 a Month

Harold Hastings of Somers, Mass., says: "The profit on my electrical business amounts to \$475.00 a month. My success is due entirely to your instruction. You make your men just what you say—Electrical Experts. No man will ever make a mistake enrolling for your course."

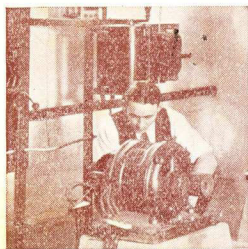

Dickerson Gets \$7500 a Year

"I earned \$30 a week when I started with you—\$50 a week when half through your course. Now I clean up at the rate of \$7500 a year. Thank you a thousand times for what you did for me. Electricity pays big on the farm." Herbert M. Dickerson, Warren-town, Va.

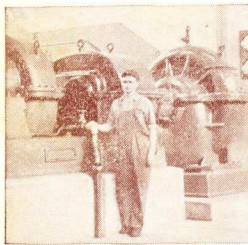

\$20.00 a Day for Schreck

"Use my name as a reference and depend on me as a booster. The biggest thing I ever did was answer your advertisement. I am averaging better than \$500 a month from my own business now. I used to make \$18.00 a week." A. Schreck, Phoenix, Ariz.

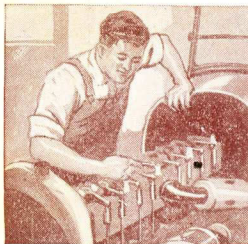

Pence Earns \$9000 a Year

W. E. Pence, Chehalis, Wash., says: "Your course put me where I am today, Mr. Cooke—making \$750 a month doing automobile electrical work—think of it—\$9000 a year. Besides that I am my own boss. My wife joins me in thanking you for what you did for us."

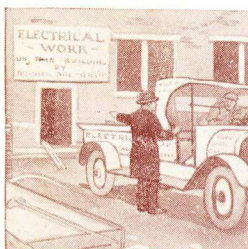

\$30 to \$50 a Day for J. R. Morgan

"When I started on your course I was a carpenter's helper, earning around \$5.00 a day. Now I make from \$30 to \$50 a day and am busy all the time. Use this letter if you want to—I stand behind it." J. R. Morgan, Delaware, Ohio.



Spare Time Work Pays Stewart \$100 a Month

"Your course has already obtained a substantial increase in pay for me and made it possible for me to make at least \$100 a month in spare time work. You can show this at the weak fellows who haven't made up their minds to do something yet." Earl Stewart, Corona, Calif.

in the Big Pay Field of **ELECTRICITY**

It's your own fault if you don't earn more. Blame yourself if you stick to your small pay job when I have made it so easy for you to earn \$3500 to \$10,000 a year as an electrical expert. Electrical Experts are badly needed. Thousands of men must be trained at once. One billion dollars a year is being spent for electrical expansion and everything is ready but the men. Will you answer the call of this big pay field? Will you get ready now for the big job I will help you get? The biggest money of your life is waiting for you.

I Will Train You at Home

I will train you just like I trained the six men whose pictures you see here. Just like I have trained thousands of other men—ordinary, everyday sort of fellows—pulling them out of the depths of starvation wages into jobs that pay \$12.00 to \$30.00 a day. Electricity offers you more opportunities—bigger opportunities—than any other line and with my easily learned, spare time course, I can fit you for one of the biggest jobs in a few short months' time.

Quick and Easy to Learn

Don't let any doubt about your being able to do what these other men have done rob you of your just success. Pence and Morgan and these other fellows didn't have a thing on you when they started. You can easily duplicate their success. Age, lack of experience or lack of education makes no difference. Start just as you are and I will guarantee the result with a **signed money back guarantee bond**. If you are not 100% satisfied with my course it won't cost you a cent.

Free—Electrical Working Outfit and Tools

In addition to giving my students free employment service and free consultation service, I give them also a complete working outfit. This includes tools, measuring instruments, material and a real electric motor—the finest beginners' outfit ever gotten together. You do practical work right from the start. After the first few lessons it enables you to make extra money every week doing odd electrical jobs in your spare time. Some students make as high as \$25 to \$35 a week in spare time work while learning. This outfit is all FREE.

Mail Coupon for FREE BOOK— The Vital Facts of the Electrical Industry

The coupon below will bring you my big free electrical book—over 100 interesting pictures. The real dope about your opportunities in electricity—positive proof that you, too, can earn \$3500 to \$10,000 a year. Send for it now. Along with the book I will send you a sample lesson, a credit check allowing you a \$45.50 reduction, my guarantee bond and particulars of the most wonderful pay-raising course in the world. Send the coupon now—this very second may be the turning point in your life. Send it while the desire for a better job and more money is upon you, to

L. L. COOKE, Chief Engineer

Chicago Engineering Works

DEPT. 2150 Lawrence Ave., Chicago

The Cooke
Trained Man
is the Big
Pay Man



L. L. COOKE, Chief Engineer, Dept. 97-A
Chicago Engineering Works, 2150 Lawrence Ave., Chicago, Ill.
Without obligating me in any way send me the "Vital Facts of the Electrical Industry" book, Sample Lessons and Particulars of your Free Book, Sample Lessons and Particulars of your Free Outfit. Other Free Employ-ment Service and Proof that you can fit me for a big-pay electrical job.
Name _____
Address _____

"WORKRITE"

TUNER TEAM

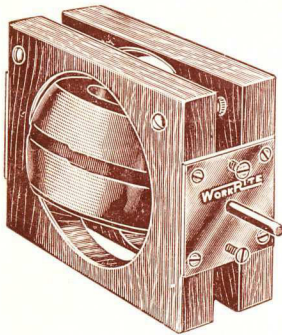

Here it is—The Workrite Tuner Team—the most selective circuit possible. Two Workrite Super Variometers made from polished mahogany and a Workrite 180° Super Variocoupler made from molded Bakelite make up this wonderful team. Let the Workrite Tuner Team get your station for you. Just look at these extremely low prices.

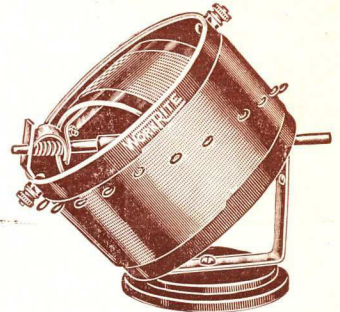

Workrite Super Variometer..... Each \$3.50
Workrite 180° Super Variocoupler

NEW WORKRITE SUPER VERNIER RHEOSTAT \$1.00

This instrument is the last word in Rheostats. 50,000 possible adjustments for \$1. The drum is molded and cannot shrink. No danger of the wires loosening.

Easy to mount on panel. Pushing the knob way in turns off filament. Turning the knob gives the very finest adjustment. Often a turn of 1/32 inch will clear up a station or separate two stations.

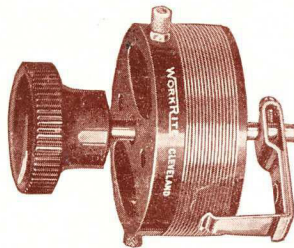

The Workrite Super Vernier Rheostat is made with three different resistances so that there is a Workrite Rheostat that will work with any Tube now on the market.

Workrite Vernier Rheostat
6 ohms\$1.00
Workrite Vernier Rheostat
15 ohms\$1.10
Workrite Vernier Rheostat
30 ohms\$1.25

WORKRITE UV 199 TUBE ACCESSORIES ARE BEST

WORKRITE RESISTANCE CARTRIDGE



No need to buy a new Rheostat to get the 30 ohms resistance required for the UV 199 Tubes, or the 15 ohms for the 201A and 301A Tubes. Just put a Workrite Resistance Cartridge on the circuit with your old 5 or 6 ohm Rheostat. Price 15 or 25 ohm40c

WORKRITE NON-MICROPHONIC SOCKET

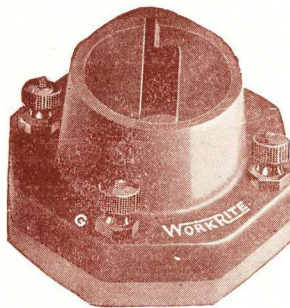

Here is the right socket for your new UV 199 Tube. It is molded with a sponge rubber base in one piece, which is even better than the soft rubber recommended for use with this tube. Price.....60c

WORKRITE Hydrometer

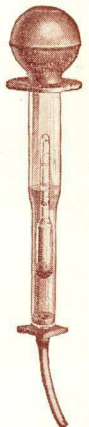

Double the life of your battery by giving it proper care. Fill and test it regularly with a Workrite Hydrometer. Never let it get below 1150. Full instructions for testing and care of battery with each "Workrite." Get one now. Price.....75c

OTHER WORKRITE RADIO PRODUCTS

Workrite E-Z-Tune Dial. Has a knurled flange on outer edge, giving firm grasp for fine tuning. Price75c
Workrite Concertolas. Loud Speakers of Quality. Carefully made.
Workrite Concertola, Jr.\$12.00
Workrite Concertola, Sr.\$18.00

Workrite Switch Set. Complete switch set in one unit. Parts made to work together. Use block for template in drilling panel. Price.....50c
Workrite Head Set. Extremely sensitive and free from distortion. Compare it with any one the market. Price\$6.00

"WORKRITE RADIO PARTS WORKRITE"

THE WORKRITE MFG. CO. 5520 Euclid Ave., CLEVELAND, Ohio
BRANCH OFFICE: 536 Lake Shore Drive, Chicago, Ill.

This file including all text and images are from scans of a private personal collection and have been scanned for archival and research purposes. This file may be freely distributed, but not sold on ebay or on any commercial sites, catalogs, booths or kiosks, either as reprints or by electronic methods. This file may be downloaded without charge from the Radio Researchers Group website at <http://www.otrr.org/>

Please help in the preservation of old time radio by supporting legitimate organizations who strive to preserve and restore the programs and related information.